TABLE OF CONTENTS

Subject	Page
Introduction	2
Instrument Cluster (IKE).	4
Base Instrument Cluster	5
Dynamic Digital Inputs	8
Analog Inputs	9
Digital Inputs	10
Output Signals	11
High IPO	12
Base IPO	13
Light Check Module III (LCM III)	14
• Lamp Control / Monitoring	15
• Replacement Lighting	16
• Redundant Data Storage	17
Check Control	18
Multi-Information Display	20
• MID Self Test	22
• MID Removal	23
On Board Computer	24
BC Test functions	26
Base BC/Instrument Cluster Test Functions.	27
Heated Steering Wheel Feature	34
Audio System	35
Mark II Navigation System	36

Introduction

Depending on the model and equipment installed, the X5 is equipped with either the high version E38/E39 or the base version Instrument Cluster - Driver information systems. The wiring harness is similar to the E38/E39 systems with minor changes made for functional changes with control modules.

The X5 continues to make use of multi-information bus communication systems. They offer the advantages of:

- A high level of reliability
- Reduction in the size of the harnesses
- Multiple utilization of sensor and signal inputs
- Expanded functions through increased data flow
- Flexibility in configuring the systems
- Reduction in cost
- Expanded diagnostic capabilities

The CAN bus link to the Instrument Cluster provides expanded communication for all vehicle functions to share engine/drivetrain data with the body electrical systems. The cluster is an important link in the system, and vital information is updated faster to the control modules.

IKE LOW

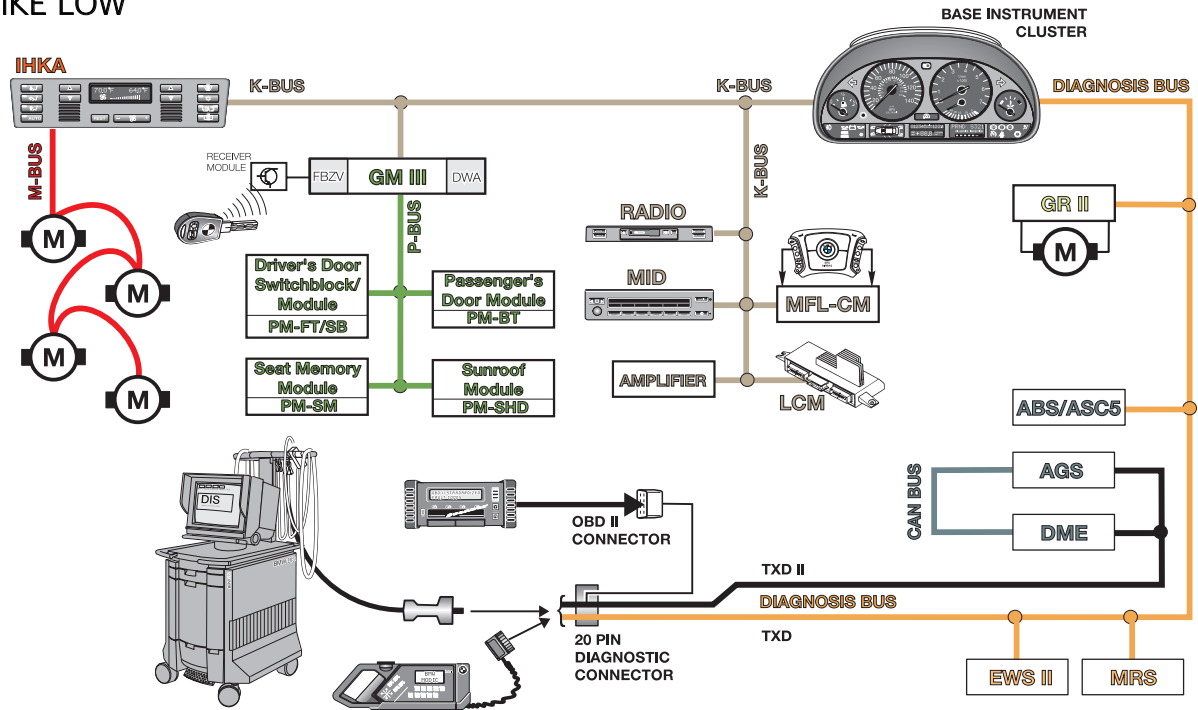

63530005

IKE High

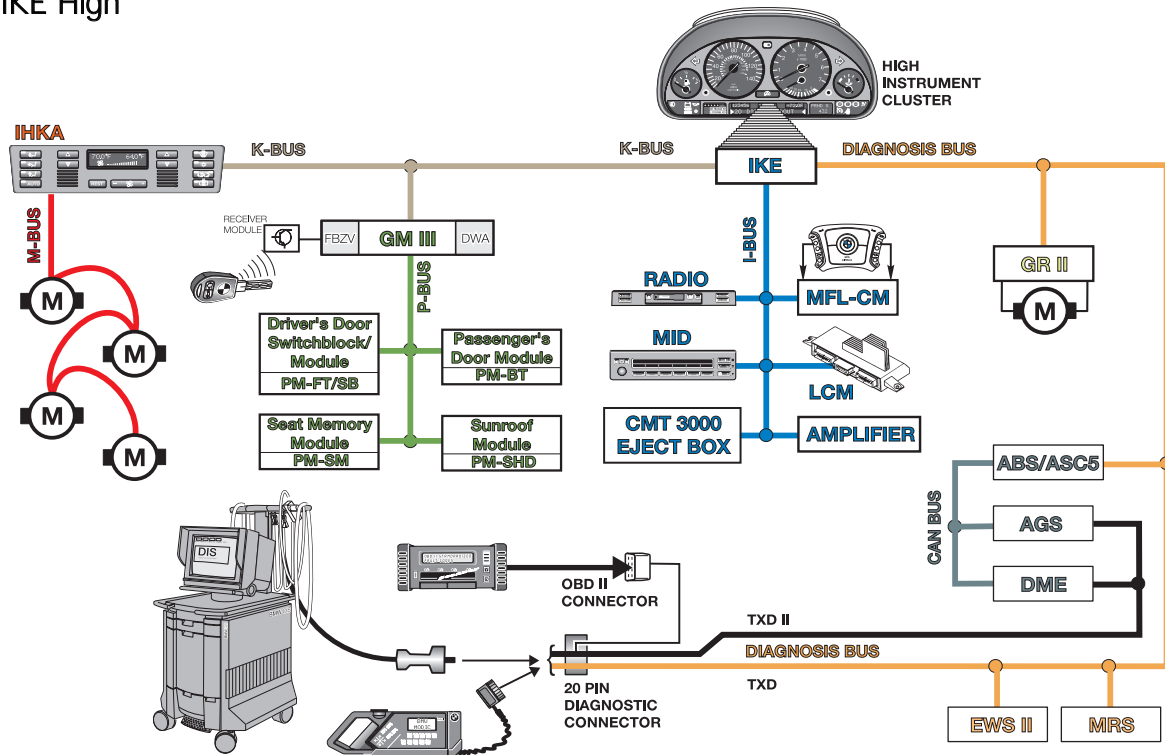

63530006

High Instrument Cluster (IKE)

The IKE corresponds to the E38/E39 system. It consists of the integrated control electronics and the Display Unit. The IKE is the data gateway for the I, K and CAN Busses. The IKE is also the gateway for diagnostic messages that are sent to and from the DIS tester and all of the modules on both the "I" and "K" busses.

The "CHECK ENGINE" light nomenclature has been changed to "SERVICE ENGINE SOON".

Redundant data storage for the total mileage and service interval indicator is stored in the LCM III.

All gauge functions, warning lamp indicators and the matrix display are the same as in the E38. The needle of the coolant temperature gauge is centered if coolant temperature is between 75° C - 115° C.



The fuel economy indicator returns to its starting point when road speed is reduced to 5 MPH and doesn't move again until road speed is above 8 MPH. Certain indicator/warning lights are illuminated momentarily when KL15 is switched on as a pre-drive check. The indicators will switch off after 2 seconds or within 1 second after the engine starts.

Base Instrument Cluster

The base instrument cluster consists of five analog gauges. The processing electronics and drivers for the gauges are contained in the cluster. The five gauges include:

- Fuel Gauge
- Speedometer
- Tachometer
- Fuel Economy Gauge
- Coolant Temperature



62530004

Three Liquid Crystal Display blocks are provided for the:

- Check Control Display - pictogram
- Mileage, Outside Temperature and BC Display
- Transmission Range and SI Display

Warning lamps and indicators are positioned to the left and right of the display blocks. The number of warning lamps is greater on the base cluster for the display of several check control warnings. All of the warning lamps and indicators are LEDs and not replaceable. Critical warning lamps use two LEDs for a safety margin.

The **LEFT DISPLAY BLOCK** contains a pictogram for various check control warnings. LEDs within the display will illuminate for:

- Lighting failures for headlight (low beam), taillight and brake lights.
- Open doors or trunk
- Low washer fluid

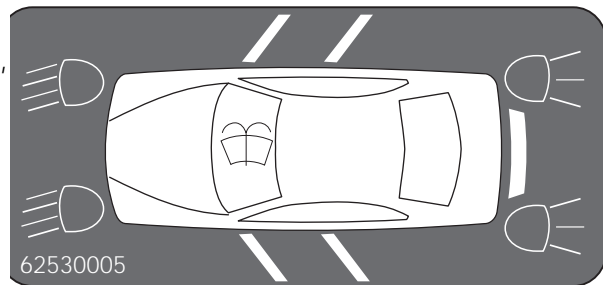

Additional circuits monitored by check control include the engine oil level and transmission emergency program. These warnings are indicated by lamps positioned in both indicator display areas on the left and right sides on the bottom of the instrument cluster.

Due to the ability to illuminate multiple warning LEDs, there is no priority displays for the pictogram check control. If multiple faults exist, each corresponding LED will illuminate.

The LED will remain illuminated as long as the fault exists. The only exception is the washer fluid which will go out 60 seconds after KL 15 is switched ON.

All check control and lamp control circuits are monitored by the Light Check Module (LCM). When failures or faults exist, the messages are passed to the cluster for display over the K-Bus.

The **MIDDLE BLOCK** contains the displays for the Total Mileage, Trip Mileage and Board Computer.

The total mileage is stored in non-volatile memories in the cluster EEPROM and the LCM.

The mileage can be displayed with the key off for 25 seconds if the mileage reset button is pressed.

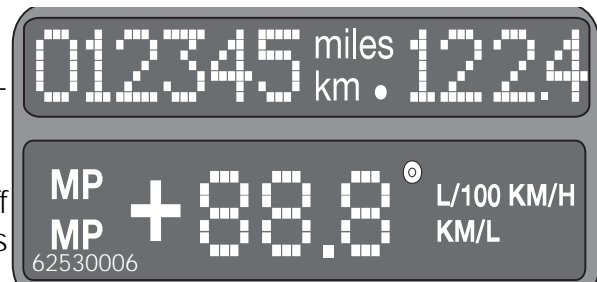

Board Computer information can be displayed by pressing the turn signal lever.

NOTE: The outside temperature is displayed automatically every time the key is switched ON.

The **RIGHT BLOCK** contains the displays for the automatic transmission driving range and the Service Interval Indicator III. The display of the Service Indicator on the E39 is the same as previous systems.

The processor for the intervals is located in the cluster electronics. However, the processing method for determining interval times has changed. The E39 uses the new Service Interval III system. Interval times are based on fuel consumption instead of mileage and starts. This system was introduced on the 1996 E38 - 750iL and is now being phased into the other models.

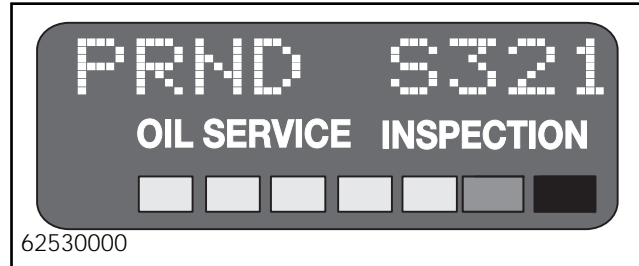

Using fuel consumption offers several advantages over the previous method for determining oil service.

- First, the processing electronics are less involved in that only one value is needed for the processing.
- Second, the use of fuel consumption is a more accurate method of determining engine load and the need for service.
- Third, resetting of the indicator before the scheduled time will not effect the time to the next service.

A set volume of fuel (in liters) is stored in the EEPROM of the SI. The volume of fuel is dependent on the vehicle and engine size. The processor receives the "ti" signal as the vehicle is used. As 20% of the stored volume is consumed, one of the green LEDs will go out. Each successive 20% of fuel consumption will cause the next LED to go out until 100% of the stored volume has been consumed. At this point the yellow LED will come on indicating the service is due. At 108% of the volume, the RED LED will illuminate indicating an over due service. With each reset (oil service ore inspection), the total volume of fuel is restored in the EEPROM and the calculation starts over again.

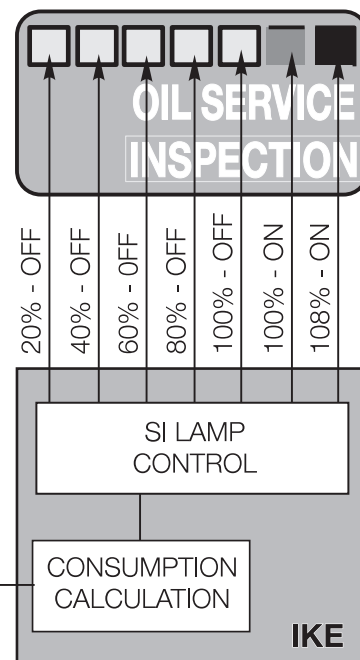

62530007

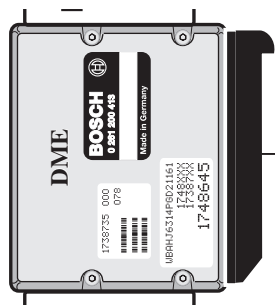

TI SIGNAL



DYNAMIC DIGITAL INPUTS

DISTANCE SIGNAL- This input is supplied to the cluster by the DSC control module as a square wave signal. Pulses from the wheel speed sensors are processed by the DSC module to produce this signal.

The cluster electronics process the input for the cluster display and pass the signal along, on the I & K busses, as speed signal "A" for other control modules requiring the vehicle speed signal.

CAN BUS SIGNALING - The CAN bus connection to the instrument cluster is found at pins 8, 9 and 10 of the blue 26 pin Elo connector on the back.

The signals transmitted from over the CAN bus to the instrument cluster include:

- Engine temperature
- Engine rpm
- Ti signal (fuel economy indicator)
- Check engine lamp activation
- Transmission range selector position and driving program.

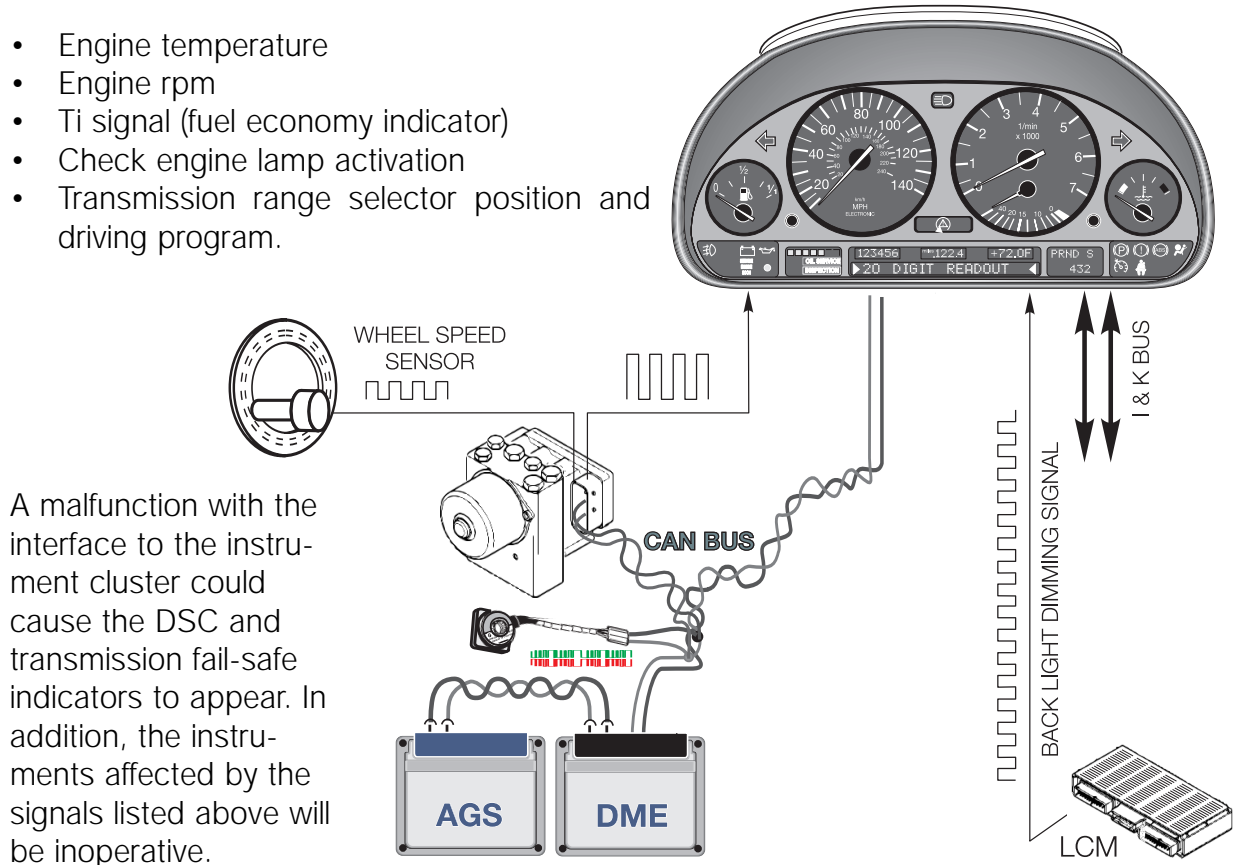

A malfunction with the interface to the instrument cluster could cause the DSC and transmission fail-safe indicators to appear. In addition, the instruments affected by the signals listed above will be inoperative.

DIMMER SIGNAL - This is a pulse-width modulated signal from the LCM. It is used to control the intensity of the back lighting of the instruments and the LCDs when the lights are switched ON. This signal is also output over the "K" Bus.

ANALOG INPUT SIGNALS

BATTERY VOLTAGE - Battery voltage is monitored by the cluster and a fault is stored if the voltage exceeds 16 volts

FUEL TANK LEVEL - Two lever action sensors are wired in parallel to the cluster. The two varying voltage signals are processed by the cluster for fuel gauge and low fuel warning display.

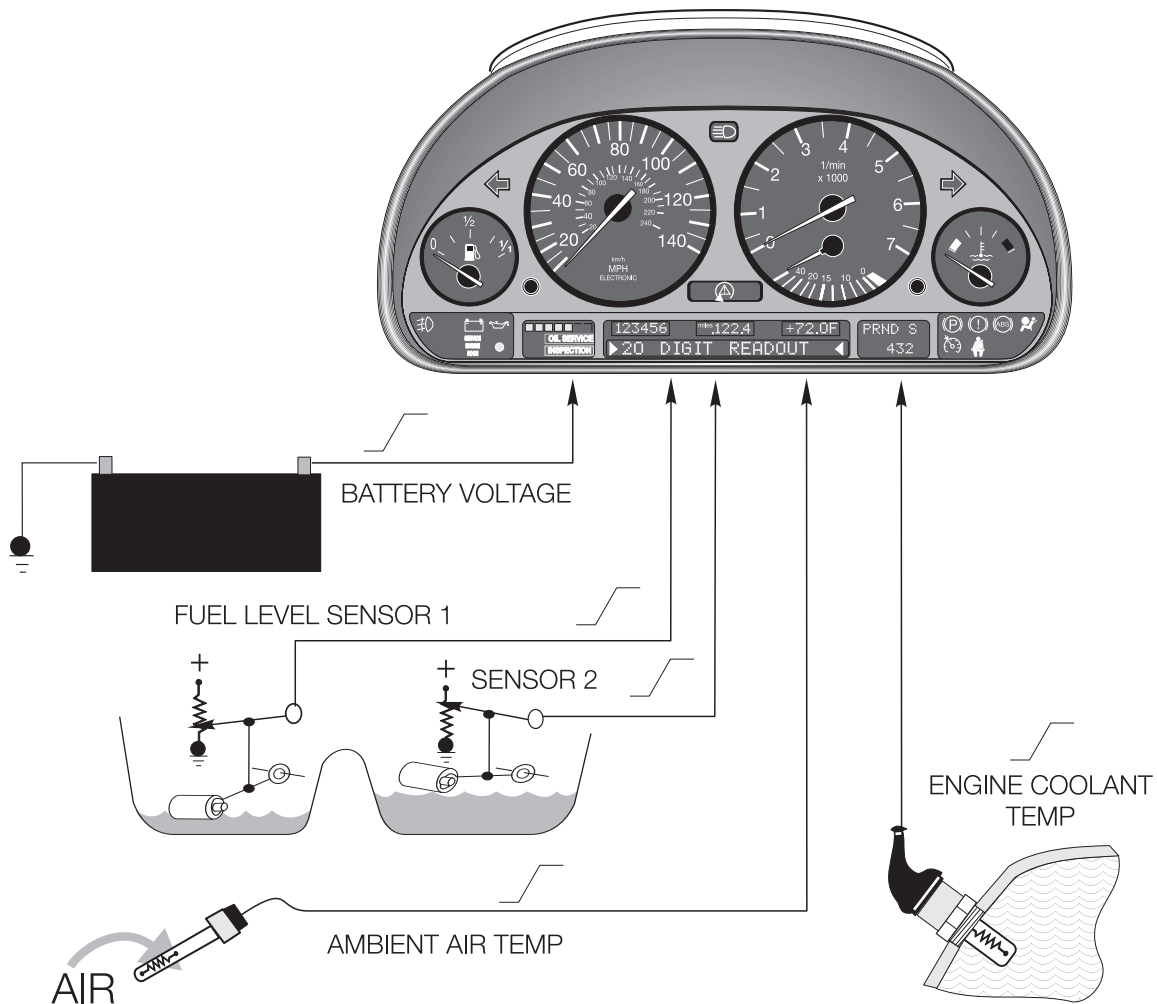

COOLANT TEMPERATURE - A NTC sensor is used to measure coolant temperature. the cluster uses this input for temperature gauge display.

OUTSIDE TEMPERATURE SENSOR - A NTC sensor is used to measure the ambient temperature. The signal is processed by the cluster and passed out over the K Bus to modules requiring this input for processing.

DIGITAL INPUT SIGNALS

The normal ignition switch terminals (**KL R, KL 15 & KL 50**) are input to the cluster. Various functions are dependent on ignition switch position.

STEERING COLUMN SWITCH - As with previous systems the turn signal stalk is used to call up BC functions.

BRAKE PAD WEAR SENSORS - The pad sensor inputs are used to illuminate the brake pad warning indicator as in the past.

INSTRUMENT PANEL BUTTON - The reset button is used to reset the trip - odometer as in the past. It will also display the mileage, if pressed with the key switched OFF. This button is also used for the Base BC/instrument cluster test functions outlined on page 15.

INPUTS FOR WARNING LAMPS - Various switches are used to signal the cluster for warning and indicator lamp illumination.

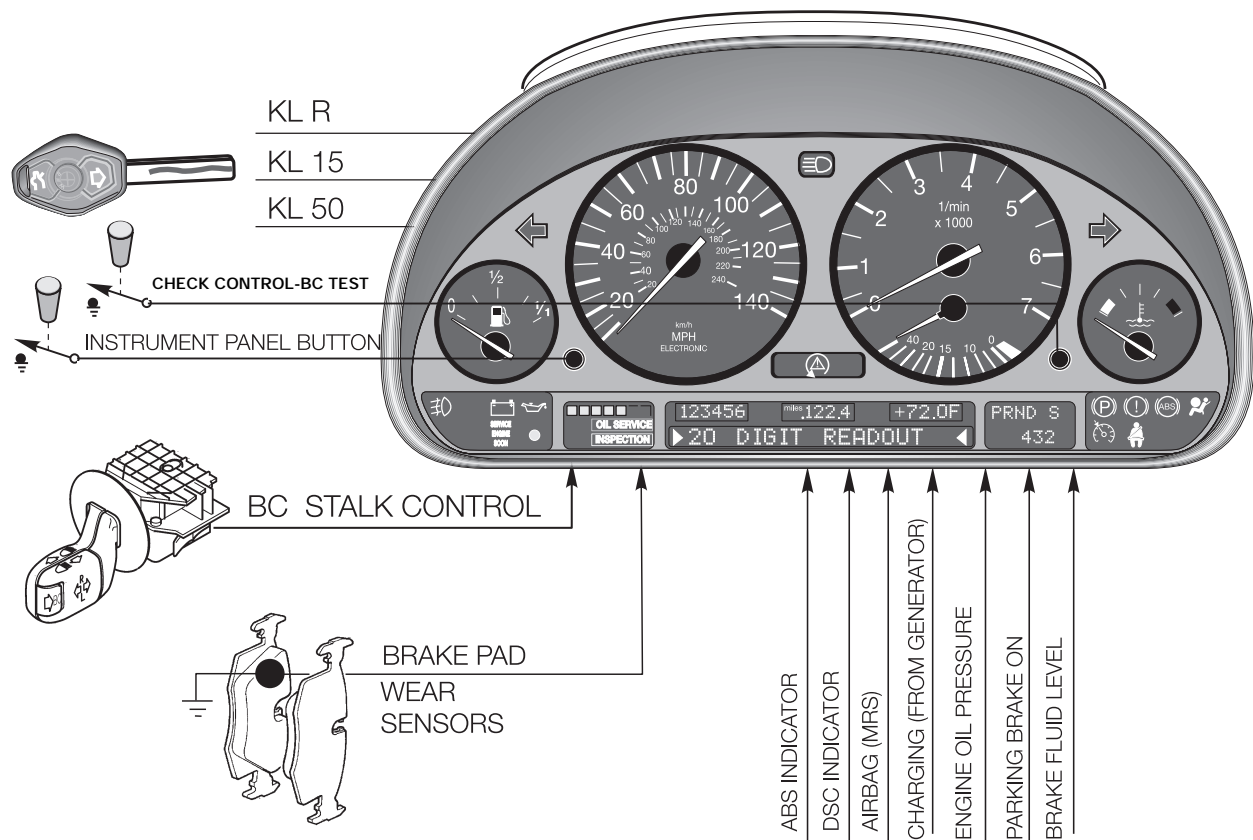

OUTPUT SIGNALS

I & K BUS INTERFACE - The K Bus is used to transfer data between the cluster and other modules on the link. The diagnostic interface also passes over the K Bus for troubleshooting with the DIS Tester.

Gong Outputs T 1 , T 2 , T 3

- T 1 - Activates memo (hourly reminder)
- T 2 - Activates the tone for the freeze warning
- T 3 - Activates the tone for check control functions
- T 1 -T 2 - Activated simultaneously produces the tone for code and limit functions.

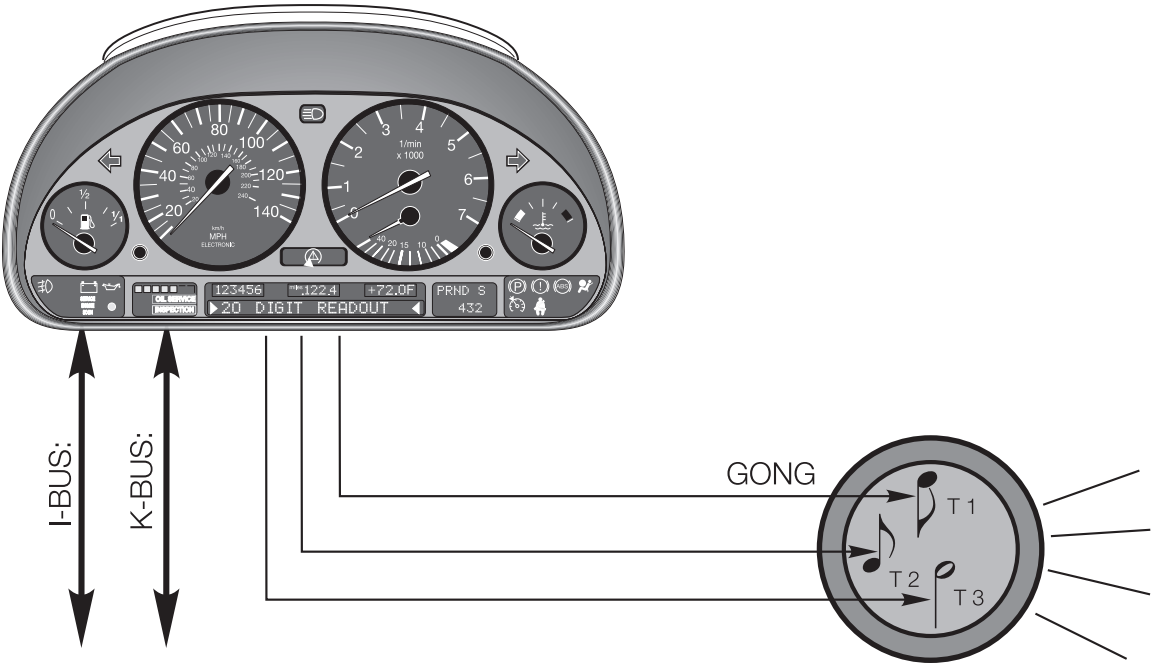

High Instrument Cluster

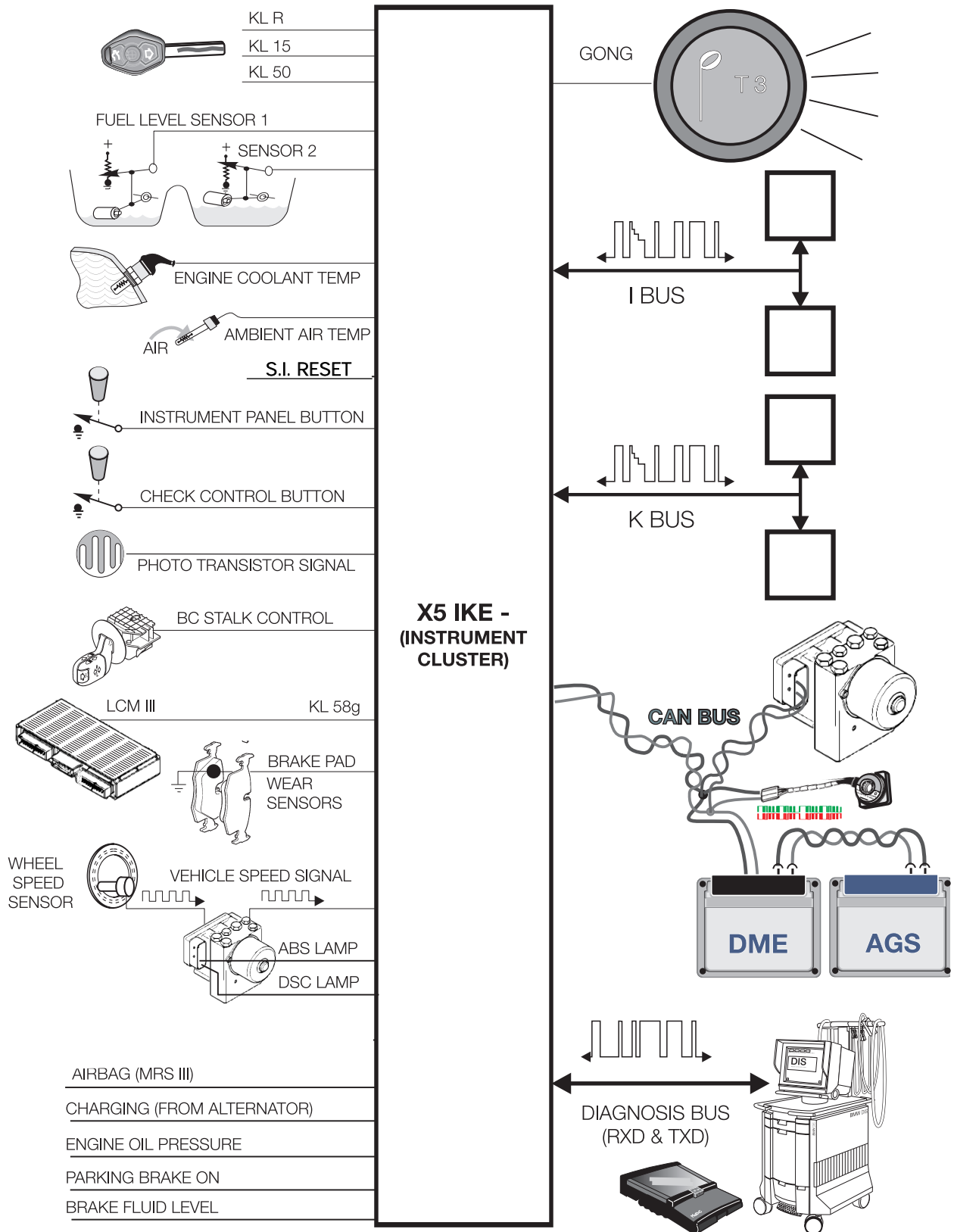

Base Instrument Cluster

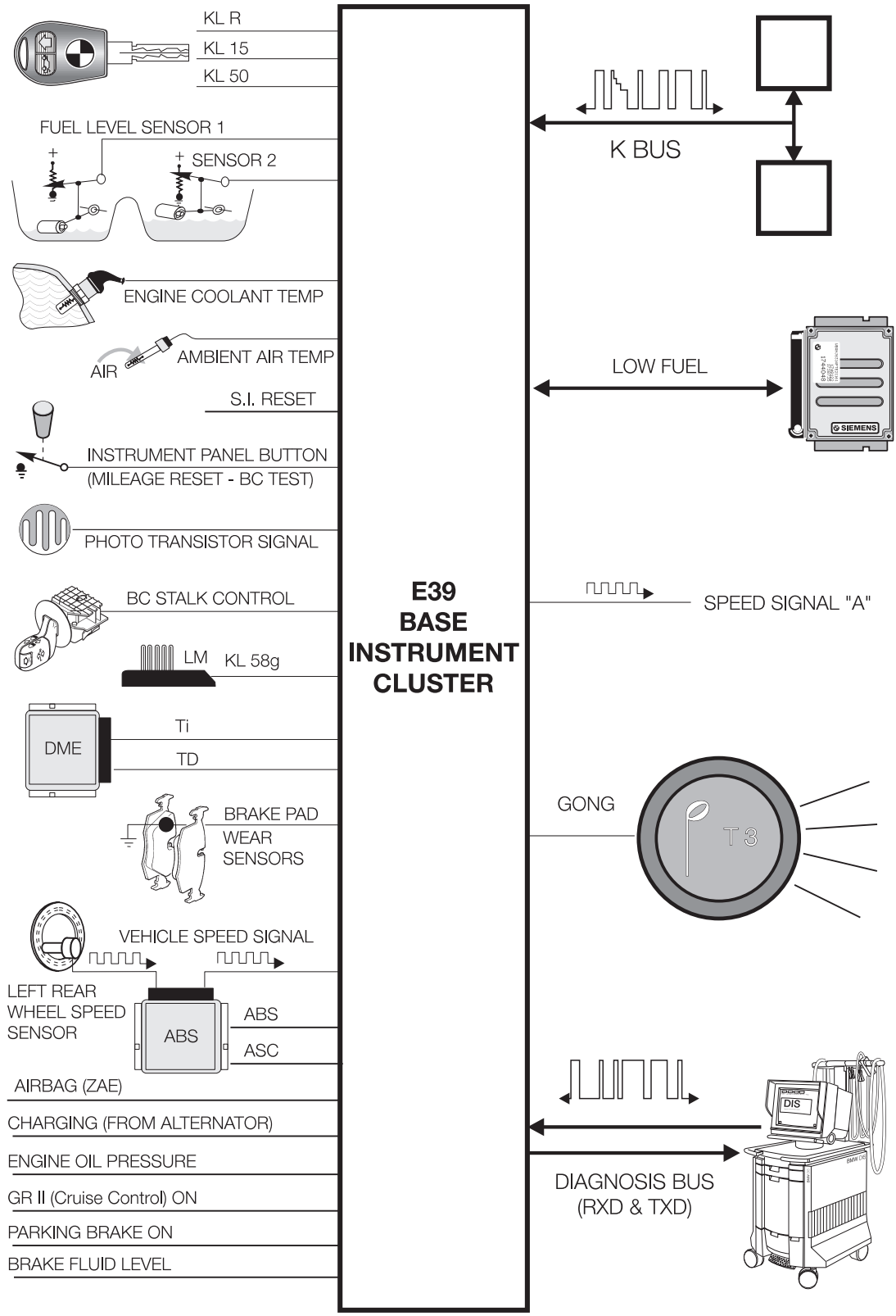

LIGHT CHECK MODULE III (LCM III)

The LCM III continues to be installed in the right kick panel. The LCM communicates with other modules over the "I" and "K" busses. The module itself has been redesigned with new semi-conductor final stages that produce less heat in operation. This has allowed for the elimination of the protruding heat sink found on the previous LCM.

Functions of the LCM include:

- Monitoring of all check control inputs
- Formation and output of check control messages or signals
- Control of all vehicle external lighting
- Monitoring of all external lighting for operation
- Instrument panel illumination dimming (KL 58g) signal
- Control of instrument cluster indicator lights - for high beam, turn signal and fog light indicators.

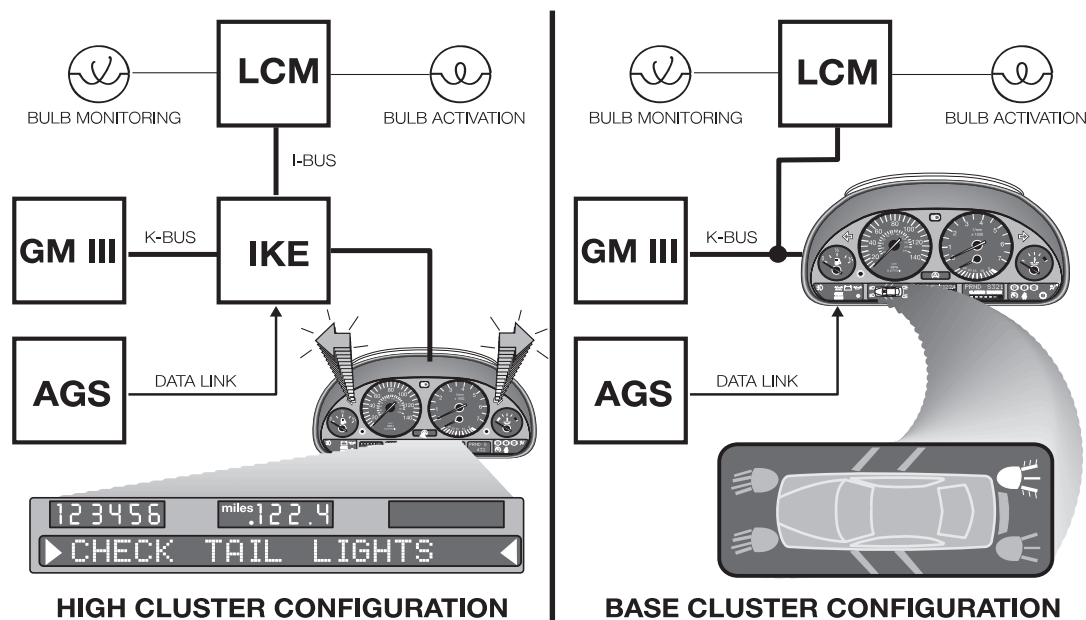

For Proper Operation of the check control and lamp control functions, the LCM must be coded with the Central Key (ZCS) if replacement is required.

LAMP CONTROL/MONITORING

Lamp control and monitoring on the X5 follows the E38 in design and function. All exterior lighting is controlled by the LCM. It contains transistor power output stages for activating the lights. This eliminates the need for fuses and relays previously used for this purpose.

The LCM receives the input request for light illumination from the various switches and data inputs from other control modules. The LCM then switches the power output stages ON for lamp activation.

Other control modules that communicate with the LCM include:

- IKE over the I/K bus for turn signal, highbeam and fog lamp indicator illumination.
- The ZKE for crash alarm indication.
- The AGS control module for back up lamp activation.

All exterior lighting is monitored (both hot and cold) by the LCM. When the monitored value exceeds an acceptable level (high or low) the LCM generates and sends the signal to the IKE or base instrument cluster for check control display.

- Hot monitoring takes place from the LCM by monitoring the current flow through the output stages.
- Cold monitoring takes place by the LCM by briefly switching the lights ON and monitoring the current flow through the output stages. This is not enough to cause the lights to illuminate.

For safety purposes, the LCM is designed with emergency functions. A LCM failure will still allow various lamps to function for safety purposes. These lamps include:

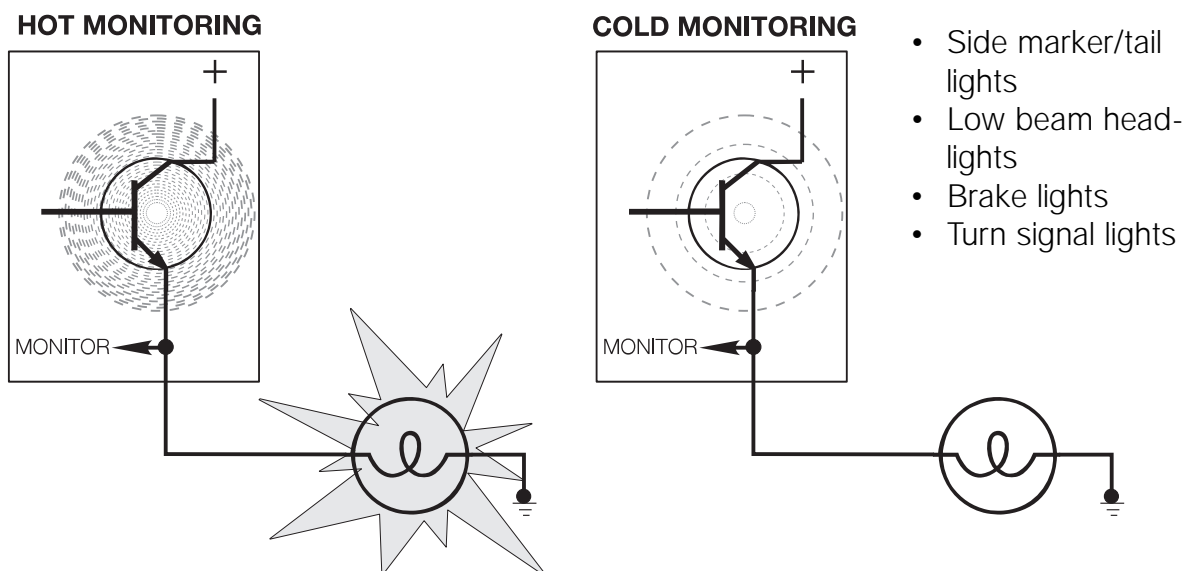

REPLACEMENT LIGHTING

The LCM uses substitute bulbs for various lights if a failure should occur, for example:

Front Parking Lights: If one of the parking lamps should fail, the LCM will illuminate the turn signal bulb on the affected side. The lamp will be dimmed by the LCM so that the intensity is the same as the parking lamp.

Taillights: If one of the taillights should fail, the LCM will switch on the brake lamp on the affected side. The lamp will be dimmed to the intensity of the tail lamp.

OUTPUT VOLTAGE LIMITING FUNCTION

The output voltage applied to the parking and tail lamps is regulated to increase the life of the lamps. If the voltage at the LCM increases over 12,5 volts, the LCM will reduce the voltage to 12 volts.

FOLLOW ME HOME LIGHTING

This convenience feature provides lighting for the driver and passengers to leave the vehicle and enter their homes.

The feature is switched "ON" by pulling the headlight flasher switch after the headlights and ignition have been switched OFF. The feature is switched OFF after a coded time delay or by switching the ignition ON.

REDUNDANT DATA STORAGE

The specific information stored redundantly includes:

- Vehicle ID number
- Total mileage
- Service Interval data

The data is stored in the cluster and in the Light Check Module (LCM). The storage of this data follows the redundant storage of the E38. It prevents the loss of total mileage or SI data in the event of a cluster processor failure.

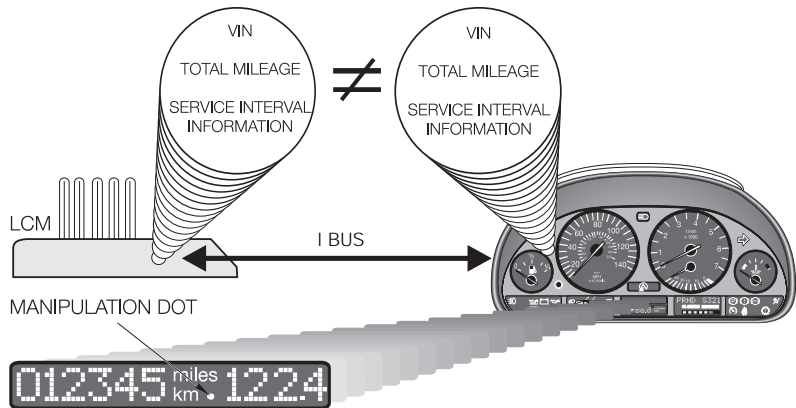

The data is compared each time KL 15 is switched ON. If the data does not match, the manipulation DOT in the mileage display is illuminated.

Because of this redundant storage feature, the following points must be noted:

1. If the vehicle ID number is not the same in both modules, the manipulation DOT is illuminated and no data transfer takes place. All functions of both modules will continue to operate.
2. Data will only be accepted by the cluster from the LCM if the ID numbers match and the cluster mileage is zero.
3. The vehicle ID number is input into the cluster through coding and will only be accepted when the cluster is at zero mileage.
4. The LCM stored mileage can only be overwritten with a higher mileage and is updated every 60 miles.
5. If the mileage differs by more than 120, and the ID numbers are the same, the cluster will continue recording the mileage and set a fault for data transfer.
6. If the I Bus link to the LCM fails, the cluster will continue to record mileage and store a fault for the data link.

These conditions will only allow new components to be installed for replacement purposes. However, a used component can be installed for testing purposes. If a cluster from another vehicle is used for testing purposes, road testing of the vehicle should be avoided, because the cluster will accumulate mileage.

CHECK CONTROL (High Cluster)

The Check Control system corresponds to that of the E38/E39 in function and operation. The LCM collects and evaluates all check control data inputs from the various switches and sensors. This includes the lamp monitoring function within the same module. The failure or warning messages are formed in the LCD and transmitted to the IKE over the "I" bus for display in the cluster matrix.

The cluster matrix contains a 20 character display field for posting messages. Failures and warnings are prioritized for display following the same criteria as the E38.

Priority P1 - Critical or important warnings that cannot be canceled with the CC button.

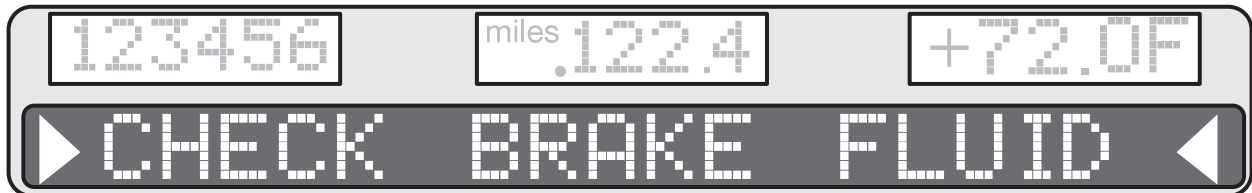

Priority P2 - Messages that are displayed when KL 15 is switched on for a maximum of 23 seconds or when the failure occurs for while driving.









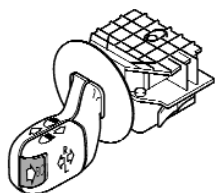



Priority P3 - Messages that are only displayed at the start of or end of a trip.



Special Warnings: These are top priority messages and won't be overridden when displayed. Seatbelt, ignition key in lock with door open are some of these messages.



The CC button or steering column switch can be used to call up or cancel P2 or P3 messages.

DISPLAY	GONG	PRTY	SCOPE OF MONITOR
OPERATING CONDITIONS			
Release Parking Brake		P1	Warning displayed above 3 MPH
Door open with ignition key in position KL 15		S	Warning displayed when a door is open or opened above 3 MPH.
Trunk Open		P2	Warning displayed above 3 MPH when trunk opens or was left open prior to pulling away. Displayed once only.
Stop! Engine oil pressure		P1	Warning displayed oil pressure has fallen below safe level.
Coolant Temperature		P1	Warning displayed when coolant rises above maximum temperature
Check Brake Lights		P2	The LCM monitors certain vehicle lights and circuits. When a fault is detected the IKE is notified to post the display.
Check low-beam headlights			
Check high-beam headlights			
Check parking lights			
Check front fog lights			
Check license plate lights			
Check brake pads		P2	Warning issued when brake pad wear limit is reached.
Lights on?		P3	Warning displayed when key is in position 0 if driver's door is opened with light switch on.
Ignition key in lock		S	Warning is displayed when key is left in ignition switch in position R or 0.
Fasten Seatbelt		S	Warning is displayed for a 6 second period after "Ignition on" with seatbelt fastened or not. If seatbelt is fastened the intermittent gong is switched off.
Remote Battery		S	When remote key battery voltage drops below 4.5 volts
FLUID LEVELS			
Check Brake Fluid		P1	Warning is displayed when brake fluid is too low.
Check engine oil level		P2	Warning is displayed when the engine oil level is too low.
Check coolant level		P2	Warning is displayed when coolant level is too low. The warning is only posted when the ignition key is first turned on.
Add washer fluid		P2	Warning is displayed when washer fluid level is low. This warning is displayed at any time the level becomes low to provide an early warning
<p>NOTE: The fluid level warnings are monitored in 25 second intervals. This time interval prevents false displays from occurring due to bumpy roads, fluid sloshing, etc.</p>			
CONTROL SYSTEM FAULT DISPLAYS			
Emergency transmission operating program		P2	If a fault occurs in the AGS control system check control displays the message. The message is originated from the AGS CM to IKE over a one way serial data line. From there IKE notifies the LCM over the I Bus.
EEPROM IKE		S	When IKE and LCM data differ (for testing purposes).

MULTI-INFORMATION DISPLAY (MID)

The X5 utilizes the E39 MID for control and display of the radio/tape/CD changer and clock. The MID itself, does not perform any calculations, it is only an input/display device.

If installed, the Digital Sound Processor (DSP) will also be adjusted and controlled through the MID.

Additionally, with the high version cluster, the MID will also be used as the control and display for the Board computer and telephone.

The MID contains two sets of displays

MAIN DISPLAY - A 32 character display for presentation of primary information.

MENU DISPLAY - 6 small display blocks above each button switch for labeling the switch functions.

HIGH VERSION FOR USE WITH HIGH CLUSTER

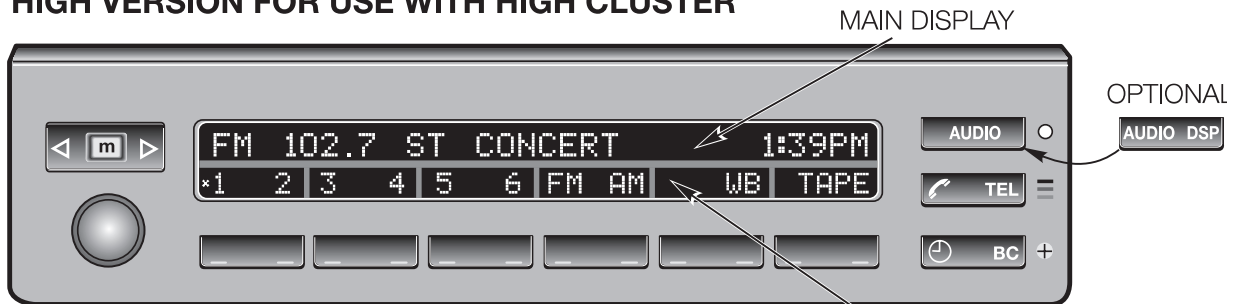

BASE VERSION FOR USE WITH BASE CLUSTER

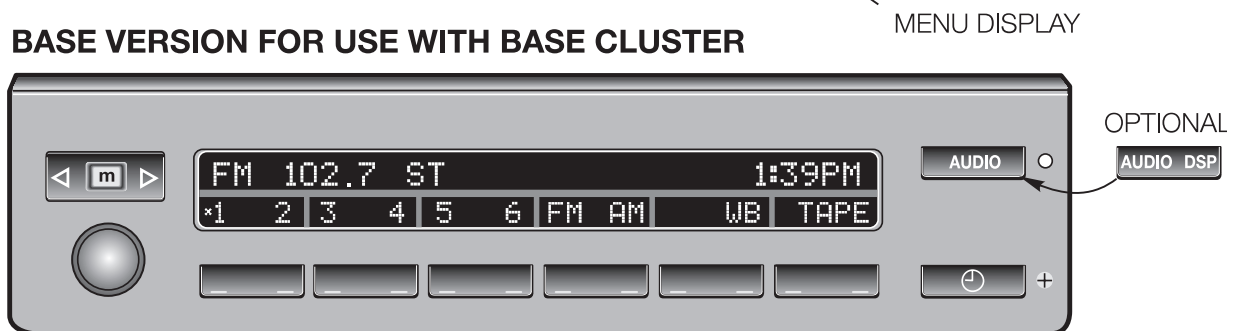

65530000

MENU BUTTONS - the buttons are designed as rocker switches having a left and right side contact. The function of each button changes as the different systems are selected.

SELECTOR BUTTONS - These buttons are used to select the desired system to be used:

- **Audio** - calls up the radio/tape/CD control functions for operation and programming.
- **Telephone** - used to program and call up stored telephone numbers.
- **Time/BC** - calls up the clock and BC control functions for programming and display.

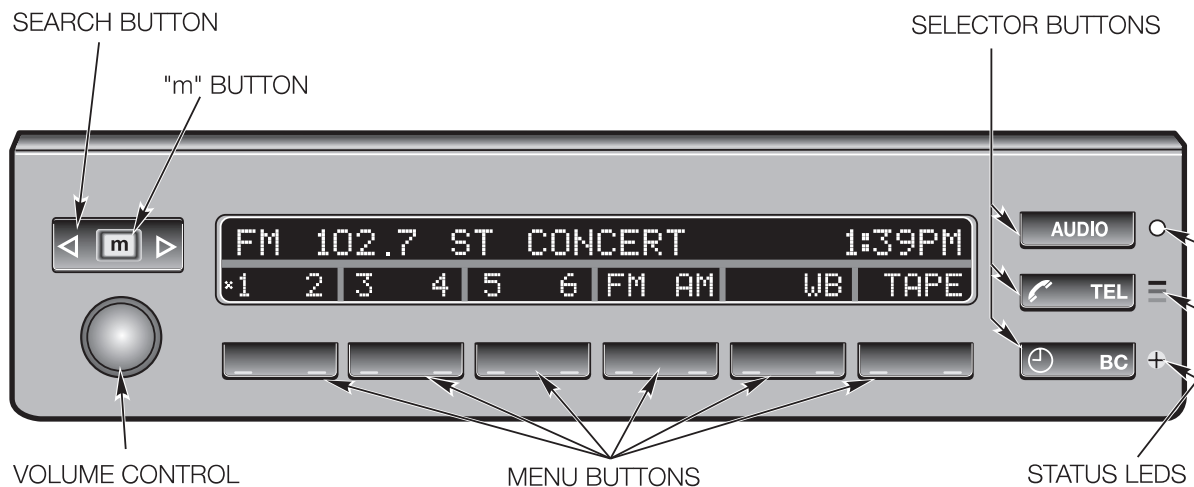

SEARCH BUTTON -

- **Radio** - will activate the search for radio stations in either direction
- **Tape** - activates music search in forward or reverse directions.
- **CD** - activates title search up or down the music list.

The integrated "m" button is used to switch over to a "manual" search of the functions listed above. An "m" is posted in the display when in this mode. The "m" button is also used to activate the radio test.

VOLUME CONTROL

- Push button for ON/OFF control of audio system.
- Rotary knob for volume control on the audio system and telephone hands-free speakers.

STATUS LEDs

- Red, yellow and green LEDs indicate status of telephone operation.
- A red fan symbol indicates the status of the parked car ventilation system's operation.

MID SELF TEST

Operation of the MID can be checked through the test function sequence on the MID panel. The following items can be checked:

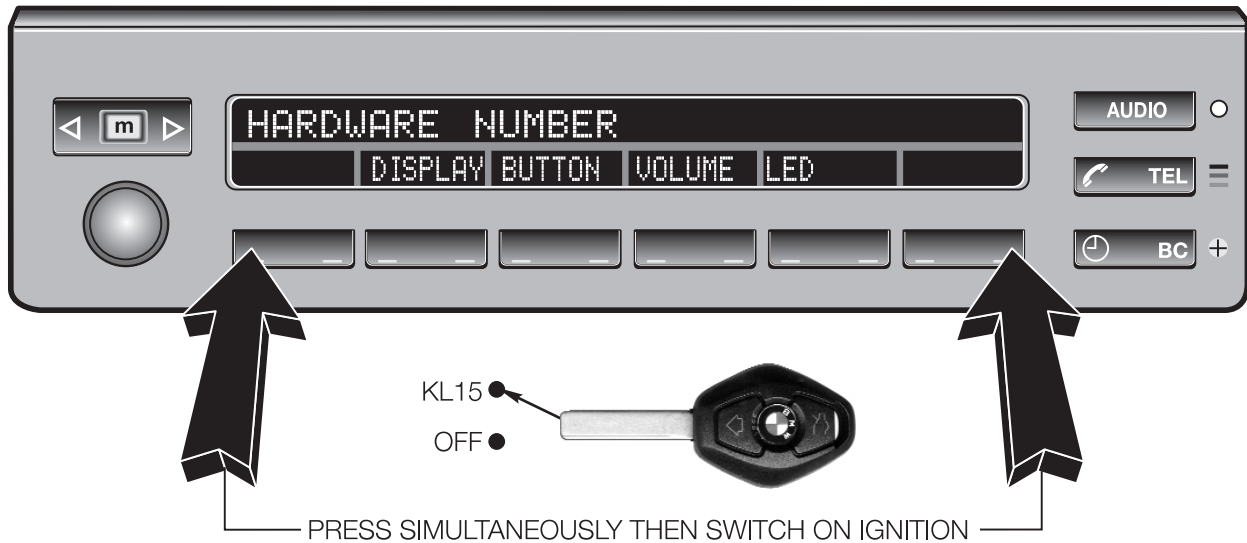

UNIT IDENTIFICATION - The following information appears for approximately 3 seconds when the ignition is switched on

- Hardware number
- Software number
- Variant index

All other test must be started within three seconds, while the identification data is displayed. If not the MID will exit the test mode.

DISPLAY TEST - Activate this test by pressing the display menu button. All elements of the main and menu displays are illuminated with different check patterns.

BUTTON TEST - Start this test by pressing the button test menu button. All buttons on the MID have been assigned an alphabetical letter that will appear when the button is pressed.

VOLUME CONTROL TEST - This test is carried out by pressing the volume menu button and turning the volume knob. Numbers from 01 to 36 appear in the display indicating each step of the knob's rotation.

STATUS LED TEST - Activate this test by pressing the menu button. All status LEDs are illuminated.

MID REMOVAL PROCEDURE

The X5 MID is removed from the center console as follows:

1. Pull the volume knob off the MID.
2. Insert a T10 torx wrench into the recessed hole beneath the volume knob shaft.
3. Turn the wrench 90° to the left until a stop is felt.
4. While maintaining tension on the wrench in the stopped position, use the torx wrench as a pull handle to pull the left side of the MID out of the center console. The right side of the MID acts as a hinge on the center console.

The radio/tape player is removed by turning the 2.5mm allen head bolts to unlatch it from the center console as on previous radios. The radio allen head bolts are visible once the MID is removed.

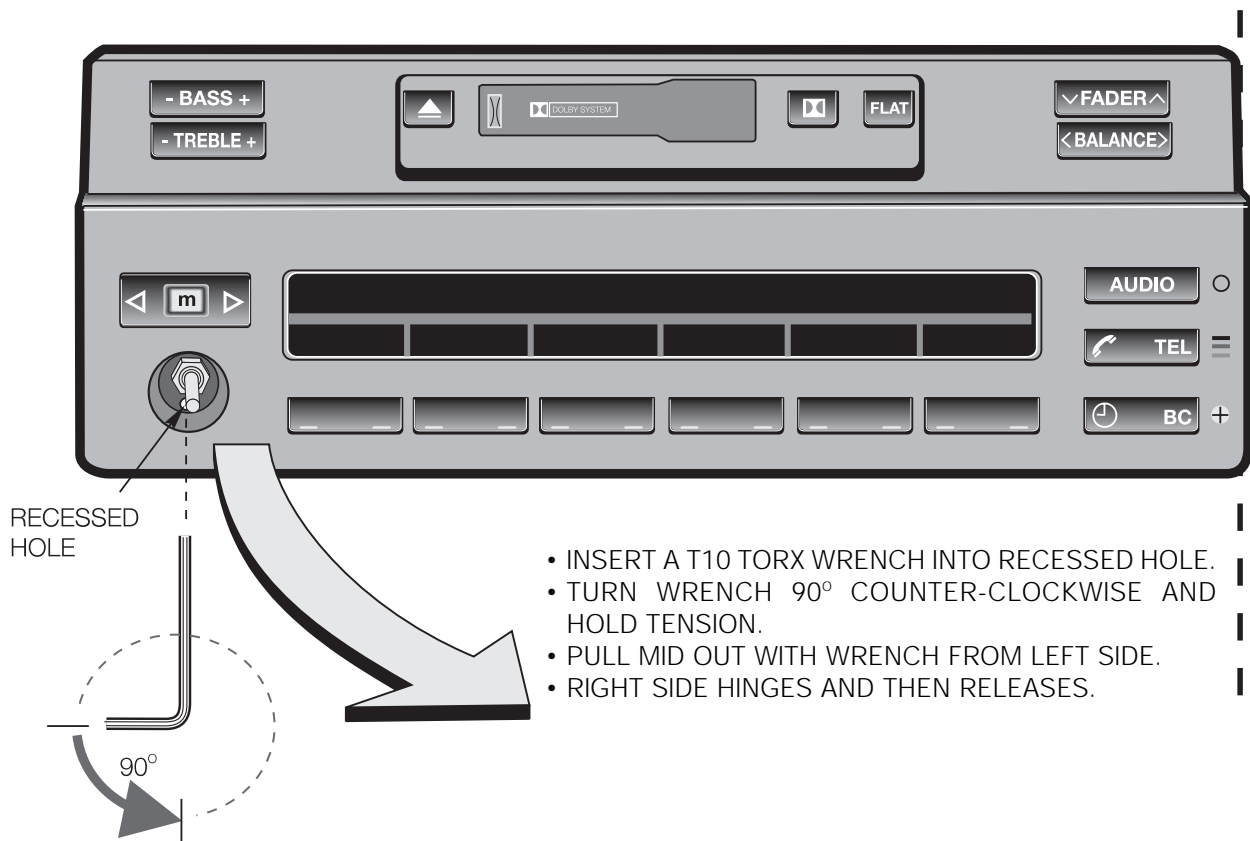

ON BOARD COMPUTER (High Version)

The familiar BC V on board computer functions are carried over to the X5. The BC processing is a function of the IKE and can be displayed in the cluster matrix and the MID or if Nav system equipped, on the BMBT LCD screen.

The following BC functions are available for display:

- Time/Date
- Distance
- Limit
- Arrival Time
- Stop Watch
- Average Speed
- Range
- Average fuel consumption
- Two Timers for programming parked car ventilation



Operation and programming of the BC is carried out with the MID as on the E38.

The menu displays change as each function is called up for programming/resetting purposes. this includes the changeover functions for the clock, mileage and MPG displays.

BC functions can be displayed in the cluster matrix by pressing the turn signal lever as in the past.

The cluster displays can be programmed for number of displays and order of appearance.

ON BOARD COMPUTER (Base Version)

The On Board computer information on the base variant cluster can only be displayed in the center matrix. The following information can be displayed:

- **OUTSIDE TEMPERATURE**

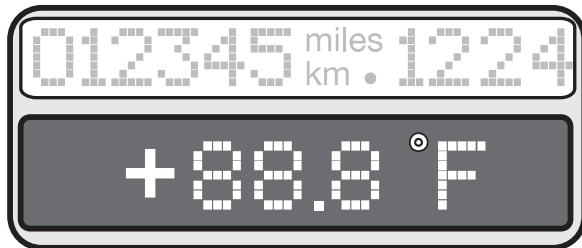

- **FUEL CONSUMPTION**

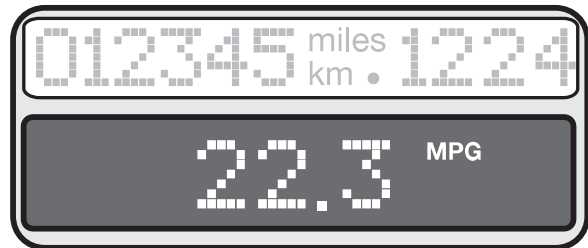

- **AVERAGE SPEED**



- **ESTIMATED DRIVING RANGE ON REMAINING FUEL**



62530008

When KL R is switched ON, the outside temperature will be displayed. To call up any other function, the turn signal lever must be pressed and released. The other functions are than displayed one after the other. A blank field is provided after the average speed display to allow the driver to switch off the display.

A freeze warning is incorporated in the BC. If the temperature drops below 37°F, the gong will sound and the temperature display will flash in the BC. Pressing the turn signal lever will cancel the display.

The temperature display in the base on board computer can be switched from Fahrenheit to Celsius by pressing the instrument cluster button and holding it while cycling the ignition key. During this procedure, the base instrument cluster also produces a "temperature changeover signal" on the K-bus for the IHKA to switch over the control panel/module to match the display in the instrument cluster. This feature is only available with the base instrument cluster.

Two of the displays "Average Fuel Consumption" and "Average Speed" can be reset to start new calculations. To reset the displays, press and hold the turn signal lever, for longer than one second, when the function is called up. The BC will than start to compute a new aver-

BC TEST FUNCTIONS (High Version)

The BC test functions can be used to check various inputs, outputs, status and functions of the IKE. It follows the BC test functions of the E38 with the test functions being displayed in the cluster matrix. (Reference the IKE handout of the E38 Introduction course).

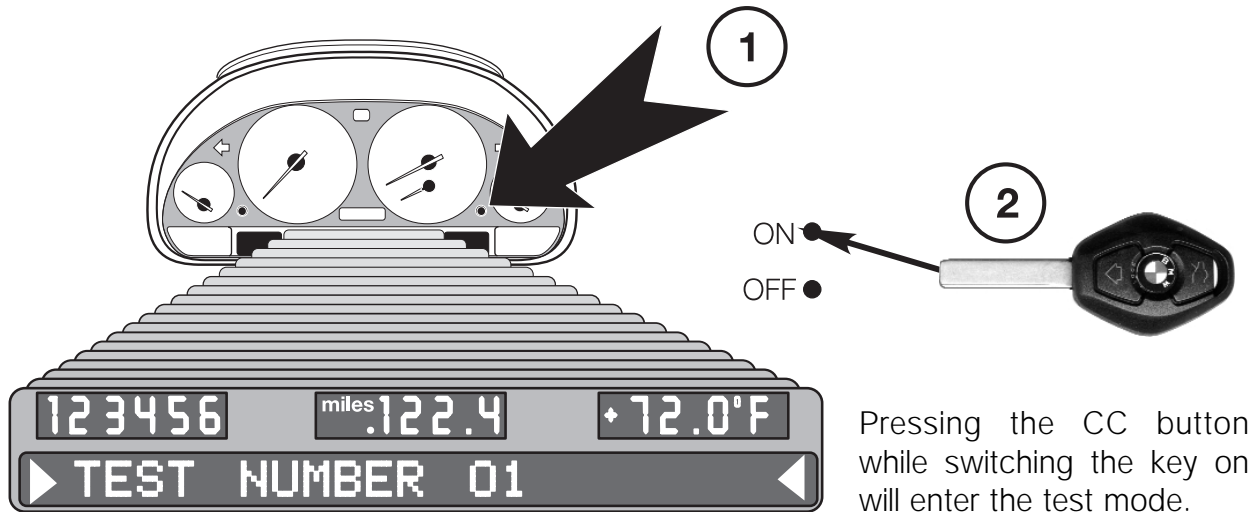

Pressing the CC button while switching the key on will enter the test mode.

Test # 1,#2 are the only unlocked tests of the test functions. Test #19 is used to unlock the tests as follows:

1. Go to test #1 and display the VIN.
2. Add the last five digits of the VIN and note the total, **EG**; VIN = BG00222. $2+2+2 = 6$.
3. Go to test #19. Display reads "Lock ON".
4. Press the reset button "6" times.
5. Press the CC button. The tests are now unlocked.

Several test functions have sub-test values that are called up by pressing the reset button while the test is displayed. The test functions available on the BC include:

- | | |
|--|---|
| TEST 01 - Vehicle specific data | TEST 12 - Data for est. arrival time |
| TEST 02 - Cluster self test | TEST 13 - GONG Test |
| TEST 03 - SI data | TEST 14 - HEX value for fault memory |
| TEST 04 - Fuel Consumption | TEST 15 - Port binary input values |
| TEST 05 - Range calculation data | TEST 16 - OEL Temp |
| TEST 06 - Fuel tank sensor inputs | TEST 17 - RCC-EMPF.: _ _ _ _ MIN. |
| TEST 07 - Coolant/RPM inputs | TEST 18 - BLANK |
| TEST 08 - Road speed input | TEST 19 - Lock/Unlock |
| TEST 09 - Battery Voltage | TEST 20 - Correction Factor |
| TEST 10 - Country Code | TEST 21 - Reset function |
| TEST 11 - Unit Code | |

BASE BC/INSTRUMENT CLUSTER TEST FUNCTIONS

In addition to the fault memory and diagnostic link, the base instrument cluster contains a series of test functions that can be accessed to check various functions and values. The test functions are displayed in the mileage LCD block. There are a total of 21 test functions. The test functions are similar to those of previous Board computers and contain similar tests.

- Tests 1 & 2 are always unlocked.
- Tests 3 -21 are only accessible after unlocking the test function. Test 19 is the unlock function for accessing the displays.

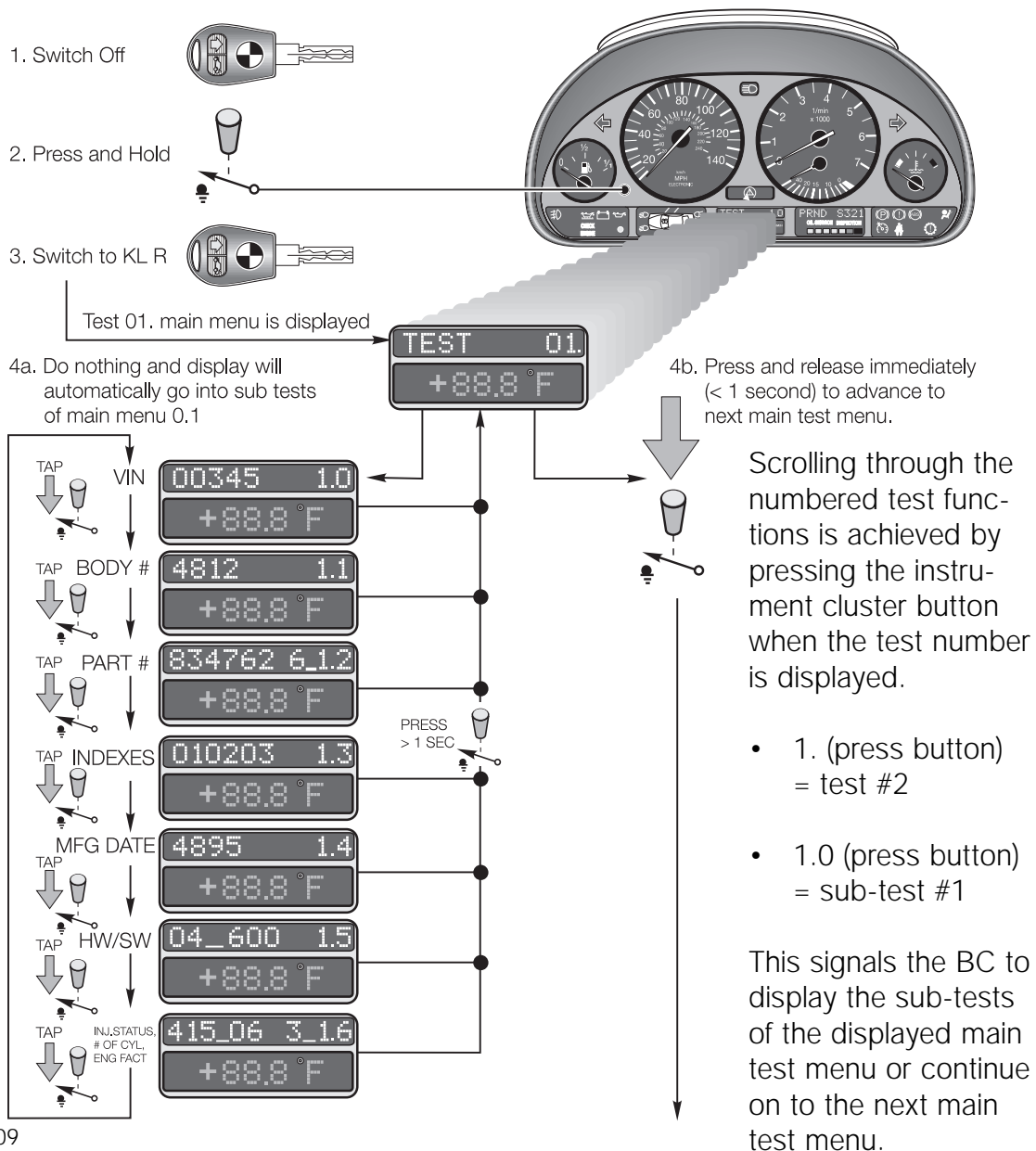

TEST 19. - LOCK/UNLOCK

Sub-Tests

L-ON...

L-OFF 19.0 =

Display changes from "L-ON" to "L-OFF" every second. To unlock test functions, press the cluster button **immediately** when it changes to "L-OFF".

Tests are automatically locked when exiting test functions.

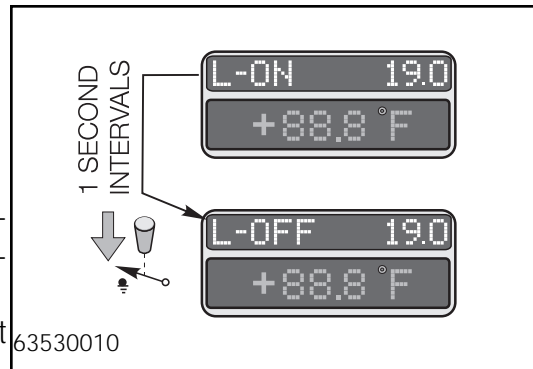

The test functions of both cluster/BC systems are the same except where noted

TEST NO. 01

The IKE/Cluster module supplies the following data, which appears on the cluster matrix display:

Sub test base version

- 1.0 • Vehicle Identification number = FGSTNR: GB111111
- 1.1 • K value = K: 4739 (high version) - Body Number (low version)
- 6_1.2 • BMW part number: Bmwtrn. 13809873
- 1.3 • Encoding, diagnosis and bus index: Cl: 01 Di: 01 bi:01
- 1.4 • Production date: dat: 52/94
- 1.5 • HW/SW number: hw: 40sw:80
- 3_1.6 • Injection Status/number of cylinders/engine factor
 - Motor: zyl:8
m:6 s:400
 - ROM Date: ROM; 23.08.96 (high version)

TEST NO. 02

The following displays and instruments are activated (system test):

- Speedometer, tachometer, coolant temp gauge, fuel gauge.
- LC displays (segment test)
- Indicators and Warning Lights

This test can only be called up with the vehicle at a standstill, engine turned off, with KL R or 15 switched on.

TEST NO. 03

The following SI data can be displayed:

Sub Test base version

- 3.0 • Liters
- 3.2 • Periodic inspection - not for US
 - SI km since last reset: si km: 1250
 - SI automatic transmission kilometers: SI-GETR - km 23300

TEST NO. 04

Momentary Fuel Consumption is displayed:

Sub Test base version

- 4.0 • VBR: 0.0 L100km
- 4.1 • VBR: 0.0 l/h

TEST NO .05

This function shows the range calculation data:

Sub Test

base version

- 5.0 • Range at measured fuel consumption: RW-vbr: 19.5 l/100 km
- 5.1 • Momentary distance to go (km)

TEST NO .06

In this function, the fuel tank volume for the right and left half of the fuel tank and the current total tank volume are shown in the Instrument Cluster matrix display.

This enables the function of the float level sensors to be checked.

Display: tnk 29.5/34.2/63.7L
 TNKANZ 60.2L PHASE 1

The first numerical value in line 1 shows the contents of the left half of the fuel tank, the second, the volume of the right half of the tank. The third value is the current total value. If a level sensor is defective, its value reverts to 0.

Line 2 shows the current average value (displayed value) for the contents of the fuel tank. The numerical value after the word phase refers to the valid computed number.

Phase 1: Regular computing method by way of sensors (both sensors OK).

Phase 2: Calculation in progress from TKVA signal (sensor faulted)

Phase 3: Fuel tank contents cannot be computed, fuel gauge reads 0 (at least one sensor is faulted).

Sub Test

base version

- 6.0 • Fuel Level averaged
- 6.1 • Total tank Level Averaged
- 1_6.2 • Indicated value and tank phase
 - 1 = both sensors OK
 - 2 = one sensor fault
 - 3 = implausible input

TEST NO. 07

Sub Test

base version

- 7.0 • Coolant temperature. ktmp: 076⁰ C (high version)
- 7.1 • Outside Temperature
- 7.3 • Engine speed: N:5238 u/min (high version)
- 7.4 • Vehicle Speed

TEST NO. 08

- Momentary Road Speed V: 085 KM/H (high version)

Sub Test

base version

- 8.0 • HEX Code - Cluster inputs

TEST NO. 09

Sub Test

base version

- 9.0 • Battery voltage (terminal 30) Ub: 12.5 v

TEST NO. 10

Preset national market codes list. The number is encoded in the IKE/Ckuster module with the central code key

Sub Test

base version

- 10.0 • Display: usa 02

TEST NO 11

The unit code is entered in the EEPROM by the DIS after IKE has been installed and can be read out by means of test function 11.

Sub Test

base version

- 11.0 • Cluster Code

TEST NO. 12

This test function shows the data for computing the vehicle's estimated time of arrival.

- Average speed for calculating arrival time: vank: 029.7 km/h
- Current arrival time: ank: 13.04

Base version - not used

TEST NO. 13

This test function enables the gong to be tested, Display: gong?

- After confirming by pressing the trip odometer reset button, the four audible warning signals are triggered off once in succession.
- Gong T1 (Memo signal) 2.0s
- Gong T2 (Outside temperature) 1.5 s.
- Gongs T1 and T2 (LIMIT/CODE warning) 1.5 s
- Gong T3 (Check Control Gong)

Sub Test

base version

- 13.0 • Activate gong by pressing button

TEST NO. 14

This function shows the contents of the fault memory in a hexadecimal code.

Display: DIAG: D7 81 033

TEST NO. 15 - 18

Not assigned to any test function.

TEST NO. 19

Procedure for unlocking the BC test functions.

TEST NO. 20

BC consumption value correction factor. This test adjusts the correction factor for the consumption value displayed in the MID. The production line installed value is 1000. The value ranges from 750 to 1250.

To adjust the correction factor press the trip meter reset button once for a reduction of 1. For each press of the reset button the value decreases by 1 until it reaches 750. After 750 the number will reset to 1250 and begin to count down again.

To accept the set correction factor press the CC button.

The consumption correction factor (VK) is calculated from the actual amount of consumed fuel (VBR IST) and the displayed value (VBR ANZ):

$$VK = (\text{Actual MPG} / \text{Displayed MPG}) \times 1000.$$

Sub Test base version

- 20.0 • "ones" digit correction
- 20.1 • "tens" digit correction
- 20.2 • "hundreds" digit correction

TEST NO. 21:

This function resets the software at the IKE. This reset is necessary after replacing for example one of the fuel tank level sensors. Otherwise the damping function in the software will prevent the actual value from being shown only after a long time duration.

Display: reset ?

If the test is terminated without a software reset, the ignition switch must be turned back to "0" or the CC button pressed.

Sub Test base version

- 21.0 • Reset software

HEATED STEERING WHEEL

The heated steering wheel system consists of the following components:

- A heating filament integrated into the steering wheel cover.
- An NTC temperature sensor, in the filament circuit, to regulate the heating current.
- A push button mounted in the right side MFL key pad.
- The control module located behind the air bag assembly.
- Slip ring assembly for the power and ground supply.

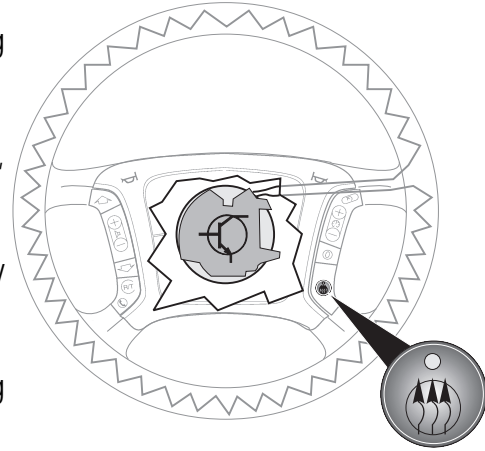

OPERATION

When KL 15 is switched ON, the heated wheel can be switched ON by pressing the button. A green LED illuminates to indicate system operation. Maximum current is supplied and heats the filament to its operating temperature (surface temperature of approximately 90°F). The NTC detects the temperature of the filament and causes the control module to cycle once the wheel is heated. Cycling is carried out with a pulse width modulated signal.

The system is not connected to the diagnostic link, however the control module does monitor operation of the system. If a fault occurs during operation, the system and green LED will switch OFF.

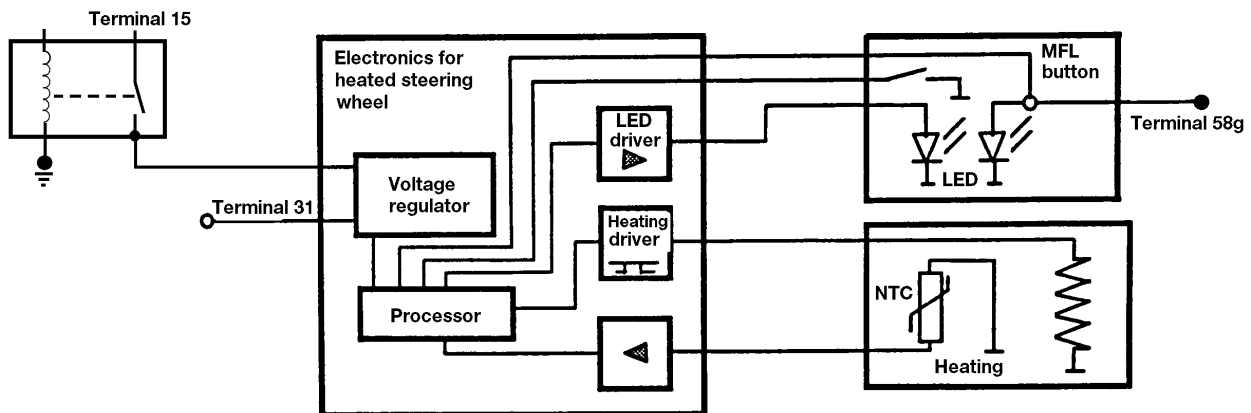

AUDIO SYSTEM

The X5 Audio system consists of:

- **Radio/Tape player** - houses radio electronics, tape player, treble, bass, fader, balance adjustments.

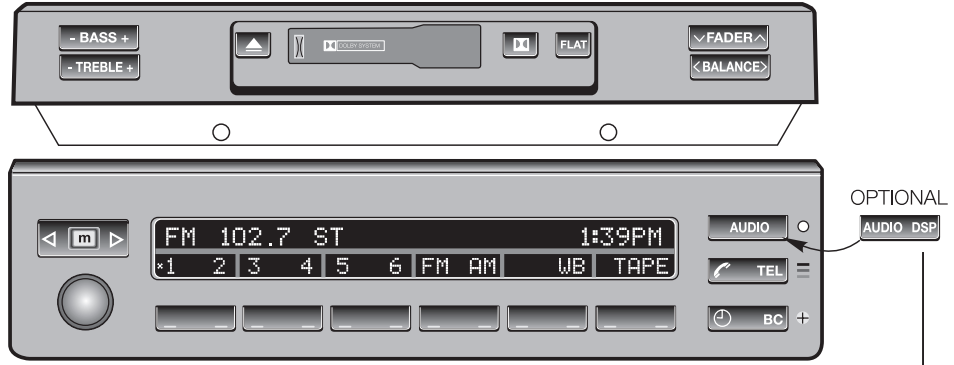

- **MID** - for ON/OFF, volume control, station selection, digital sound processor (DSP) control, etc. If the DSP system is installed, the audio button in the MID has a second position to activate the controls.

The memory feature of the X5 DSP has two memory positions.

- **Amplifier** - Mounted in the left rear.
 - The standard 200 watt amplifier for the 10 speaker non DSP audio system
 - The optional 12 speaker 440 watt amplifier for the 12 speaker DSP audio system.
- **CD Player** - mounted in left rear if installed.

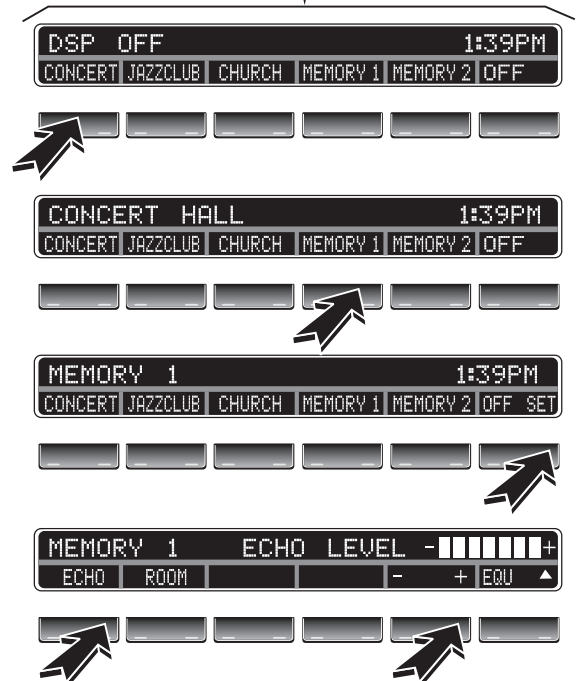

MFL Controls

RADIO TEST FUNCTION: To activate the test switch the radio on and within 8 seconds press and hold the "m" button for more than 8 seconds. The displayed tests include:

- Radio Serial Number
- Radio Production date
- DSP Recognition (1/0)
- Station signal Strength
- Road speed dependent volume control (GAL 1-4)
- Area Use Control - ECE, US, Canada selections
- AF - Manual or Off (Audio freq.)
- TP-V (Traffic Program Volume)

Adjusting the GAL makes the volume increase more noticeable (4) or less noticeable (1).

MARK II NAVIGATION SYSTEM

COMPONENT OVERVIEW

The X5 Mark II Navigation System is similar to E38/E39 Mark II. All of the E38/E39 Mark II system components are carried over with the exception of the BMBT:

X5 Specific Board Monitor (BMBT):

- 5 inch display (320 X 234 pixel resolution)
- Uses on screen soft keys for telephone send/end functions. E38/E39 uses buttons.
- Control of auxiliary ventilation function
- Provides display and control functions for the Audio System (radio, cassette and CD).
- Provides display and control functions for systems in the menu display.

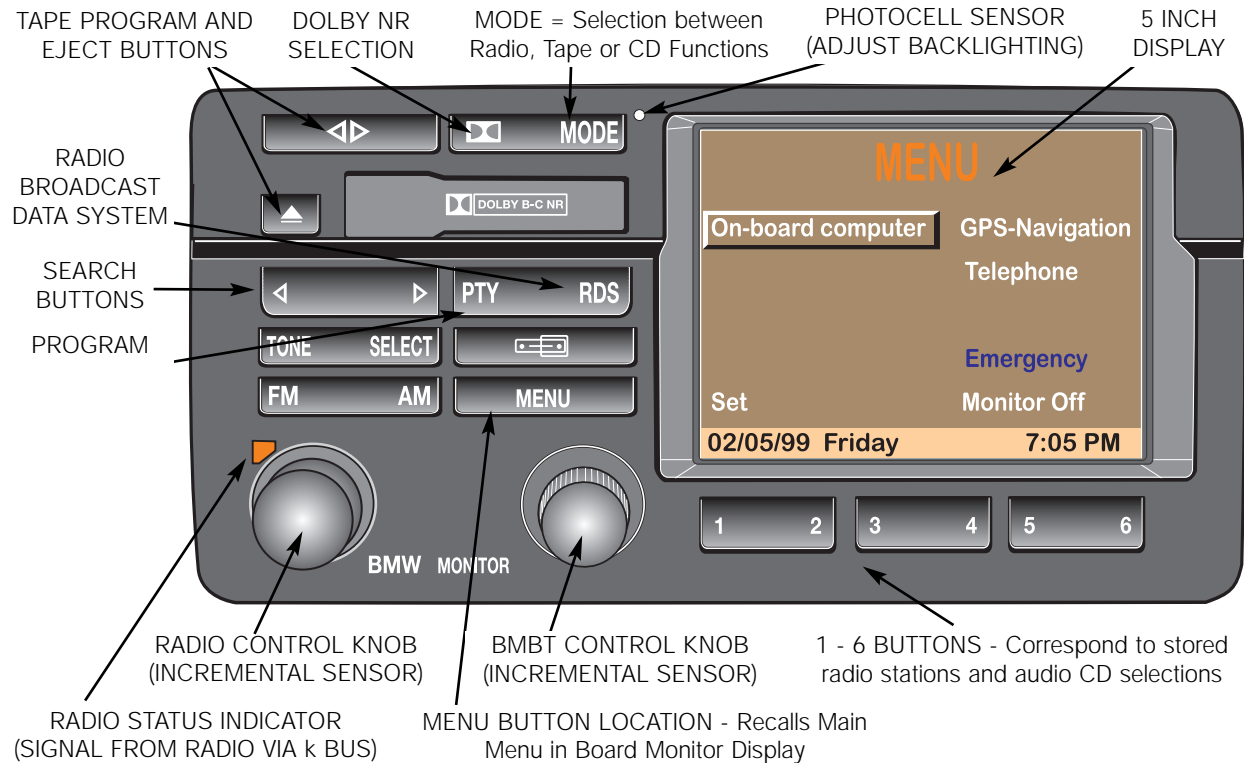

- **RDS** = Radio Broadcast Data System. In the future, this feature will provide a wide variety of commercial broadcast data as well as traffic and limited weather information as a text display in the radio or Board Monitor display.
- **PTY** = The RDS system also includes the PTY feature which stands for "Program Type". PTY indicates the type of music being broadcast. This is helpful for organizing favorite station programming. Complete RDS functionality requires a cooperative effort on the part of the radio stations to provide this service. There are approximately 700 FM Radio Stations in the United States currently transmitting messages via RDS.

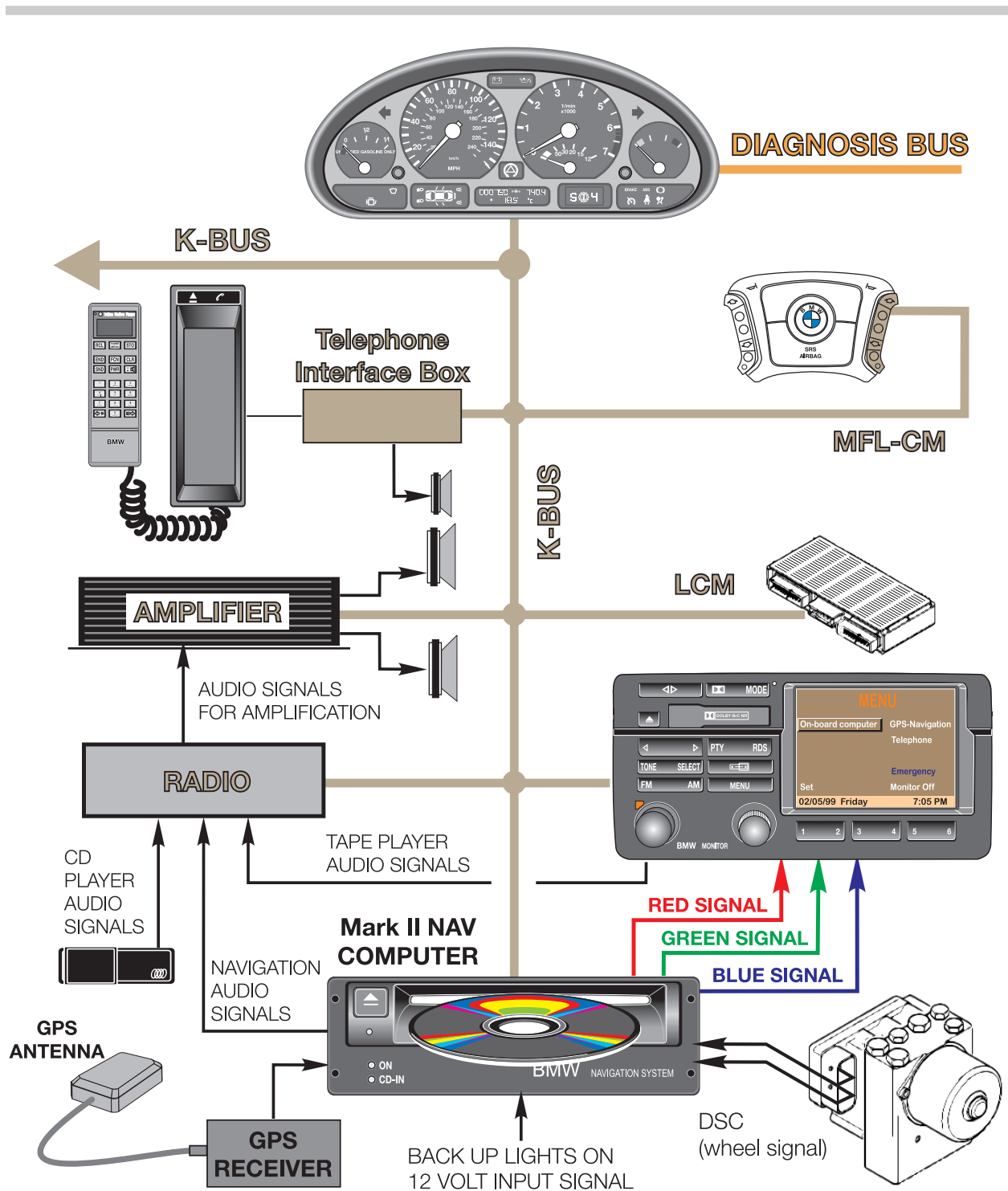

The BMBT communicates with interfacing control modules via the I Bus. As with all previous Original Equipment Navigation Systems, the radio electronics are installed in the trunk. The BMBT sends and receives operation instructions to the radio via bus communication. The Mark II Nav computer continues to provide the RGB output signals to the BMBT for system function display.

X5 BOARD MONITOR & NAVIGATION SERVICE MODE DISPLAYS

The Mark II system provides a service mode display function. These screens provide system hardware/software identification numbers and status of Board Monitor and Navigation specific functions for use as a diagnostic tool. The screens are accessed as follows:

- From the Main Menu select "Set".
- Once in the Set function, press and hold the menu button for 8 seconds.
- The next screen to appear is the SERVICE MODE menu.

The first accessible function is "On-board monitor". Pressing this selection calls up the version screen which provides identification of hardware/ software specific index versions for the installed system.

Pressing the functions key at the bottom continues into additional screens including the Key Functions and Brightness controls.

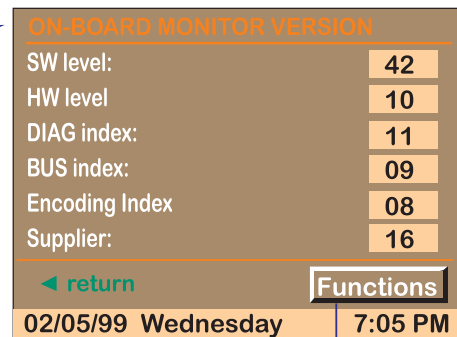
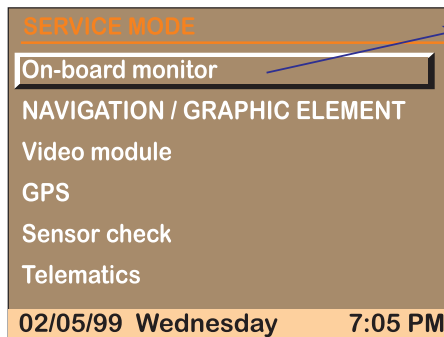

Key Functions tests the key input on the BMBT. Input status (1-25) will display in the window.

If no keys are pressed the status will be displayed as "FF".

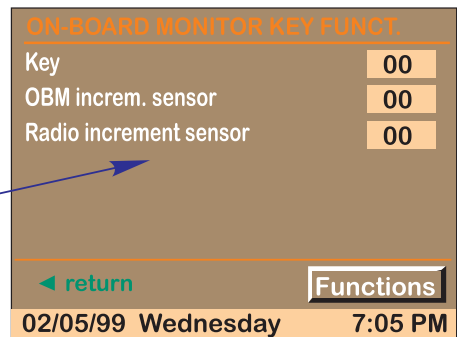
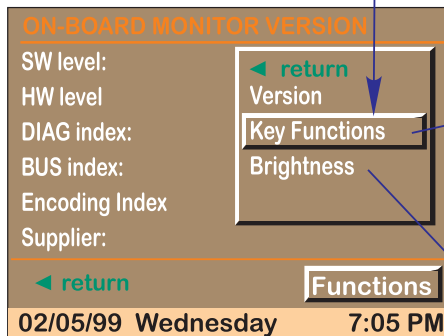

Rotating the left or right rotary knob displays hex code input status.

Rotated slowly, the display changes with each increment. The display eventually stops at "1F" in the left rotated direction and "E0" to the right.

The key function test terminates automatically if no keys or knobs are moved after a short duration ("00").

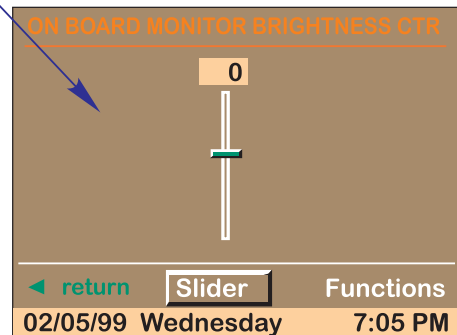

The next accessible function is the NAVI/GRAPHIC ELEMENT.

This screen identifies hardware/ software specific index versions for the installed system.

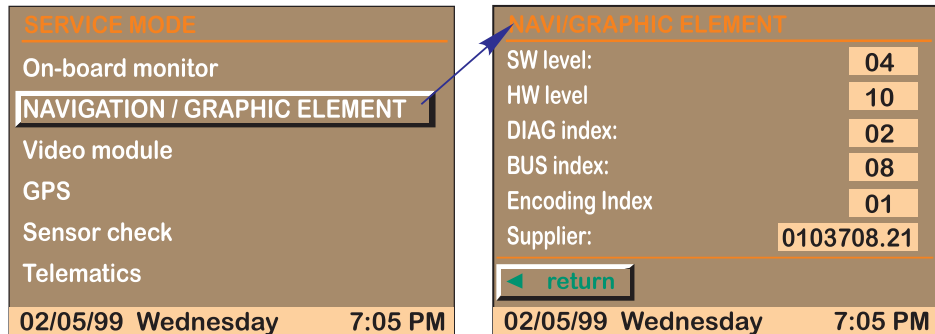

The Video module selection is not functional since the US version Mark II nav system does not utilize the video module.

The next available selection from the service mode menu is "GPS".

This display provides the GPS receiver module hardware version number and date of programmed software.

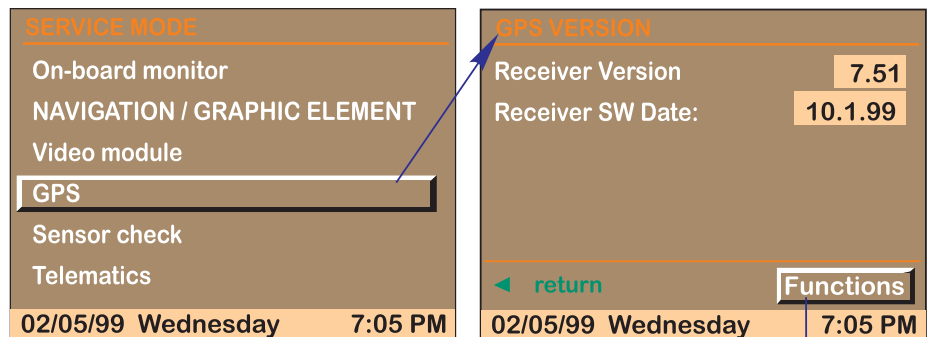

Pressing the functions button in the lower right corner of this screen provides a sub-selection menu.

GPS Status provides information on the exact coordinates of the vehicle based on the calculations of the GPS receiver module.

GPS Tracking provides information about the individual satellites currently sending signals to the GPS receiver module. Though interesting, this display provides data which is not usable for BMW service

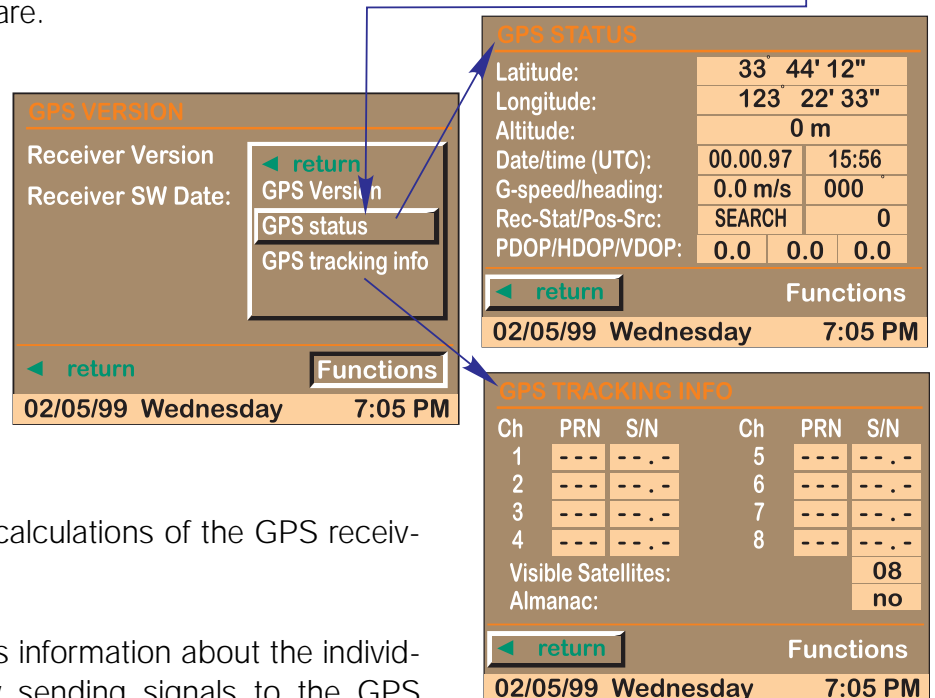

The next selection available from the SERVICE MODE menu is "Sensor check" which provides:

- Wheel speed input (only one wheel speed signal, displayed).
- Number of satellites detected.

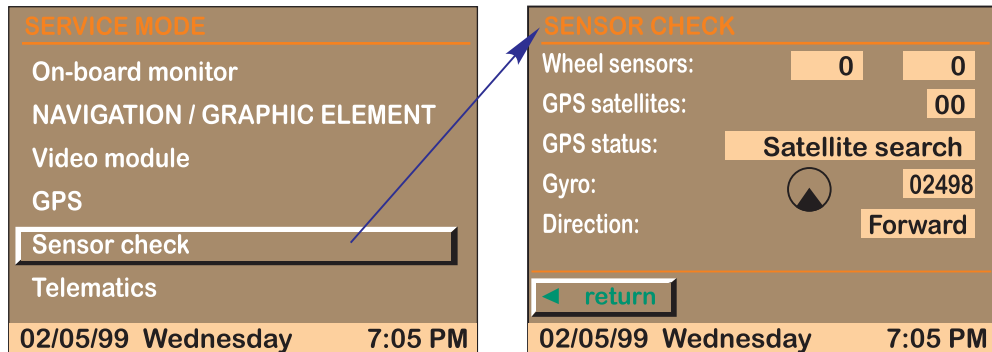

- What mode the GPS receiver module is currently in; (ie: Search)
- The Gyro status provides the millivoltage value the Nav computer is utilizing for the current vehicle position. This area also includes an icon representing what direction the vehicle is heading in.
- The direction status indicates what gear is selected (forward or reverse).

The Sensor check display is intended to be used while test driving the vehicle. Use the legend below to compare with the display status.

STATUS DISPLAY	WHAT SHOULD BE DISPLAYED	WHAT TO DO IF NOT OK
Wheel Sensors:	As the vehicle is driven, the number should increase with an increase in vehicle speed.	Check fault codes in ASC/DSC system. If necessary carry out wheel speed sensor test.
GPS Satellites:	With unobstructed upward view of sky the display should be > 3	Check for interference of signals to GPS antenna, Check integrity of circuit from GPS receiver module and Nav computer
GPS Status:	"See Legend on next page"	
Gyro:	Direction icon moves with vehicle turning movement. Milli voltage display value should be approx 2500 mV (+/- 400mV) when the vehicle is stationary or driven straight ahead. When the vehicle is turning, the value must rise or fall which indicates the gyro sensor is detecting yaw.	Replace Navigation computer.
Direction:	Reverse is displayed when range selector is in reverse. Forward in any other range.	Check back up light signal input.

GPS Status Text Display	Description
1. "GPS fault"	Problem with GPS system. Swap GPS receiver module and or antenna from know good vehicle after checking GPS status display information described on page 153 .
2. "Reception Interference"	Problem with GPS system. Same as above.
3. "No Almanac"	No Data yet stored from satellites. The GPS almanac is a memory account of received satellite signals. If the vehicle battery has been disconnected or after replacing a GPS receiver module it has an empty memory and requires satellite signals to become functional. After the receiver module receives battery voltage and ground, it must be left outside with an unobstructed sky above with the ignition switched to KL R for approximatly 15 minutes.
4. "Satellite search"	GPS is currently searching for satellite signals.
5. "Satellite contact"	At least one satellite is found
6. "Position known"	Vehicle's Latitude and Longitude known. Navigation is possible.

The last selection available is the **Telematics** entry display. This replaces the "VIN" selection from the E38/E39 Mark II systems. The only requirement of this entry screen is that the VIN is entered at the VPC when prepped prior to distribution.

This is necessary for the Emergency program if needed when calling the Cross Country Group Roadside Assistance Program.

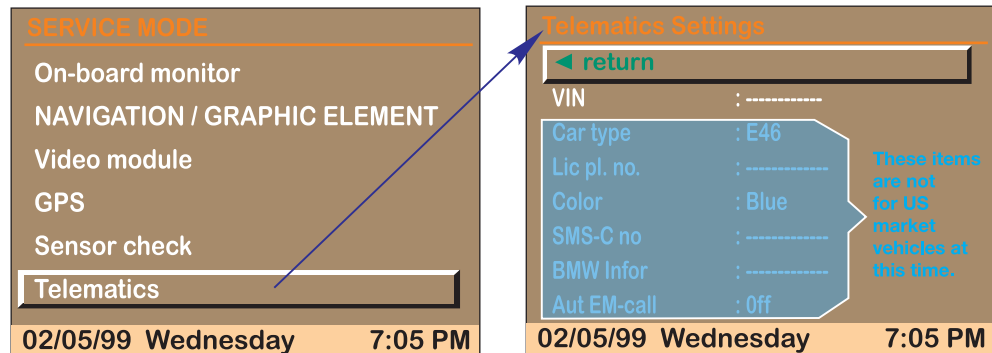

Additionally, if the vehicle is equipped with a Phase V phone the system will automatically utilize the entered VIN as per E38/E39 Mark II systems.

The VIN is entered at the VPC for all vehicles (with or without a Phase V phone). If the VIN has been incorrectly entered it can be changed by turning and pressing the rotary knob when the correct letter or digit of the last seven character of the VIN is displayed.

The balance of the data displayed below the VIN entry is not currently used in the
