Table of Contents

Integrated Service Information Server

Subject	Page
Introduction	3
ISIS Rack Cabinet	5
ISIS Ventilated Rack Cabinet	5
ISIS Rack Cabinet Storage Area	5
ISIS Rack Cabinet Security	5
ISIS Rack Cabinet Cooling	5
ISIS Servers Units	6
Technical Specifications	6
Front View of ISIS Servers Units	7
Indicators on the Hard Drives	10
CD-ROM/DVD-ROM Indicator	10
Hard Disk Drive Indicators	10
The Rear View of the ISIS Server	12
Ports and Connectors	12
LocalView LCD Display	15
Uninterrupted Power Supply (UPS)	16
“MGE Pulsar M 3000” UPS - (USV in German)	16
UPS Battery Module	16
UPS Bridge Time	16
Operating and Display Elements of the UPS	17
The Rear View	17
LAN Communication Interface	18
The Front Control Panel	19
Hot Swap Maintenance Bypass Module	20
HP ProCurve LAN Switch 1800-24	21
Front View	21
LEDs	22
Cabling	23
Internal ISIS Rack Cabinet Cabling	23
ISIS Ventilated Rack Cabinet Wiring Diagram	24

Integrated Service Information Server (ISIS)

Model: All

Production: 02/2008

OBJECTIVES

After completion of this module you will be able to:

- Demonstrate the concepts of the ISIS server and its related components
- Demonstrate the operation of the ISIS server in a workshop environment
- Demonstrate preventive maintenance on ISIS components, as required

Introduction

The Integrated Service Information Server (ISIS) is the intelligent server system for the workshop of the future. This integration server platform is designed to further improve service department/workshop performance. The generation of diagnostic and programming systems, available with ISID, ICOM, ISAP and IMIB is based on the ISIS server platform concept. A new generation of service applications and software, based on the ISPI platform is utilized. This ISPI service application and software suite consist of ISTA, ETK, and KSD.



The ISIS system consists of the following hardware components:

- Rack cabinet (ventilated)
- Two Fujitsu Siemens PRIMERGY servers RX300 S3
- MGE Pulsar M3000 UPS with a Hot Swap Maintenance By Pass Module
- HP ProCurve 1800-24G LAN switch
- Device shelf to support two Software Service Stations (SSS) that are already present in the workshop
- Cabling



Index	Explanation
1	GigaBit LAN switch 24 port (installed in the rack on delivery)
2	SSS PCs
3	Device shelf for SSS PCs
4	2 x dummy plate 2HE
5	2x PRIMERGY RX300 S3 server
6	UPS 3000 VA MGE
7	MBP unit: Installation of the socket strip from the rear of this position

ISIS Rack Cabinet

The rack cabinet is supplied to the US market in one configuration: "Ventilated".

A 19 inch standard network rack mount has been utilized by some centers. The network room for this type of rack mount must be air conditioned and meet the 50 to 77 degrees Fahrenheit temperature requirement. The room must be secured by a lockable door. This also applies to a network room for an ISIS rack cabinet.

ISIS Ventilated Rack Cabinet

The ventilated rack cabinet contains the two ISIS servers, capacity to house two SSS units, a UPS unit with MPS, and a HP LAN switch. The ventilated rack cabinet weighs approximately 700 lbs and occupies a space of 48 cubic feet. The main structure/housing is a sealed four post aluminum frame which includes a cross-flow ventilation and filtration system.

ISIS Rack Cabinet Storage Area

The ventilated rack cabinet must have a clear, clean area around its perimeter. A distance between the front and back of the ISIS rack cabinet must be at least 36 inches and a distance on both sides of 12 inches should be maintained.

Note: In areas with greater space restrictions a minimum of 36 inches must be maintained behind the cabinet.

ISIS Rack Cabinet Security

Security of the ISIS rack cabinet is maintained by a key lock mounted on the front and rear doors handles. Both side panels of the ISIS rack cabinet are also key locked. Two keys per door and per side panels are supplied at time of installation.

ISIS Rack Cabinet Cooling

The ISIS rack cabinet has an air filter mat mounted in its base with two cooling exhaust fans (225 CFM) mounted on the rear door. Cooling air is drawn in from the bottom of the ISIS rack cabinet across a cleanable/replaceable air filter mat. The cleaned air is allowed to flow in and around the two ISIS servers, two SSS units, UPS unit with MPS, and a HP LAN switch. The cooling air is exhausted out the two rear door mounted fans.

Note: Cooled clean air must be allowed to flow thru the ISIS rack cabinet. All doors must be fully closed and locked. Doors should not be left open. Please check for door shipping blocks that might not have been removed during installation. These door shipping blocks are attached by red duct tape to the lower corner of the door on the opening side on both doors. These door shipping blocks must be removed and discarded.

ISIS Servers Units



The two “Fujitsu Siemens RX300 S3” rack server units are the core elements of the ISIS computer system.

Technical Specifications

- Two “INTEL XEON” Quad-Core microprocessors are used per server. These Quad-Core processors are based on the Intel Bensley platform with Intel Clovertown processors technology. (4 processor cores per 2 physical processors in one server) A total of 16 processors cores are used in the twin ISIS server system. Processor speed is 2.66 GHz with a Front Side Bus (FSB) of 1,333 MHz.
- 8 GB main memory (FB-DIMM technology) is used in each server.
- A six port SAS controller with RAID 5 and 256 MB battery-buffered cache.
- Three 300 GB hot-plugged hard drives with 600 GB useable capacity.
- Three additional hard drive slots are available for future expansion.
- Dual Gbit/s Ethernet controller on board.
- CD/DVD slim line drive technology.
- Integrated LCD display for error and status messages. (LocalView Display)
- Hot-plug PCIe expansion slots are available.
- 8 Hot-plug and redundant cooling fans are used. (4 fans plus 4 redundant cooling fans per server.)
- Two power supplies are used in each server.

Having two rack servers in one system is for redundancy and backup. If one server fails, the other can take its place to prevent an interruption or downtime of the workshop systems and personnel.

Front View of ISIS Servers Units

Operating Elements

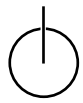

ON/OFF button

When the system is switched OFF, it can be switched ON again by pressing the ON/OFF button. When the system is operating, pressing the ON/OFF button will switch OFF the system.



The ON/OFF system does not disconnect the server from the mains. To disconnect the mains completely, remove the power plug(s).

NMI NMI button



Please do not press! The NMI button may only be used by Service.

RST Reset button

Pressing the reset button reboots the system.

ID Identification (ID) button

The ID indicators on the front and rear of the server light up (blue) when the ID button is pressed. The two ID indicators are synchronized.

Front : Display and control elements

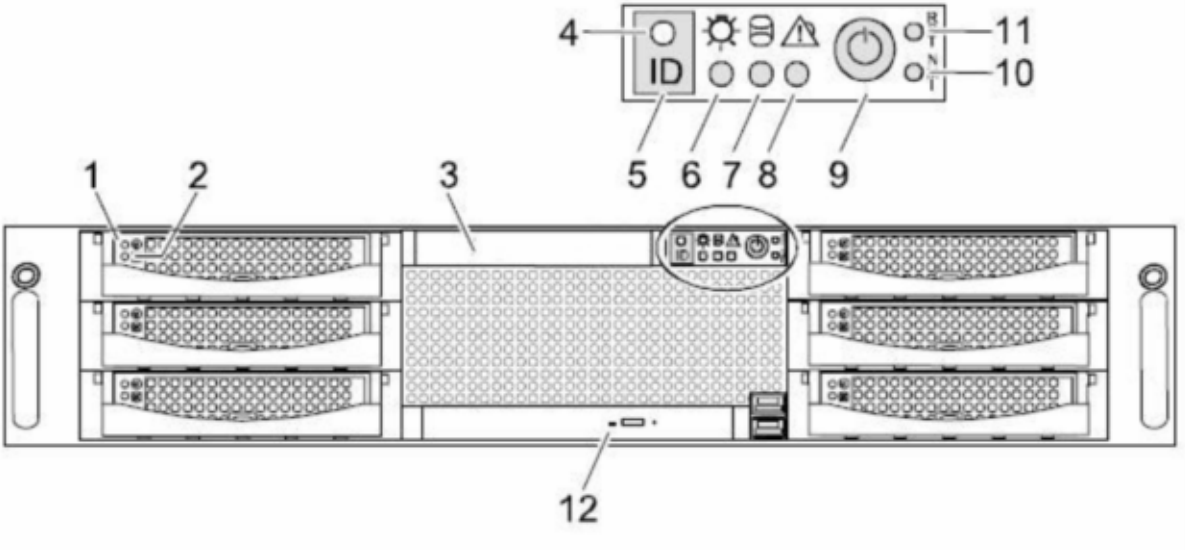

Index	Explanation	Index	Explanation
1	HDD BUSY indicator	7	Drive access indicator
2	HDD FAULT indicator	8	Global error indicator
3	LocalView display	9	On/off switch
4	ID indicator	10	NMI button
5	ID button	11	Reset button
6	Operating indicator	12	CD-ROM/DVD-ROM indicator

Indicators on the control box



Operating indicator (two-color)

Lights up orange when the server is switched off, but power supply voltage is on (standby mode).

Lights up green when the server is switched on.



Drive access indicator (green)

Lights up green when an internal SAS drive (HDD) is accessed.



Global error display (orange)

Does not light up when the system is OK. No service case or critical event has occurred.

Lights up orange when a likely fault has been detected. Precise details can be queried in the system and event log.

Flashes orange when a critical event has occurred.

Precise details of the event can be queried in the BIOS setup, the system and event log. After a power failure, the indicator is activated after the restart if the event is still accurate.

ID ID indicator (blue)

Lights up when the system has been selected by pressing the ID button. Pressing the button a second time disables the indicator.

Indicators on the Hard Drives

CD-ROM/DVD-ROM Indicator

Lights up green when the data storage medium is accessed.

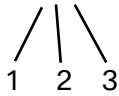
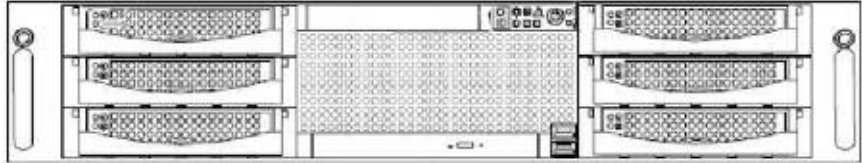

Index	Explanation
1	Drive indicator
2	Eject button
3	Provision for manual opening of CD/DVD drive

Hard Disk Drive Indicators

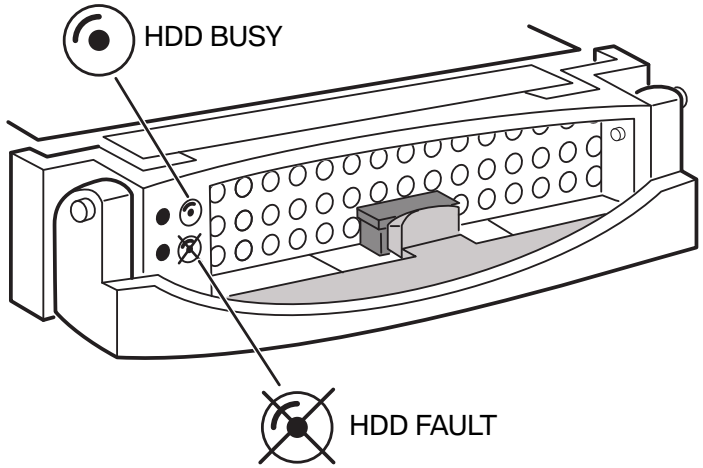

3.5 inch HDD module: Indicators

HDD Module Indicator

LED green	HDD BUSY	
	- lights up	HDD in active phase (drive active)
	- does not light up	HDD inactive (drive inactive)
LED orange	HDD FAULT (in conjunction with a RAID controller)	
	- does not light up	no HDD error
	- lights up	HDD faulty or rebuild stopped (drive is defective, must be replaced; a rebuild operation was stopped or the bay is not properly connected.)
	- flashes slowly	HDD rebuild (data recovery is run after a drive has been replaced)
	- flashes quickly	HDD identify (drive is detected)
	- flashes quickly (four times/pause)	HDD predicted fault (probable drive fault)
	- flashes quickly (two times/pause)	HDD hot spore (Hot spare drive active. The corresponding drive has failed.)

The Rear View of the ISIS Server

Ports and Connectors

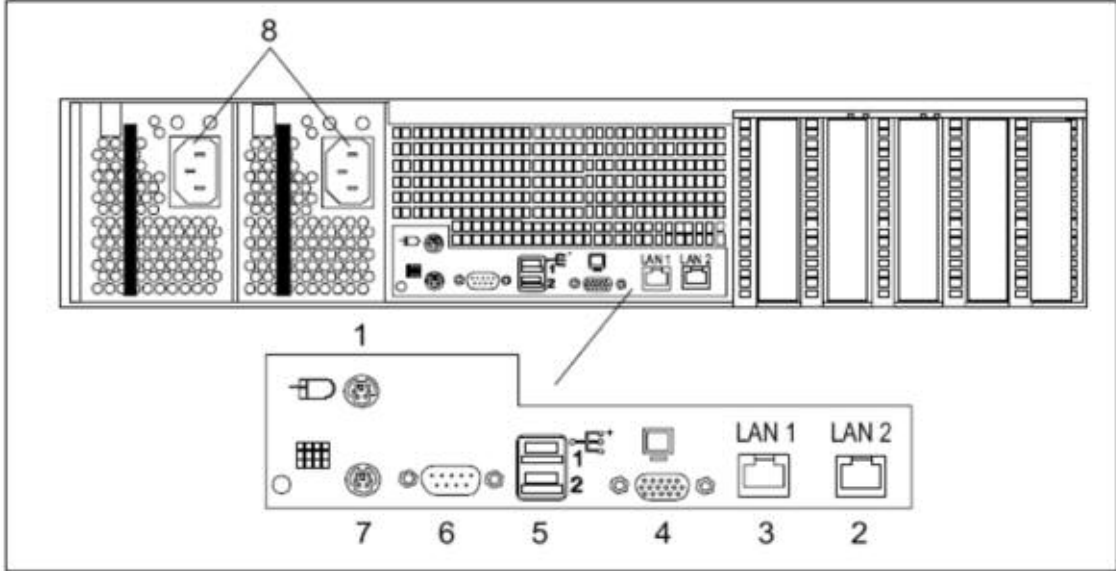

Index	Explanation	Index	Explanation
1	Mouse port (PS/2) (green)	5	USB port 1 and 2 (black)
2	LAN port 2 (10/100 Mbps)	6	Serial port COM1 (turquoise)
3	LAN port 1 (10/100/1000 Mbps)	7	Keyboard port (PS/2) (purple)
4	Monitor port (VGA) (blue)	8	Power supply connectors

Note: ISIS server must be power off to connect to the mouse port, keyboard port, and monitor port (VGA Video).

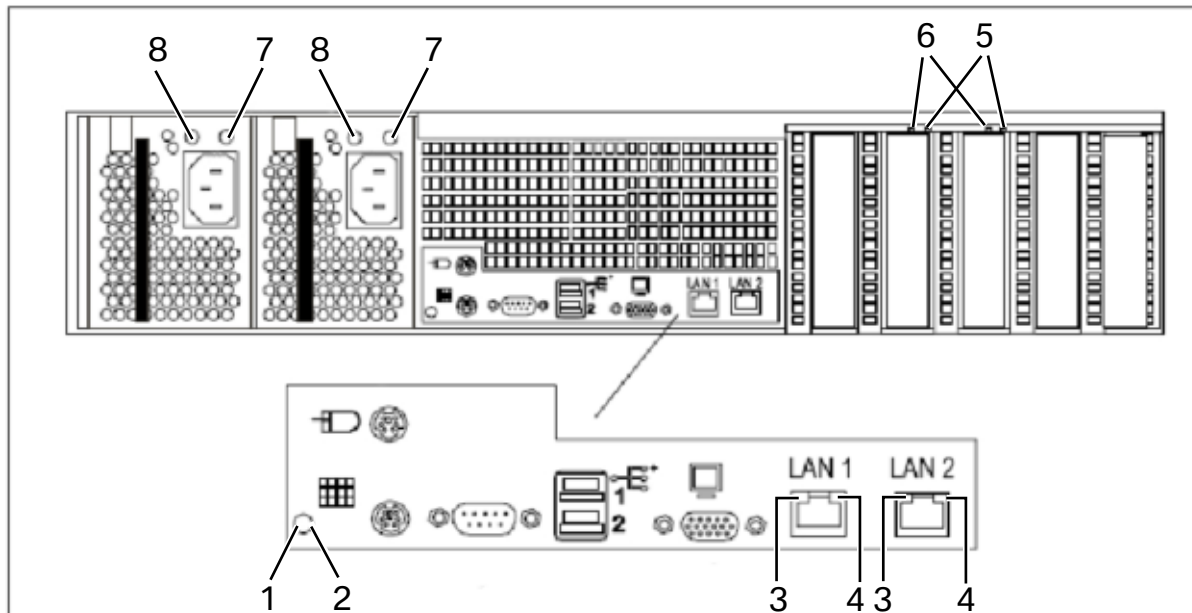

Index	Explanation
1 - 4	Indicators on the connection panel
5, 6	Indicators on the hot-plug PCI slots
7, 8	Indicators on the hot-plug PSU

Indicators on the Connection Fields

1	<p>Global Error Indicator (orange)</p> <p>Does not light when the system is ok. No service incident or critical event has occurred.</p> <p>Lights orange when a prefailure event has been recognized. Users can check system and event log.</p> <p>Flashes orange when a critical event has occurred. Users can check BIOS setup, system and event log.</p> <p>If the event is still acute after a power failure, the indicator is activated after the restart.</p>
----------	--

2	<p>ID indicator (blue)</p> <p>Lights blue when the system has been selected by pressing the ID button on the front. To deactivate, press the button again.</p> <p>The ID indicator on the front also lights up at the same time. The two ID indicators are synchronized.</p>
3	<p>Lan transfer rate indicator (bicolor)</p> <p>Lights yellow for a LAN transfer rate of 1 Gbps.</p> <p>Lights green for a LAN transfer rate of 100 Mbps.</p> <p>Does not light for a LAN transfer rate of 10 Mbps (or there is no LAN connection available).</p>
4	<p>LAN active indicator (green)</p> <p>Lights green when a LAN connection is available.</p> <p>Does not light when a there is no LAN connection available.</p> <p>Flashes when a LAN transfer occurs.</p>

Indicators on Hot-plug PCI Slots

Indicator LED's label 5 & 6 are not used. Hot plug PCI not populated.

Indicators on the Hot-plug Power Supply Unit (PSU)

LED		Color	State	Meaning
7	Operation	orange	ON	Line voltage OK (standby mode)
		green	ON	Server operating
8	Diagnosis	orange	ON	PSU prefailure
			ON/OFF	PSU fail

LocalView LCD Display

The LocalView module enables you to read status messages of the system directly at the server.

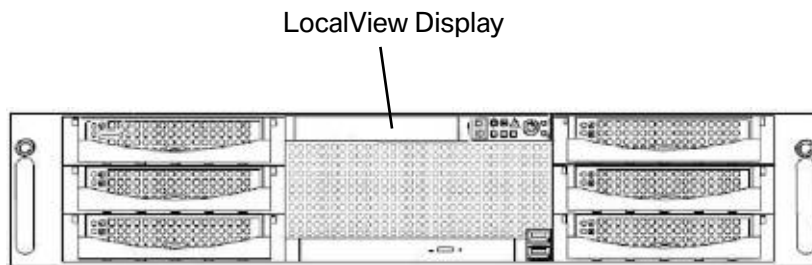

Location of the LocalView LCD display in the front of the server



LocalView LCD display field control element

The status messages on the LocalView display provide information on the system and warns you of hardware problems (e.g. fan failure) or critical temperatures.

Uninterrupted Power Supply (UPS)



“MGE Pulsar M 3000” UPS - (USV in German)

A UPS unit is designed for power supply under voltage events. The UPS unit allows the ISIS servers to operate off the UPS internal batteries. While the line voltage is normal, the batteries get charged. When power fluctuates, only the charging circuit is affected. The batteries continue to provide power to the ISIS servers without interruption. Because the ISIS servers are constantly operating off the batteries of the UPS, the UPS also acts as a line conditioner. The internal UPS batteries provide DC power, and the ISIS servers dual power supplies run on AC power. Inside the UPS is a highly sensitive power inverter circuit that converts the DC into AC.

UPS Battery Module

The maintenance-free battery module of the UPS is a sealed unit. Six 12 volt DC batteries rated at 9 Ah using lead acid battery technology makes up this UPS maintenance-free battery module. Life span for this battery module is approximately 2 years. UPS battery module must be changed out with fresh battery module to insure continuous under voltage protection.

UPS Bridge Time

The UPS bridge time (run time) is determined automatically based on the UPS configuration. In the event that an undervoltage condition is detected, the UPS will automatically send a power down command to the servers in order to safely shut the system down.

The UPS unit is rated at 3000VA/2700 W.

Operating and Display Elements of the UPS

The Rear View

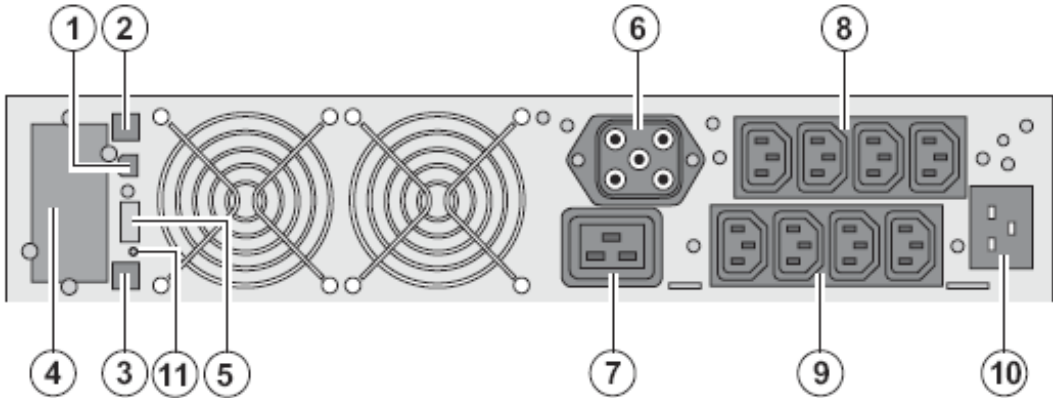

Index	Explanation	Index	Explanation
1	USB communication port	7	16A outlet for connection of equipment
2	RS232 communication port	8	Two groups of 2 programmable outlets for connection of equipment
3	Connector for automatic recognition of an additional battery module	9	Groups of 4 outlets for connection of equipment
4	Slot for optional communication card	10	Socket for connection to AC power source
5	Connector for remote ON/OFF and RPO (Remote Power Off) control	11	LED (SWF) indicating distribution system phase/neutral reversal
6	Connector for additional battery module	10	Sliding element

LAN Communication Interface

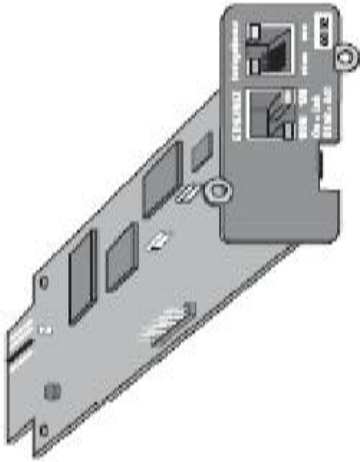

The LAN connection of the UPS Communication interface is connected to the HP LAN switch.

The Front Control Panel

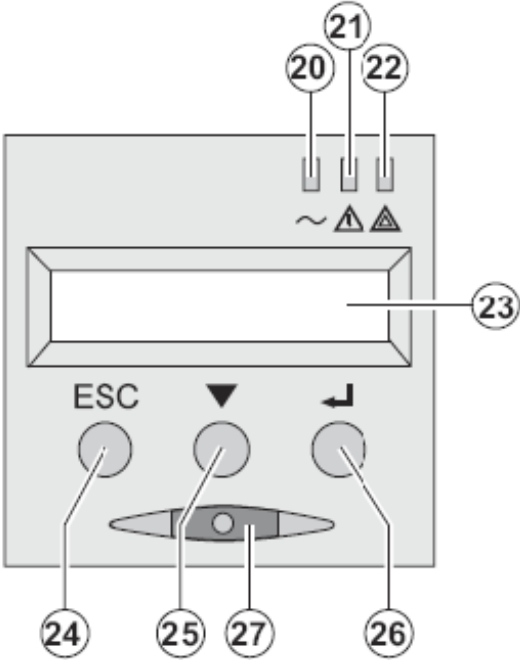

Index	Explanation	Index	Explanation
20	Load protected LED	24	Escape (cancel) button
21	Downgraded operation LED	25	Scroll button
22	Load not protected LED	26	Enter (confirm) button
23	Alphanumeric display	27	ON/OFF button for UPS and outlets

Hot Swap Maintenance Bypass Module

The HotSwap MBP module enables maintenance and , if necessary, replacement of the UPS without having to interrupt the power supply of the connected consumer units (HotSwap function).

Wiring of UPS and HotSwap MBP Module

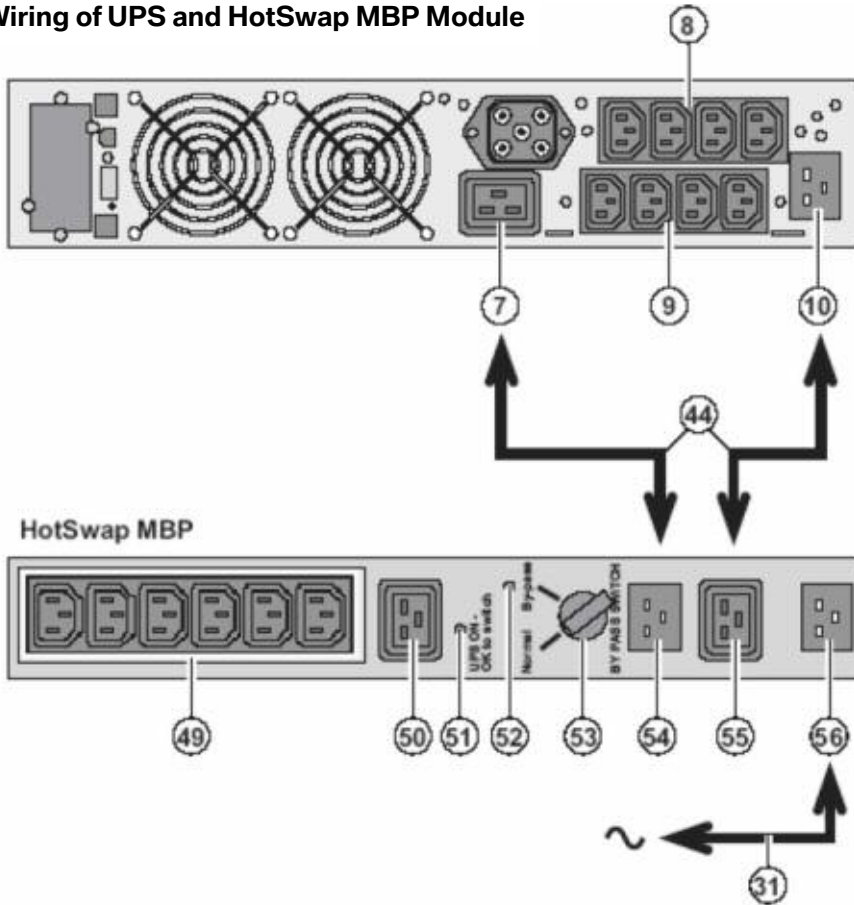

Index	Explanation
7	16A output socket
8	2 groups each, each with 2 programmable 10A sockets
9	Group with 4 normal 10A output sockets
10	Power supply
31	Main leads to the service connection
44	Power connection cable between UPS and HOTSwap MBP module
49	Group of 10A output sockets
50	16A output socket
51	LED "UPS ON - OK" to switch
52	LED "BY-pass"
53	Rotary switch to change over from normal to bypass mode
54	UPS output socket
55	UPS input socket
56	Input socket

HP ProCurve LAN Switch 1800-24

The “HP ProCurve LAN Switch 1800-24” is a plug and play network auto-sensing 10/100/1000 Base-T RJ45 24-port LAN Switch for the center installed ISIS server system.

Front View

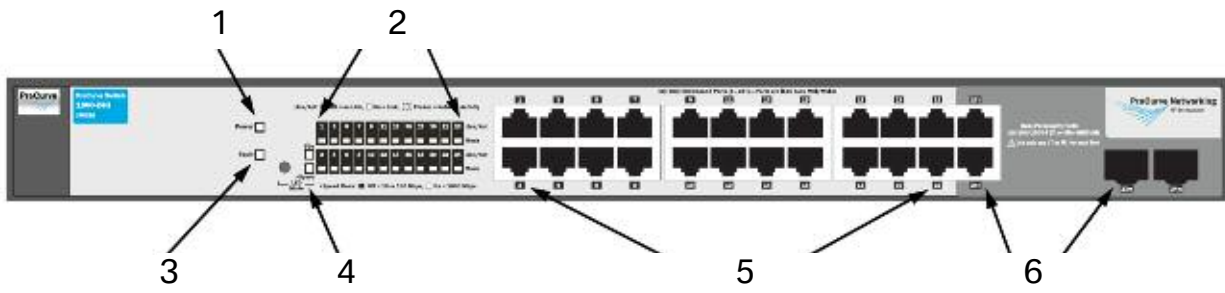

Index	Explanation
1	Power LED
2	Port Link/Act and Mode LEDs
3	Fault LED
4	LED Mode Select button and indicator LEDs
5	10/100/1000Base-T RJ-45 connections
6	Dual personality connections for mini GBIC plug module

Note: All of the internal Cat 6 cabling in the ISIS server rack cabinet is labeled.

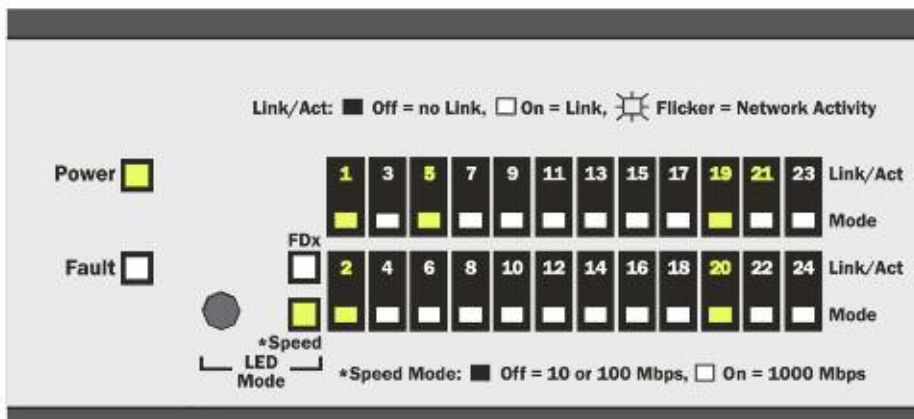
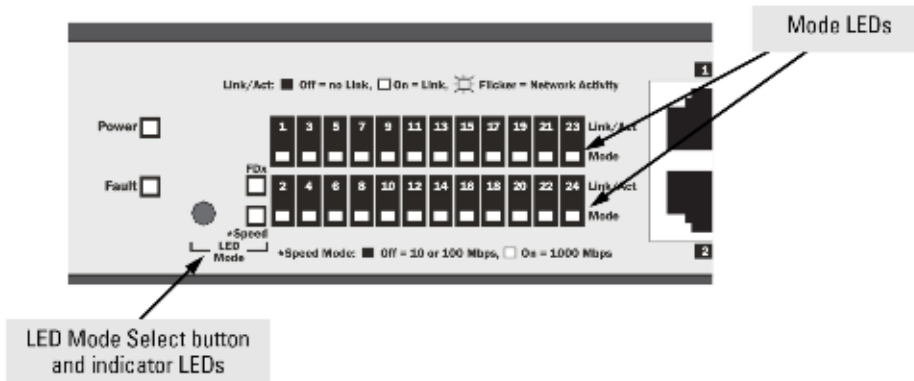

LEDs

The front panel of the switch provides status LEDs for system monitoring. The following table details the functions of the various indicators.

System LED	State	Explanation
Power (green)	On	The switch is receiving power.
	Off	The switch is NOT receiving power.
Fault (orange)	On	On briefly after the switch is powered on or reset, at the beginning of the switch self test.
	Blinking*	A fault has occurred with the switch fan.
LED Mode Select (2 green LEDs)	FDx	Indicates the port Mode LEDs are lit for ports that are in full-duplex mode.
	Speed	Indicates the port Mode LEDs are lit for ports that are in 1000 Mbps mode.
*The blinking behavior is an on/off cycle once every 1.6 seconds, approximately.		

Cabling

The center/dealer is required to have a Cat 6 network cable running from the center's Cisco 2960G or 3560G LAN switch to the ISIS HP ProCurve LAN Switch 1800-24. This cable can be connected into any of the open ports within the ISIS HP ProCurve LAN Switch range of 5 thru 18.

Internal ISIS Rack Cabinet Cabling

All internal Cat 6 cables are labeled. A cable management system is used in the ISIS rack cabinet for controlled routing.

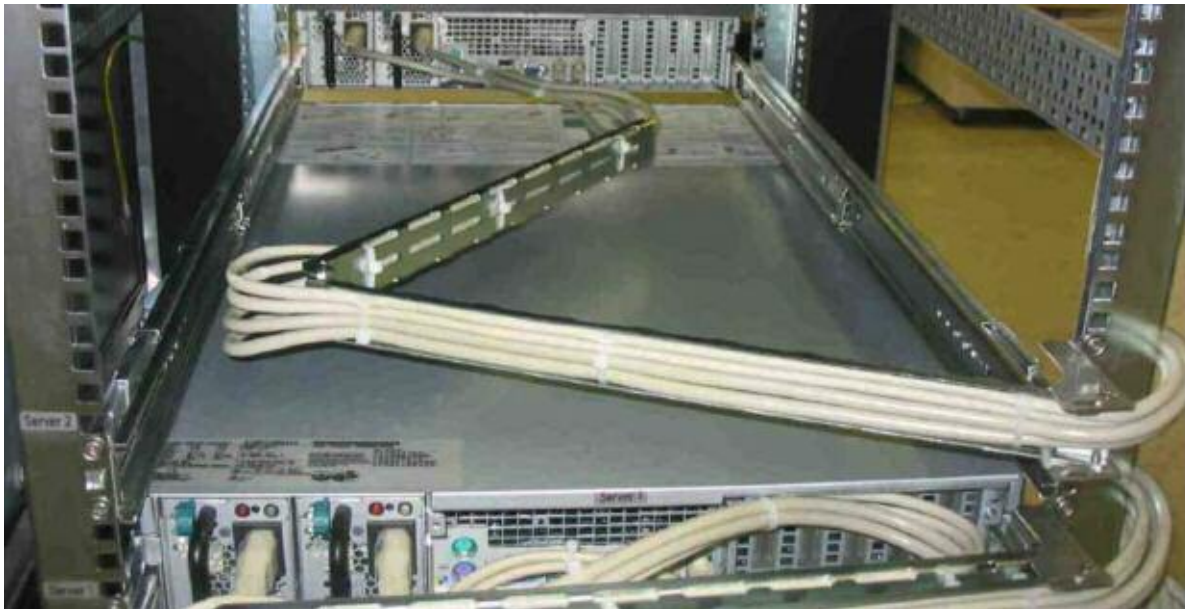

ISIS Ventilated Rack Cabinet Wiring Diagram

