

---

# Table of Contents

## DRIVER INFORMATION SYSTEMS

Subject	Page
<b>E36 Driver Information Systems</b> . . . . .	3
Instrument Cluster. . . . .	6
Instrument Cluster Display Functions. . . . .	8
Cluster Display Changes. . . . .	11
Instrument Cluster Testing. . . . .	12
Check Control. . . . .	21
On-Board Computers/Clock Displays. . . . .	24
BC V Operation. . . . .	25
BC V Test Functions. . . . .	28
Multi Function Clock. . . . .	29
Multi-Function Clock Test Functions. . . . .	30
Digital Clock/ Outside Temperature Display. . . . .	31
Z3/318ti Digital Clock/ On-Board Computer. . . . .	32
On-Board Computer Test Functions. . . . .	33
<b>Instrument Cluster Module (IKE)</b> . . . . .	35
Instrument Cluster. . . . .	37
I.P.O's. . . . .	39
Dynamic Digital Inputs. . . . .	41
Analog Input Signals. . . . .	42
Digital Input Signals. . . . .	43
Output Signals. . . . .	44
Redundant Data Storage. . . . .	45
BC Test Functions. . . . .	46
<b>Check Control Module</b> . . . . .	51
Check Control Module. . . . .	52
CC Display Procedures. . . . .	54
Electronic Oil Level Sensor. . . . .	56
<b>Base Instrument Cluster (KOMBI)</b> . . . . .	57
Base Instrument Cluster. . . . .	58
Digital Dynamic Inputs. . . . .	61
Analog Input Signals. . . . .	62
Digital Input Signals. . . . .	63
Output Signals. . . . .	64
KOMBI I.P.O.. . . . .	65
Redundant Data Storage. . . . .	66
Base Version On-Board Computer. . . . .	67
Base BC/ instrument Cluster Test Functions. . . . .	68

---

## **E36 DRIVER INFORMATION SYSTEMS**

**Model: E36, E36/5, E36/7**

**Production Date: From Production Start**

### **Objectives**

After completing this module you should be able to:

- Recognize the different variations of E36 instrument clusters.
- Know the procedure necessary to replace and code a replacement instrument cluster.
- Understand how to perform an instrument cluster self test on a variety of different models.
- Identify what items are monitored by the E36 Check Control System
- Demonstrate how to perform a self test on the BC V or Z3 BC.

## Introduction

The driver information systems found on the E36 and Z3 models consists of the following components/systems:

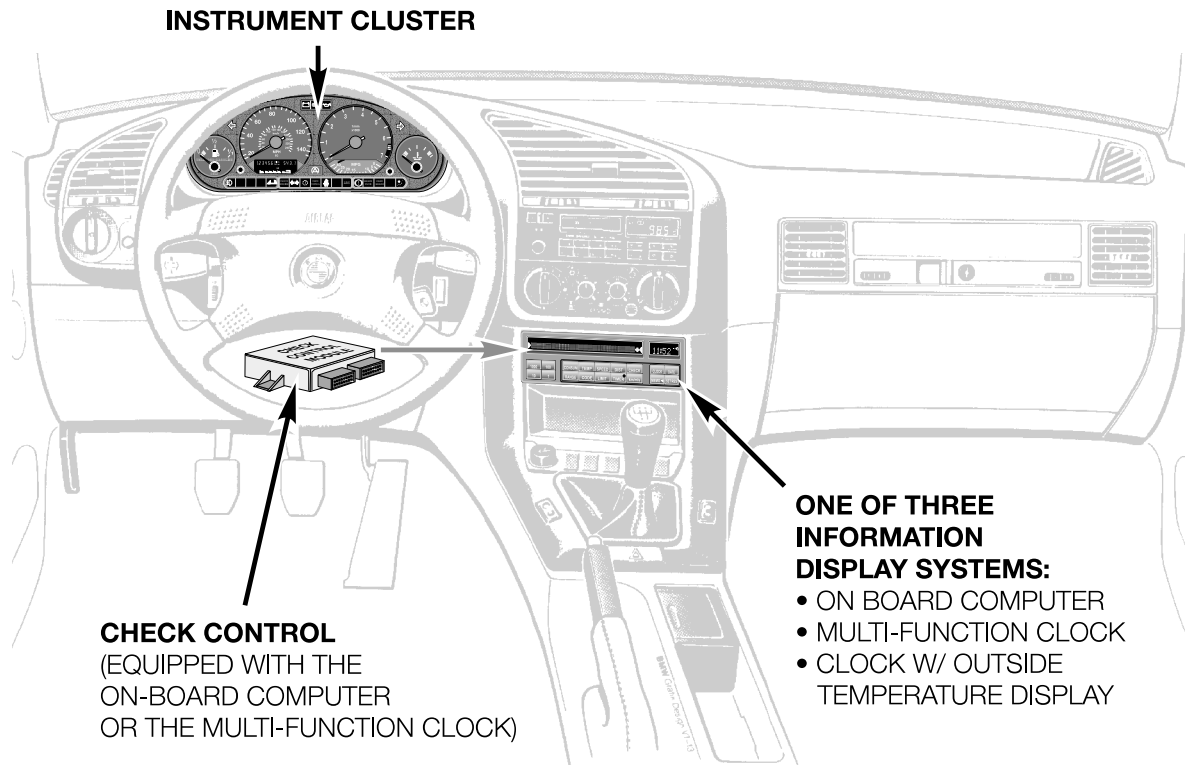

Different systems are found on the E36s depending on the Model Year, standard/optional equipment and/or specific vehicle.

There are two different instrument clusters used on the E36 and Z3 depending on the Model. Although they look the same and function generally the same there are differences between the models and over the model years.

One cluster is connected to the diagnostic link for troubleshooting purposes and the other incorporates self contained test functions. The latest models have both features.



The higher line models incorporate a check control warning system for various lamp failures and low fluid levels. The majority of system failure warnings are through the instrument cluster warning lamps positioned on the face of the cluster.

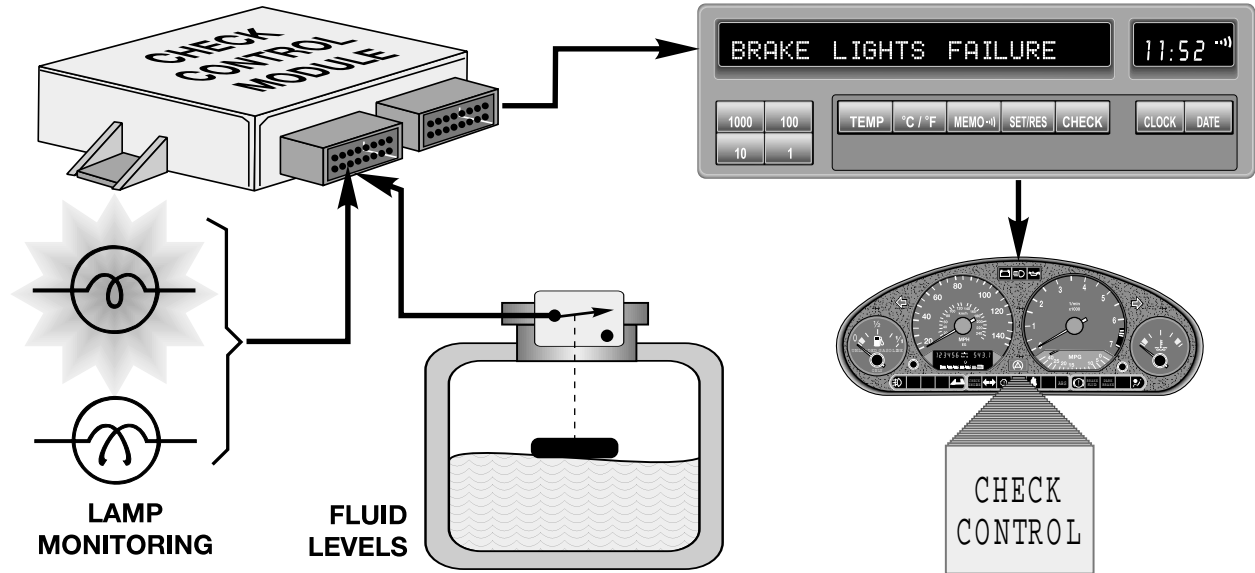

The high line models also have the option of the full touring On-board Computer system.

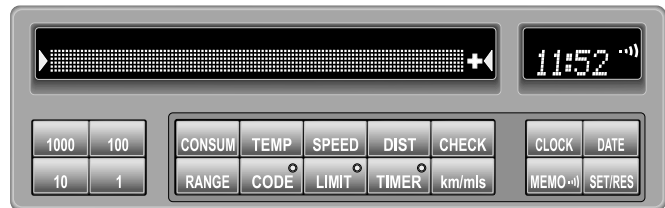

This system incorporates the display matrix for the check control system.

The Multifunction Clock incorporates the Check Control system and a digital clock.

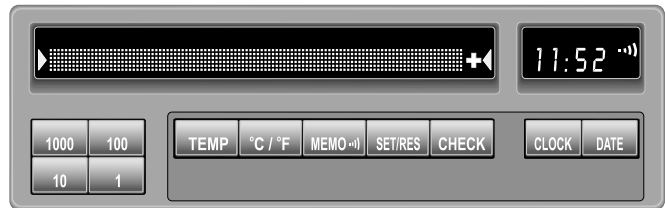

Standard equipment is the digital clock which contains an outside temperature display.

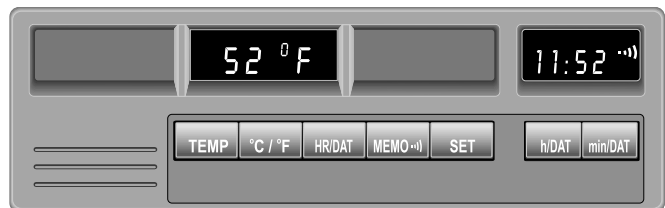

A limited function Board Computer is offered as an option for the E36ti and Z3 models.

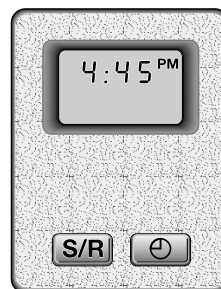

---

## Instrument Cluster

### Overview

The instrument cluster in the E36/Z3 consists of the main circuit board with the microprocessor, driver electronics, LCD display block and the instrument mount with the analog gauges.

There are several different variations of the cluster depending on the model and year.

The general breakdown of cluster variations is as follows:

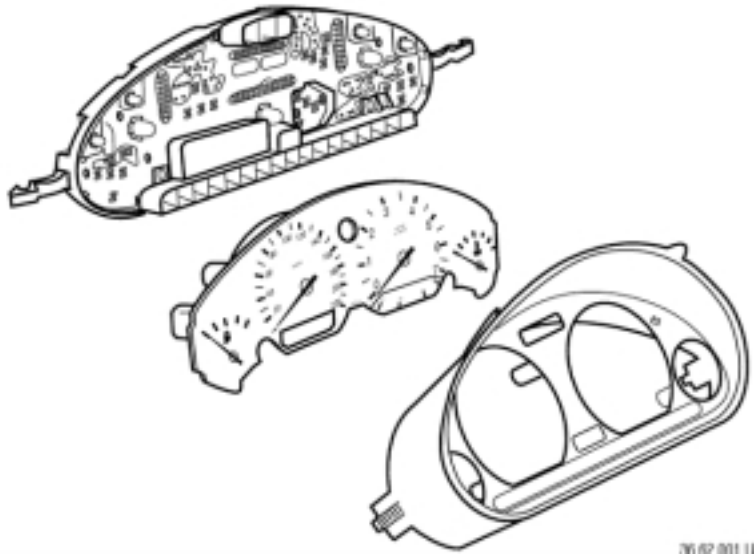

**E36 4 door/Coupe/Convertible/M3:** from 1992 to 1996 model year.

- **Cluster is on the diagnostic link.** The cluster communicates with the DIS for diagnosis and coding functions. This variation uses the central coding key (ZCS) for model specific coding. This cluster also stores the ZCS for replacement control modules in need of coding.

**E36/5 (318ti):** from 1995 to 1998 model year , **E36/7 (Z3):** from 1996 to 1998 model year

- **Cluster is not on the diagnostic link.** This variation uses a separate coding plug for model specific coding, mileage and service interval information transfer into a replacement component.

**E36 4 door/coupe/Convertible/M3:** from 1997 model year to production end.

- **Cluster is on the diagnostic link.** The cluster communicates with the DIS for diagnosis and coding functions. This variation also utilizes the separate coding plug for mileage and service interval information transfer to the replacement component.

**E36/5:** Model year 1999, **E36/7:** from 1999 model year to production end.

- **Cluster is on the diagnostic link.** The cluster communicates with the DIS for diagnosis and coding functions. This variation uses a separate coding plug for mileage and SIA data transfer to the replacement component. This cluster is also connected to the CAN bus.

Though the instrument cluster assembly is the sum of many parts, it is only available as a complete replacement unit with only the indicator lamps and backlighting bulbs being serviceable. The rear of the cluster has pictograms of the indicator symbols for easy identification as shown in example below.

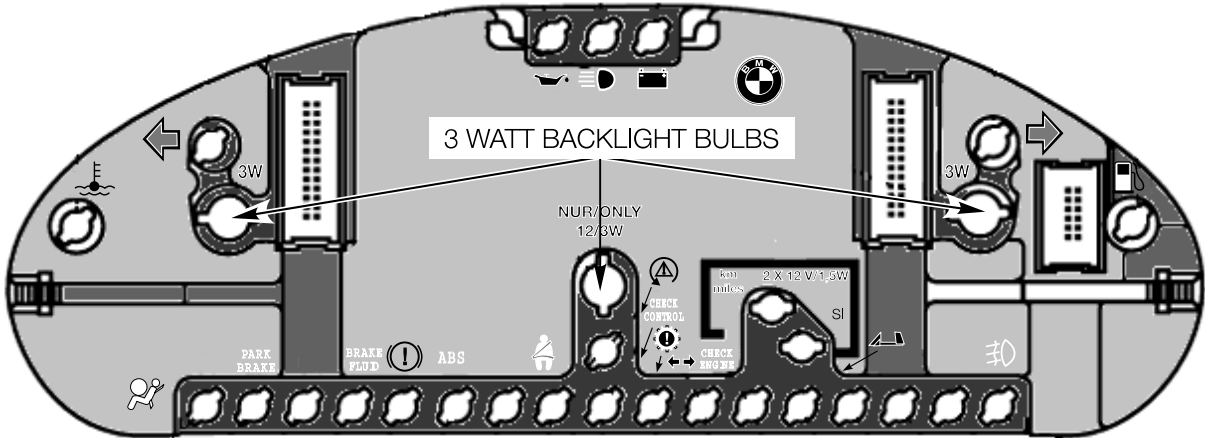

Replacement instrument clusters that are connected to the diagnostic link require coding with the DIS tester or MoDiC using the central coding key (ZCS).

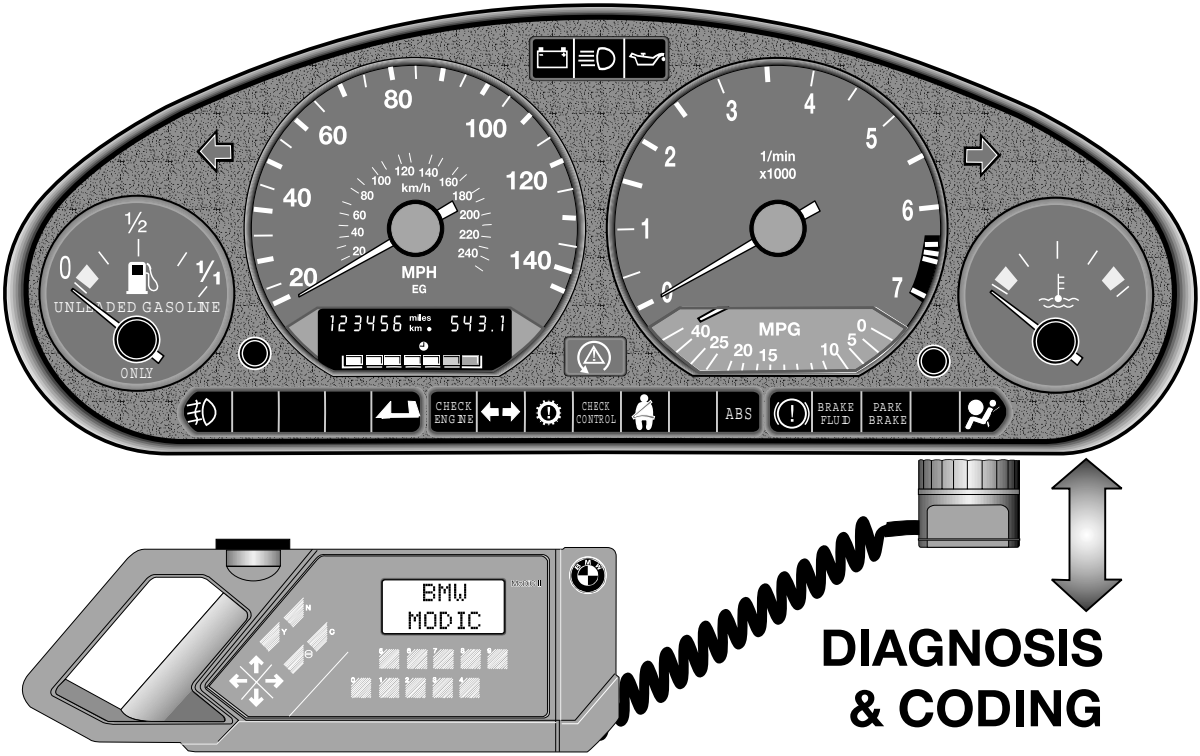

The software and hardware of the cluster are being continuously updated and revised. This requires careful attention to the latest Service Information Bulletins for the latest information and data on cluster compatibility from one version to the next.

## Instrument Cluster Display Functions

All the gauges on the cluster are electronically driven analog needle displays. The inputs to the cluster are processed by the main circuit board as follows:

**Road Speed** - The signal from the rear axle reed contact is processed by the cluster for display. The processed signal is also transmitted as an output of the cluster as "Speed Signal A" to other control modules that require road speed as an input.

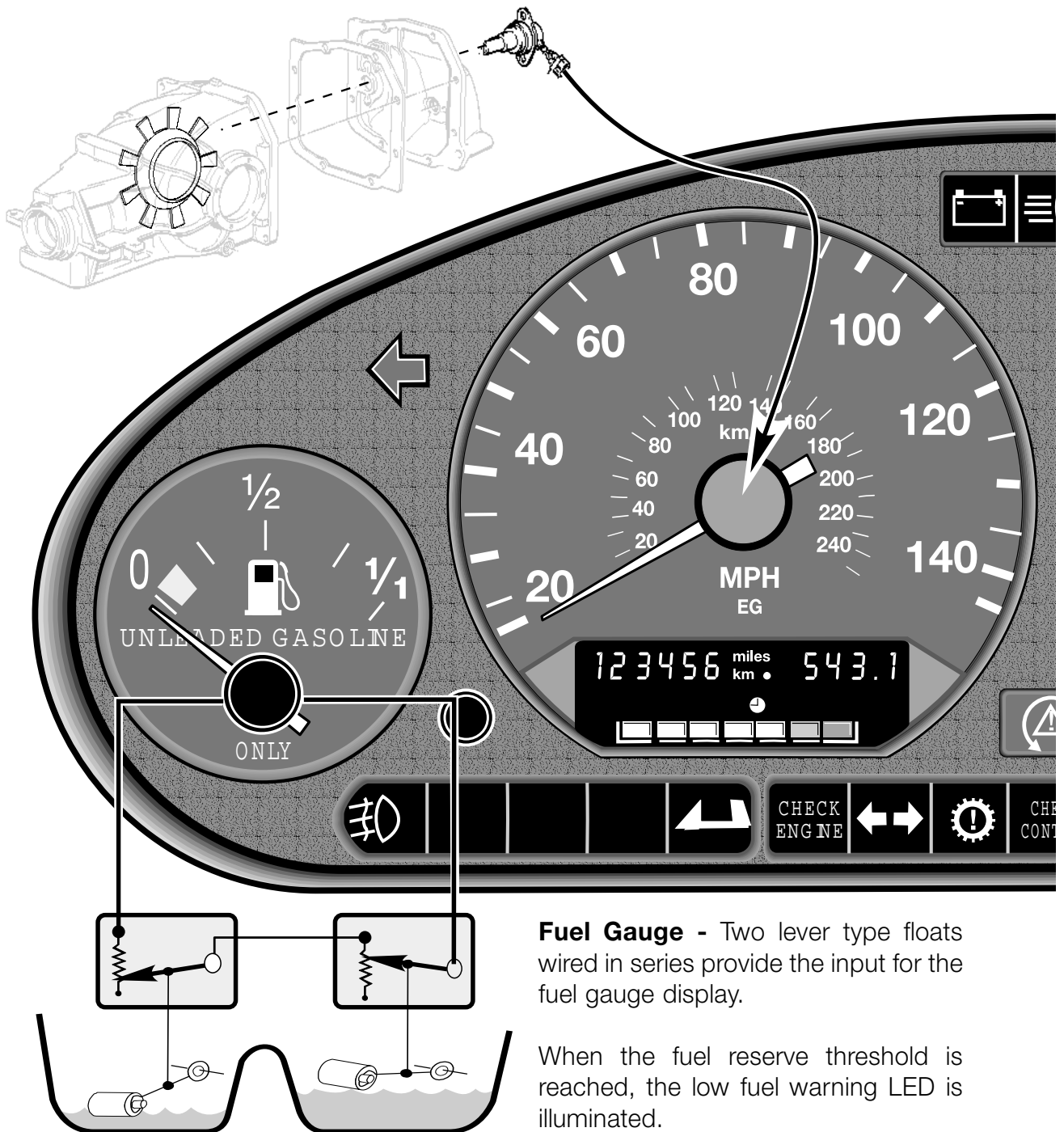

**Fuel Gauge** - Two lever type floats wired in series provide the input for the fuel gauge display.

When the fuel reserve threshold is reached, the low fuel warning LED is illuminated.

**Engine Speed** - The “TD” signal is a processed output of the engine control module that the cluster uses for the tachometer display. This signal is provided by the CAN bus from 1999 for the Z3.

**Economy Display** - The cluster uses the “Ti” and road speed input signals to determine the instantaneous fuel consumption for display on the gauge.

This gauge is not equipped on 318ti and roadster instrument clusters.

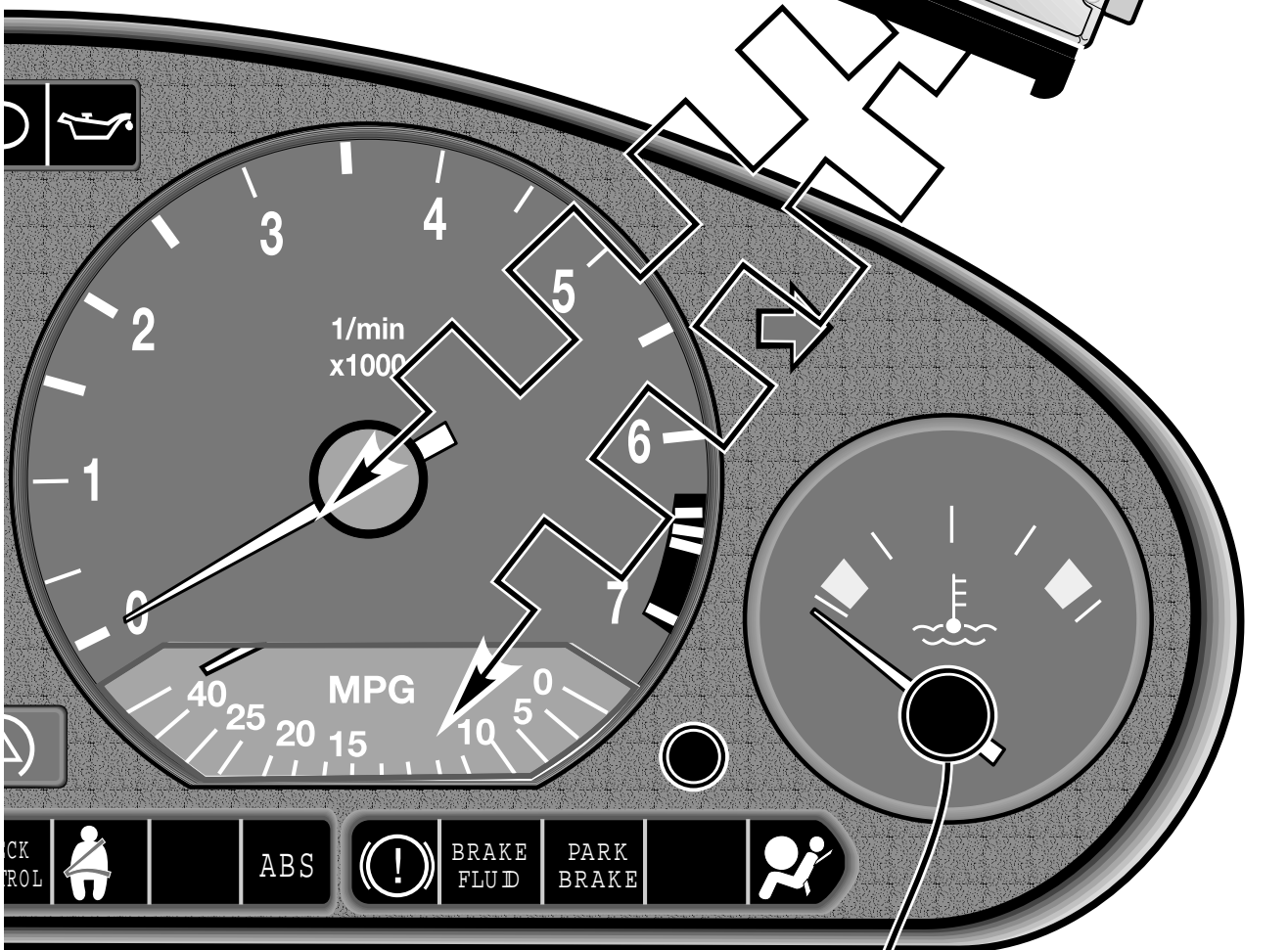
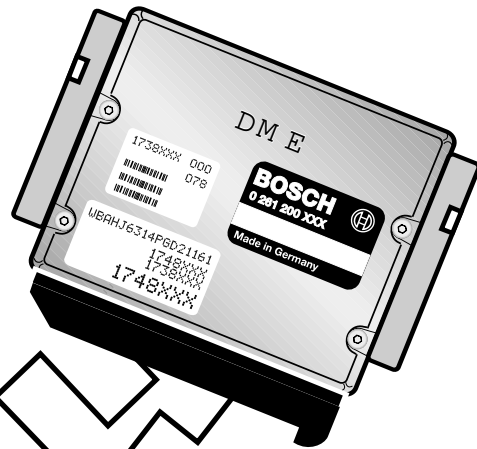

**Coolant Temperature Gauge** - The input signal from the engine coolant temperature sensor is processed for display on the temp gauge.

The overheat warning LED is illuminated if the coolant temperature exceeds approximately 125°C (240°F).



**Total Mileage/Trip Odometer** - The signal from the rear axle reed contact is also processed for accumulated mileage display.

The processed signal is displayed in the LCD block below the speedometer. Depending on model and year, the total mileage reading is stored electronically as follows:

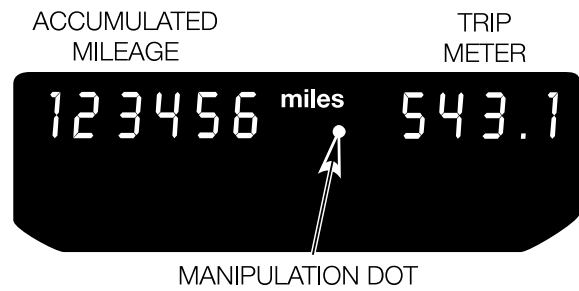

- 1992-1996 E36 4 door/coupe/convertible/M3 in an EEPROM on the main circuit board.
- 1995-1999 318ti in an EEPROM on the main circuit board and in the instrument cluster coding plug.
- 1996-2002 Z3 in an EEPROM on the main circuit board and in the instrument cluster coding plug
- 1997-1998 E36 4 door/coupe/convertible/M3 in an EEPROM on the main circuit board and in the instrument cluster coding plug.

**Service Interval Indicator** - SI information is also displayed in the LCD block with the mileage - when the ignition is switched on. All models use SI II processing for “Oil Service”and “Inspection”intervals.



**Indicator and Warning Lamps** - The various lamps are positioned at the top center and along the bottom of the cluster display. They are controlled internally by the cluster or externally by other sensors and modules where required by legislation.

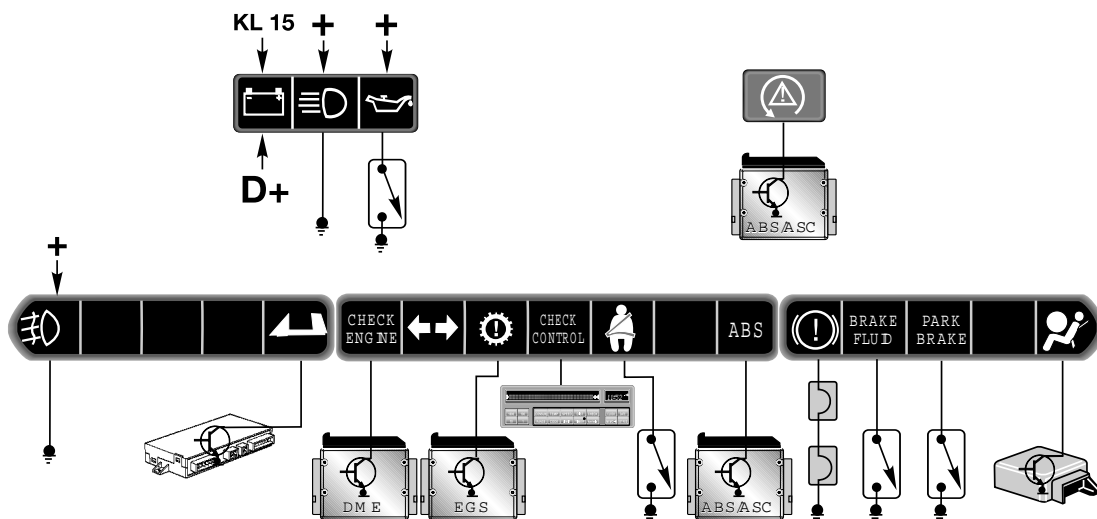



## Instrument Cluster Testing

### 1992 - 1996 E36 - 4 door/Coupe/Convertible/M3

The instrument cluster is connected to the diagnostic link. The majority of the diagnosis and troubleshooting will be carried out using the DIS tester and diagnostic procedures.

There is a self test that can be carried out on the cluster by pressing the trip odometer reset button and switching the ignition to KL R. All gauges move from the zero position to the maximum display and back again. The warning lamps are illuminated as a bulb check.

In addition, vehicle specific data is displayed in the LCD matrix as follows:

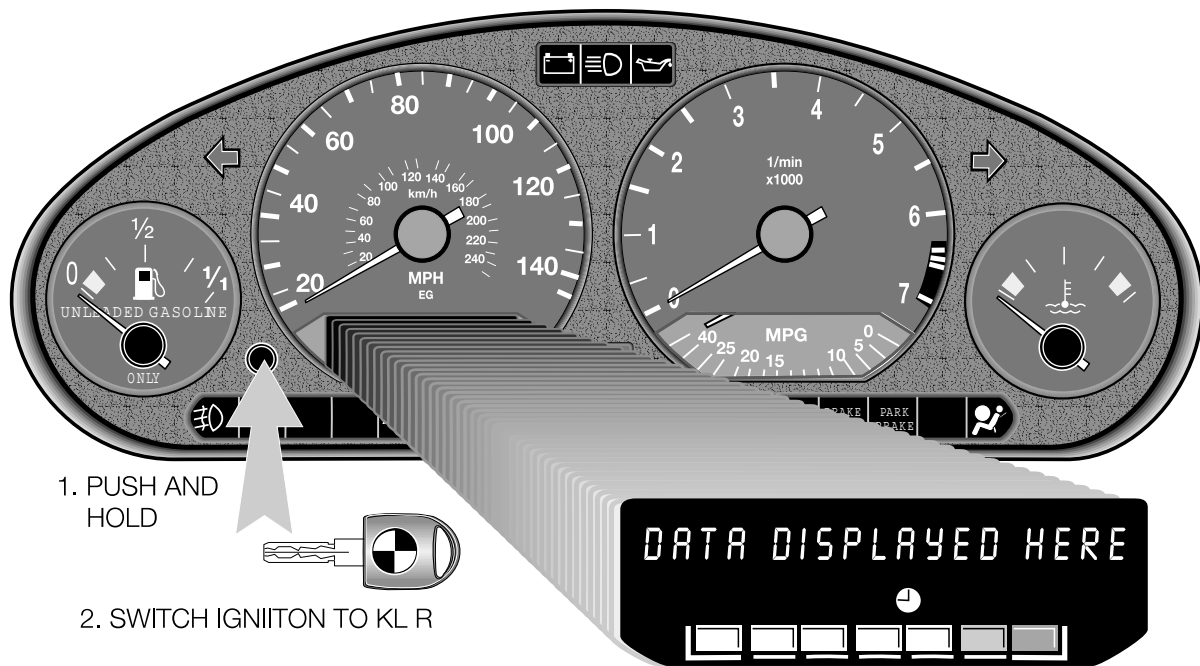

- **BMW PART NUMBER** (6 digits)
- **CODE NUMBER** (5 digits)
- **K NUMBER** (4 digits)
- **CHASSIS NUMBER** (5 digits)
- **SOFTWARE VERSION** (3 digits)
- **REVISION INDEX** (2 digits)

The self test is canceled by switching the ignition off or to KL 15.

---

## 1995 - 1998 E36/5 (318 ti)

## 1996 - 1998 E36/7 (Z3 roadster)

## 1997- 1998 E36 4 door/Coupe/Convertible/M3

The 318ti and Z3 clusters prior to 9/98 are not connected to the diagnostic link for troubleshooting. However they do incorporate several built in test values that can be accessed through the LCD matrix display.

Starting with the 1997 model year production, the balance of the E36 line also has these test functions in addition to the diagnostic link for troubleshooting purposes. there are 15 different test functions that can be used to check various outputs of the cluster and the status of various input signals.

- Test functions **1-4** are unlocked tests and can be called up at any time for display.
- Test functions **5 -14** are locked and require unlocking the test mode before they can be displayed.
- Test functions **2-14** can be selected at any time when the cluster is unlocked, even when the vehicle is moving.
- Test function **15** is the lock/unlock function.

### TEST FUNCTION SUMMARY

#### TEST NO. 15

LOCK/UNLOCK - Press and hold the mileage reset button while switching "ON" KL R. "tEst" appears in the digital display.

Pressing the reset button will scroll through the test functions until "tEst 15 L ON" is displayed.

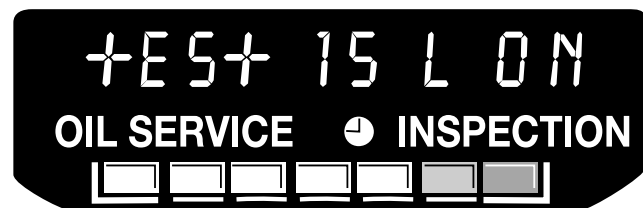

Pressing and holding the reset button for three seconds will cause the display to cycle back and forth between ON/OFF. With "tEst L OFF" displayed any test function can now be accessed.

#### TEST NO. 01:

INSTRUMENT CLUSTER SELF TEST - All of the gauges are activated and the warning lamps are illuminated as an output test as described on the previous page. At the end of the test, the cluster exits the test mode.

## TEST NO. 02

ENGINE DATA - This display is an “engine factor” value that is stored in the coding plug. The instrument cluster processor uses this factor in addition to the “TD” signal from the DME control module to process and display tachometer RPM based on the engine installed. For example:

- ENGINE FACTOR 2 = 4 CYLINDER
- ENGINE FACTOR 3 = 6 CYLINDER
- ENGINE FACTOR 4 = 8 CYLINDER

## TEST NO. 03

SI ELAPSED DISTANCE - The total mileage in kilometers since the last reset. Which service is due at the next inspection (OIL SERVICE or INSPECTION).

## TEST NO. 04

SI ELAPSED DAYS - No value for U S vehicles. Relates to Euro annual inspections.

## TEST NO. 05

SI EVALUATION FACTORS - For engine speed and temperature thresholds being passed.

Display: n = 0 or 1. engine speed  
t = 0 or 1. engine temperature

## TEST NO. 06

FUEL LEVEL AND COOLANT TEMPERATURE - Display of hexadecimal codes in relation to gauge position.

FUEL GAUGE	HEX VALUE
• “A” (empty)	0d
• End of reserve	37
• “B”	54
• “C”	90
• “D”	c4
• “E” (full)	f0

ENGINE TEMP GAUGE	HEX VALUE
• “A”	ce
• “B”	6d
• “C”	5c
• “D” (center)	4f-23
• “E”	1e

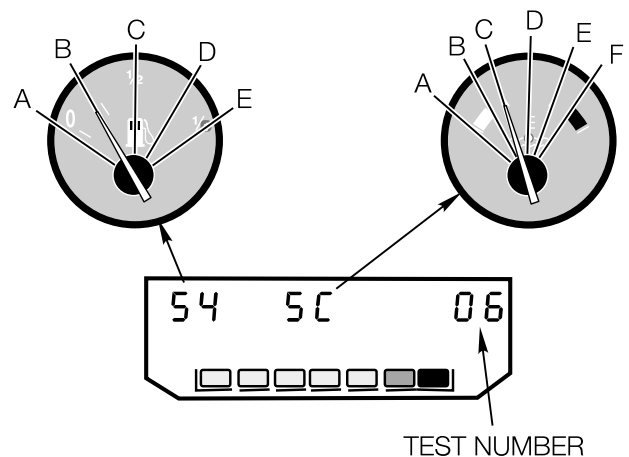

## TEST NO. 07

ENGINE SPEED - Display of current engine speed.

## TEST NO. 08

ROAD SPEED - Display of current road speed in km/h.

## TEST NO. 09

DISTANCE READING Test - 09 allows the total stored mileage to be updated if one of the storage components has to be replaced. This test step will be used if the manipulation dot is illuminated in the cluster display. The display will show the component with the lower mileage for example:

**Display of:** 012654 I indicates that the mileage in the internal EEPROM is lower than the mileage stored in the coding plug.

**Display of:** 000325 E indicates that the mileage in the external coding plug is lower than the total mileage stored in the internal EEPROM.

Pressing the reset button for 4 seconds will over write the lower mileage with the higher mileage and cancel the manipulation dot. The SI data will also be transferred at the same time.

## TEST NO. 10

STATUS BITS (INPUT SIGNALS) - The status of digital inputs to the cluster are displayed as 0 or 1.

Display: 0 = input low

1 = input high

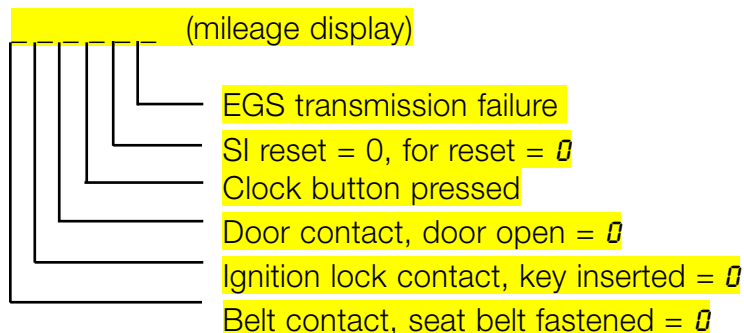

---

**TEST NO. 11**

STATUS BITS (OUTPUT SIGNALS) - The status of digital outputs is displayed.

Display: 0 = output inactive

1 = output active

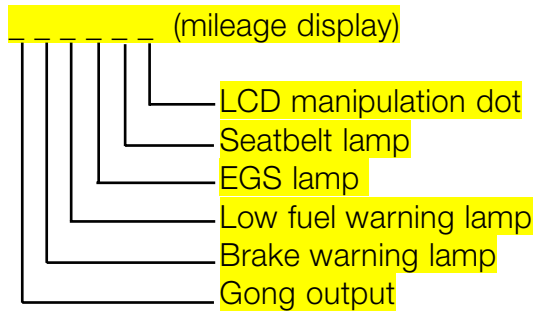

**TEST NO. 12- NOT USED**

**TEST - 13**

COUNTRY CODE OF CLUSTER - The display indicates the country version of the cluster. This cannot be changed in the workshop.

Display: USA 02

**TEST NO. 14**

SOFTWARE RESET - The reset must be carried out if any faults are present that are not plausible before any components are replaced. After the reset, the system will exit the TEST mode and the lock will be reactivated.

---

---

---

---

---

---

---

---

---

---

## 1999 E36/5 (318 ti)

## 1999 - 2002 E36/7 (Z3 coupe and roadster)

For model year 1999 the 318ti and the Z3 received an updated instrument cluster. In addition to the fault memory and diagnostic link the instrument cluster also contains 21 test functions similar to the base cluster of the E39/E53.

- Test functions 1 & 2 are always unlocked.
- Tests 3 through 21 are only accessible after unlocking the test function. Test 19 is the unlock function.

## Test Function Summary

**TEST 01.** - Vehicle specific data including:

### SubTests:

**12345**    **1.0** = VIN

**4663**    **1.1** = K-value

**414061**   **5\_1.2** = Part number of cluster

**029000**   **1.3** = Coding/Diagnosis/Bus index

**\_2197**    **1.4** = Manufacturing date (calendar week/year)

**01\_700**   **1.5** = Hardware/software # of cluster (HW:01, SW:7.00)

**FFF\_04**   **2\_1.6** = Injection status, number of cylinders, engine factor

**\_02\_00**   **\_1.7** = Can Index

**TEST 02.**    Cluster System Test - activates the gauge drivers, indicators and LEDs to confirm function.

**TEST 03.**    SIA data

### Sub Tests:

**1500**    **3.0** = **Z3**-Consumption in liters since last SI reset.

**318ti**-Distance in miles since last reset.

**0**        **3.1** = Periodic inspection days (not applicable for US).





---

**TEST 10.** - Country Coding

**Sub Test:**

**02 10.0** = USA

**TEST 11.** - Cluster code

**Sub Test:**

**FFFF08 11.0** = Cluster code

**TEST 12.** - Not used

**TEST 13.** - GONG test

**Sub Test:**

**9on9 13.0** = Activate gong by pressing button (gong response is delayed).

**TEST 14.** - Fault memory Hex code (not for diagnosis)

**TEST 15.** - Not Used

**TEST 16.** - Transfer of total stored mileage data

This step is used if the total mileage is to be transferred between the coding plug and the internal EEPROM of the cluster. This step extinguish the red manipulation dot after components have been replaced and restore normal data exchange between the two components.

**Sub Test:**

**123459 I\_16.0** = Memory location with lower stored mileage  
I= internal EEPROM, E= external coding plug

**COPY \_16.1** = Copy from higher to lower memory location.

**Note:** 2 miles must accumulate on cluster before disconnecting battery, otherwise step 16 will have to be repeated to extinguish the manipulation dot.

**TEST 17.** - Time of day

**Test 18.** - Not Used

---

## TEST 19. - LOCK/UNLOCK

### Sub-Tests

L-ON...

L-OFF 19.0 =

Display changes from "L-ON" to "L-OFF" every second. To unlock test functions, press the cluster button **immediately** when it changes to "L-OFF".

Tests are automatically locked when exiting test functions.

## TEST 20. - Average fuel consumption - correction factor

The factor follows previous systems, with adjustment range of 750 to 1250. The adjustment method is new for the base cluster. If adjustment is necessary, enter into test 20 using the cluster button.

The correction factor number is changed by using the sub-tests for the "ones, tenths and hundreds of the factor number. The digits will automatically scroll through 0-9 within each group (ones, tenths, hundreds).

### Sub-Tests:

20.0 = Press the button to reset display to 1000

XXX9 20.1 = Press the button when the correct "ones" position is attained.

XX5X 20.2 = Press the button when the correct "tenths" position is attained.

12XX 20.3 = Press the button when the correct "hundreds" position is attained.

## TEST 21. - Software reset

### Sub-Test:

reset 21.0 = Reset software

## Check Control

### 1992 - 1998 E36 4 door/Coupe/Convertible/M3

The Check Control is an active warning system that displays various lighting circuit failures and low fluid level warnings. It is only available on the listed models if they are equipped with the Multi-Function Clock or On-board Computer. Failure warnings are displayed in the matrix of the LCD panel on these units.

#### The complete system consists of the following components:

- Check Control Module - located below the left side of the instrument panel. The module processes the inputs from the monitored components.
- Check Control display - located in the matrix of the BC or Multi-function clock.
- Check warning lamp - located in the instrument cluster.
- Monitored lamps and fluid reservoirs.

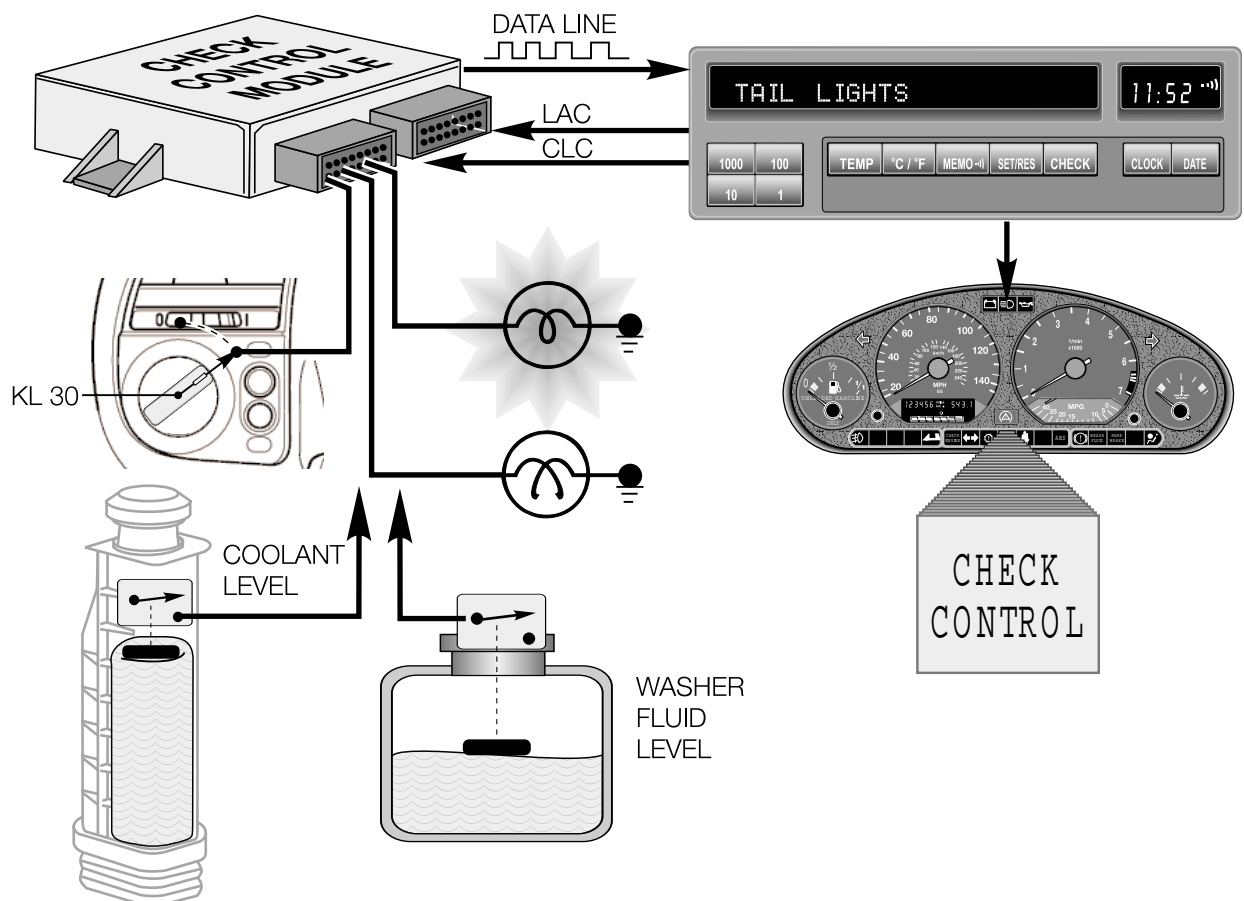

**The following circuits are monitored by the check control system:**

- Windshield washer fluid
- Low beam headlights
- Brake light circuit - including brake light switch
- Coolant level
- Tail lights
- License plate lights

The lighting circuits are warm monitored only - a fault will only be detected when the circuit is on. If a fault occurs in one of the monitored circuits, the check control will post the warning in the 20 digit matrix display and the check warning lamp will illuminate in the cluster depending on the priority of the failure.

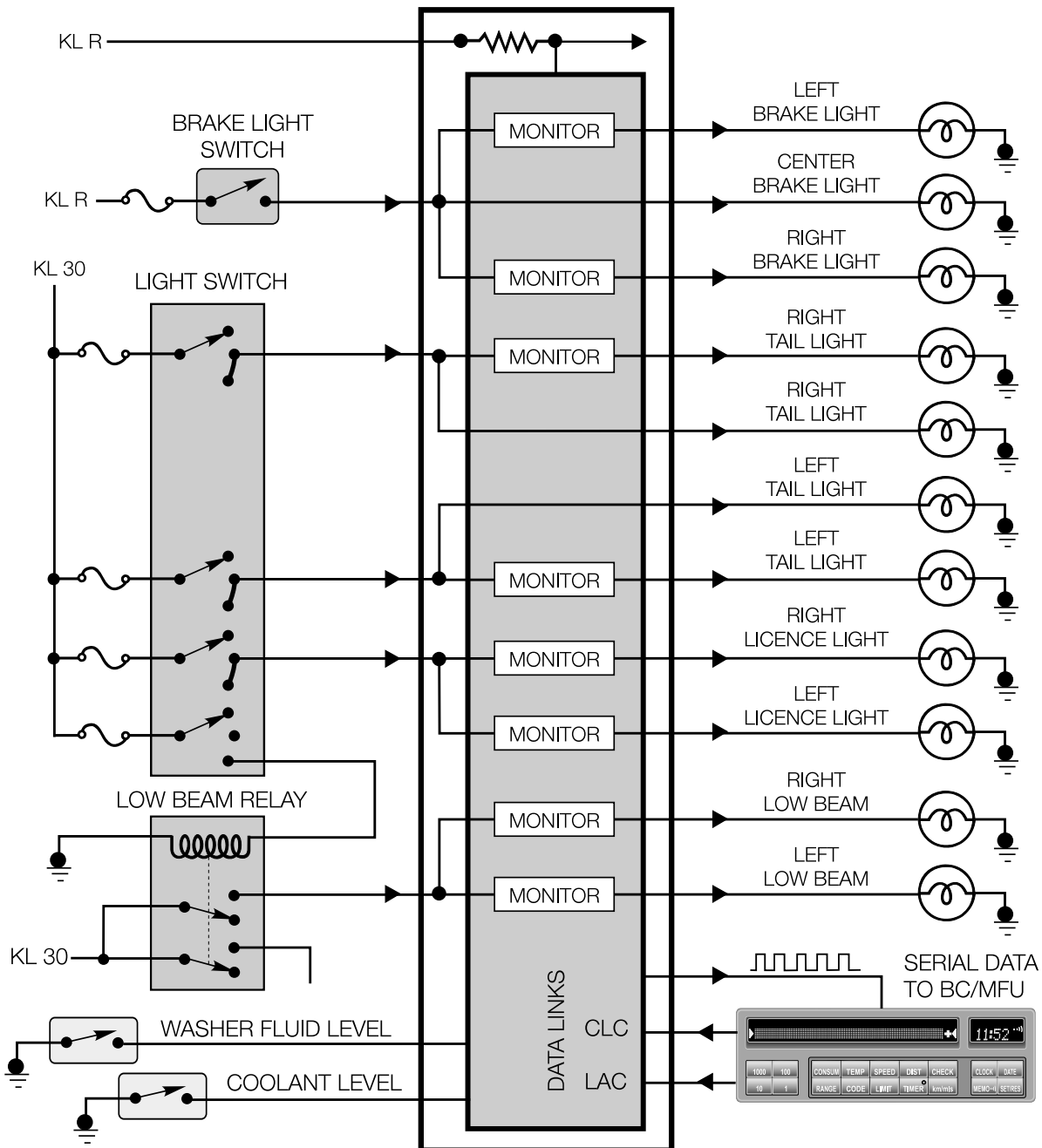

---

## CHECK CONTROL MESSAGE PRIORITIES

There are three priority fault displays in the check control system

**PRIORITY 1:** The brake light circuit is the only priority 1 fault display.

A failure of the brake light circuit (with the exception of one bulb) will be posted in the matrix display when stepping on the brake pedal.



The warning triangles in the display will flash and the check warning lamp in the cluster will also flash for 20 seconds, then remain on steady. Pressing the check button on the matrix panel will cancel the display for 5 seconds and then it will reappear in the display.

**PRIORITY 2:** These failures will appear in the display as soon as they occur. The warning triangles will illuminate steady and the check lamp in the cluster will also illuminate.

Priority 2 failures are only posted for 20 seconds and then are canceled. The warning triangles remain illuminated and the failure message can be recalled by pressing the check button.

The following circuits are priority 2 displays:

- One brake light bulb
- Low beam headlights
- Tail lights
- License plate lights
- Washer fluid



**PRIORITY 3:** Low Coolant Level is the only priority three display. This condition will not be displayed while driving.

A low coolant level condition is held in memory and posted when the ignition is switched off.



The warning is also posted for 20 seconds when the ignition is switched on, however the condition is held in memory until the problem is corrected. The low coolant level display can also be recalled at any time by pressing the check control button.

## On-Board Computers / Clock Displays

There are several variations of the On-Board Computer/ digital clock display systems found on the E36 and Z3 roadster depending on model and year of production.

### 1992 - 1998 E36 - 325/328/M3 - ON-BOARD COMPUTER V (BC V)

The optionally equipped On-Board Computer V is the highest level display system available for the E36.

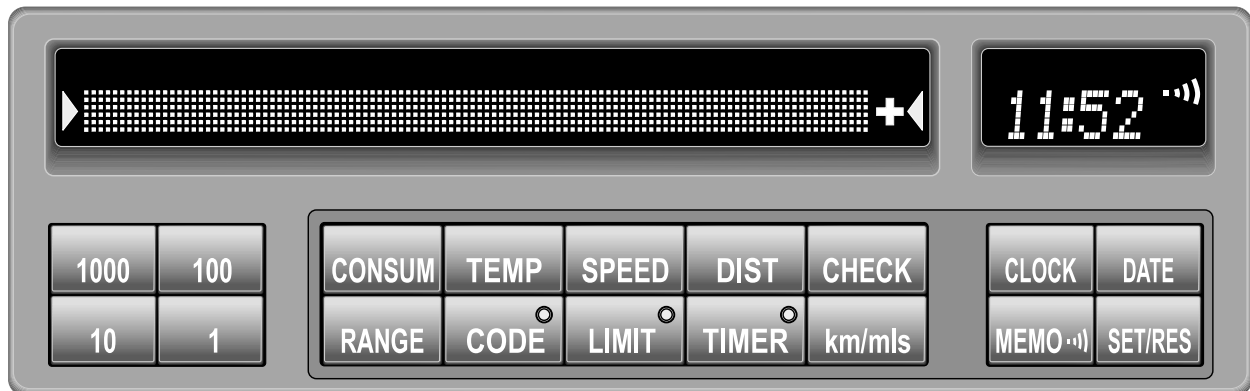



In addition to serving as the check control display block, the BC V offers the following functions:

- Clock/Date with Memo warning (separate display block)
- Fuel Consumption calculation (CONSUM)
- Outside Temperature display (TEMP)
- Average miles per hour calculation (SPEED)
- Distance and arrival time to destination (DIST)
- Estimate driving range on remaining fuel (RANGE)
- Anti-theft code function (CODE)
- Maximum speed limit warning (LIMIT)
- Stop watch function (TIMER)

---



## BC V Operation



**Fuel consumption** - Two average fuel consumption values can be monitored. Pressing the  button once will display the first value and pressing it a second time will call up the second value. The BC calculates the average fuel consumption based on the “ti” and road speed (signal A) inputs.

Pressing  clears the displayed value allowing the BC to start a new calculation.

**Outside temperature** - Pressing the  button will display the current outside temperature. The temperature sensor is located in the front air dam. The sensor’s input is dampened when the vehicle is stopped so that engine heat will not influence the temperature display.



The BC includes an ice warning that will sound the gong and display the outside temperature when it drops below 37°F. The temperature reading will flash anytime it is displayed when the temperature is below this value.



**Average miles per hour** - Pressing the  button will display the average miles per hour. The BC calculates this value based on the road speed signal input and the time. Pressing the  button will start a new calculation.

**Distance/Arrival time** - The feature allows you to program a distance to a destination with the input keys. Press the  button, an area for the total distance in miles to be entered will display. Using the numerical buttons, enter the mileage. Press the  button and the BC will calculate the estimated arrival time based on mileage remaining, average miles per hour the vehicle is traveling and existing clock time.

**Driving range on fuel in tank** - The estimated driving range on the remaining fuel in the tank is calculated by the BC from the “ti” signal and current road speed input signal. A “+” sign along with the mileage indicates a full tank.

**Maximum miles per hour** - A speed limit warning can be programmed into the BC with the input number keys. Once set, the warning gong will sound and the set speed will flash in the display block of the BC.

The current driving speed can be set as the warning by selecting  and pressing the  button while driving.

**Timer Function** - The timer operates as a stop watch. Pressing the  button with the function called up on the display will start/stop the watch. Pressing the  button with the watch running will give a lap time. Pressing the  button with the watch stopped will reset the timer to zero.



**Code Function** - A four digit anti-theft code can be entered into the BC after pressing the **CODE** button when the ignition is switched to KL R. After entering the code and pressing **SET/RES**, the code function is accepted. Switching KL R off arms the function.

The code function is disarmed by entering the code when the ignition is switched on and then pressing the **SET/RES** button.

**When active the code function disables the engine management system.**

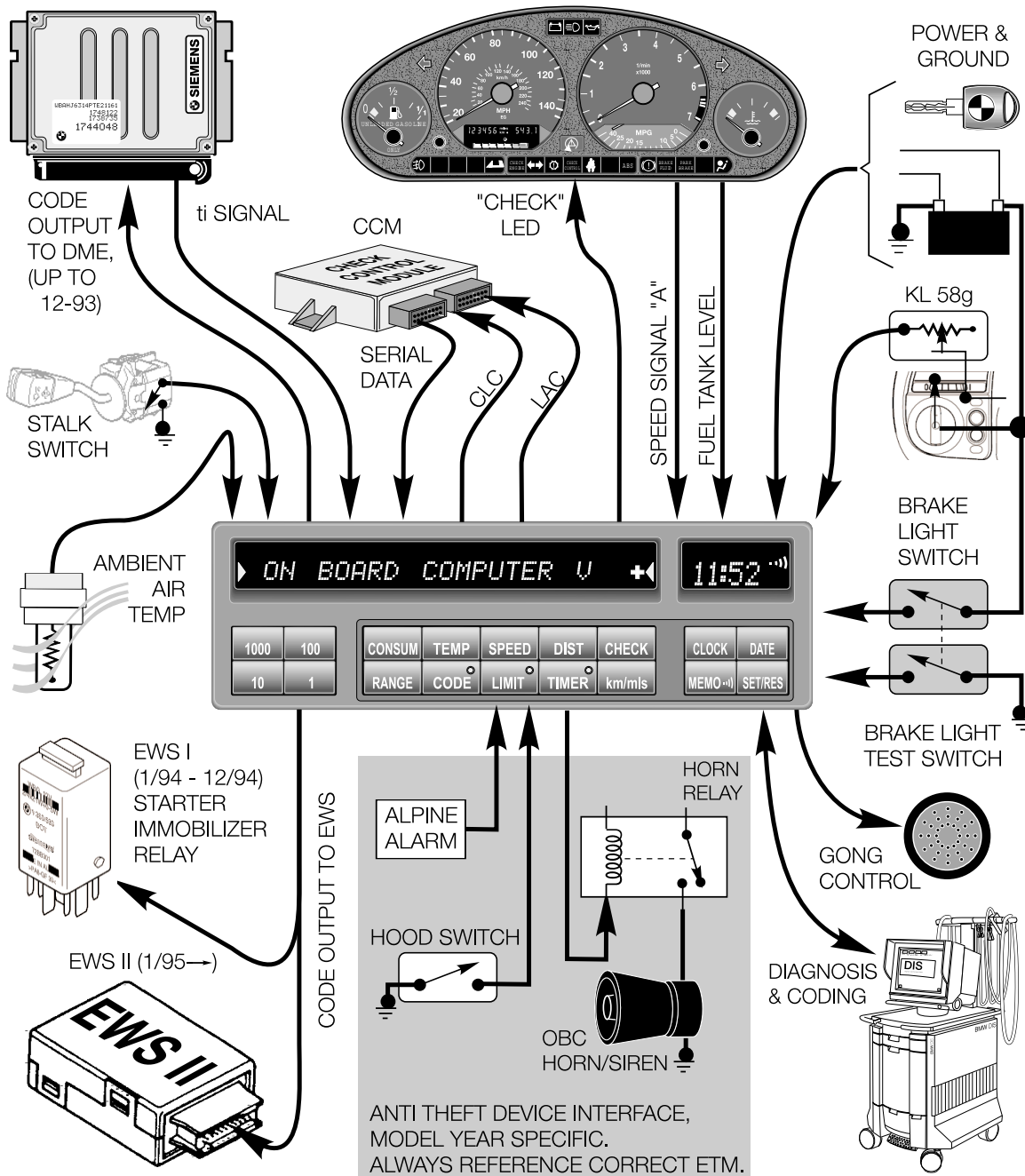



---

## BC V Test Functions

The BC contains test data values that can be accessed for troubleshooting purposes. The following is a list of the test functions and numbers that are stored in the BC:

- 1. Display test** - test all of the LCD segments in the display matrix
- 2. Momentary consumption (L/100Km)** - based on the current “ti” signal and road speed
- 3. Momentary consumption (L/h)** - based on current “ti” signal only
- 4. Range consumption** -
- 5. Momentary range (Km)** - range left on fuel in tank when reserve light is on
- 6.** Not used
- 7. Fuel level from the instrument cluster** - average value
- 8. Momentary speed (Km)** - current speed averaged over 2 seconds
- 9. Operating voltage** - available to BC from KL R
- 10. Language for display** -
- 11. Units readout** - for display of mileage/gallons - etc.
- 12. Average speed for arrival time function**
- 13. Momentary arrival computed**
- 14. ROM** - date
- 15. Readout of fault memory** - vendor use only
- 16. I/O port status** - vendor use only
- 17. Encoding of vehicle specific data** - vendor use only
- 18. Alarm mode** - for BC code function - pulse or continuous tone
- 19. Lock/Unlock function**
- 20. Fuel consumption correction factor**
- 21. Software reset function**

The test functions are accessed by pressing the “1000” and “10” buttons simultaneously. Test functions #1, #10, #14, #19 and #21 are unlocked and can be called up by entering the number and pressing SET/RES.

The other test functions are locked out and test #19 must be used to release the test functions for display. The unlock procedure is as follows:

- Call up test #19 - “ LOCK ON” is displayed in the matrix display.
- Use the number input buttons to enter the sum of the day and month displayed on the clock.
- Press SET/RES and the computer is now unlocked for display of all test functions

To relock the test functions when through with the testing, call up test #19 and press SET/RES twice.



---

## Multi-Function Clock - Test Functions

Several internal test functions can be called up and displayed on the matrix of the multi-function clock. The test functions are not locked and can be accessed at any time.

To call up the test functions the “1000” and “10” input buttons must be pressed simultaneously. the desired test number is then entered followed by the SET/RES button. The following is a listing of the test functions available with the Multi-function clock:

- 0 Display test** - same function as the BC
  
- 1. Language change** - Six languages are stored in the clock for the check control display test including: English UK, French, Italian, Spanish, English US and German. The languages are selected by scrolling with the “1” button, followed by the SET/RES to select the desired language.
  
- 2. Time Mode** - the clock display can be switched from a 12 hour to a 24 hour mode with this test function. Scroll with the “1” button followed by SET/RES to select.
  
- 3. Date mode** - the date can be switched from a month/day to a day/month display with this test function. Scroll with the “1” button followed by the SET/RES button.
  
- 4. Temperature Mode** - the display of the temperature can be switched from F to C with the test function. Scroll with the “1” button followed by the SET/RES.
  
- 5. Compensation factor** - information only
  
- 6. Display status** (HEX) information only
  
- 41.Road speed display (Km)**
  
- 53.Display of “K”number** - correction factor for speedometer

The test function will cancel after several seconds or it can be canceled by pressing the clock button

---

---

---

---

---

---

---

---

---

---



---

## Z3/318ti Digital Clock / On-Board Computer

**1995 - 1999 318ti**  
**1996 - 2002 Z3**

### DIGITAL CLOCK

The digital clock is standard equipment on the ti and Z3 models. The time can be displayed in either the 12 or 24 hour modes. the modes is selected by pressing the “H”and “M”buttons simultaneously.

To set the clock - press the “H”button until the correct hour is displayed. The minutes are set by pressing and holding the “M”button until the correct minute is displayed.



### ON-BOARD COMPUTER

The Z3 and 318ti offer an On-Board Computer with limited functions as optional equipment. The digital clock function of the BC is as follows:

- The time can be displayed for up to 8 seconds with the key switched off. When the key is switched on, the clock is always displayed unless a BC function is called up.
- The time is set using the clock and S/R buttons. Pressing and holding the clock button will put the clock into the time setting mode (the colon will flash). Set the hour first by pressing the clock button until the correct hour is displayed, press S/R, then set the minutes in the same fashion. Finally, press S/R to activate the clock with the new time.



---

## On-Board Computer Functions

- The BC is coded on the assembly line for the specific country version.
- It can be changed in the dealership using the DIS tester or MoDiC.
- All vehicle specific data for the BC's operation is stored in the NVRAM of the BC.
- The BC functions are called up by pressing the turn signal lever.

In addition to the clock it offers the following functions:

**OUTSIDE TEMPERATURE** - the temperature display is dampened, as with other displays to prevent underhood temperatures from influencing the sensor when the vehicle is stopped.

The warning gong will sound when the outside temperature drops below 37°F as with other BC displays.

**AVERAGE FUEL CONSUMPTION** - the average fuel consumption is displayed in MPG. As with other BCs it is calculated from the "ti" and road speed signals.

Pressing S/R with the MPG displayed, will start a new calculation.

**RANGE** - the estimated distance on the remaining fuel is displayed. The range value is determined from the "ti" and road speed signals as with other BCs.

**AVERAGE ROAD SPEED** - The average road speed corresponds to other BCs, pressing the S/R button will start a new calculation.



---

---

---

---

---

---

---

---

---

---



## On-Board Computer Test Functions

There are four test functions available for the Z3/318ti board computer. Press and hold the clock and S/R buttons simultaneously to enter the test functions. Scroll through the test steps by pressing the stalk switch.

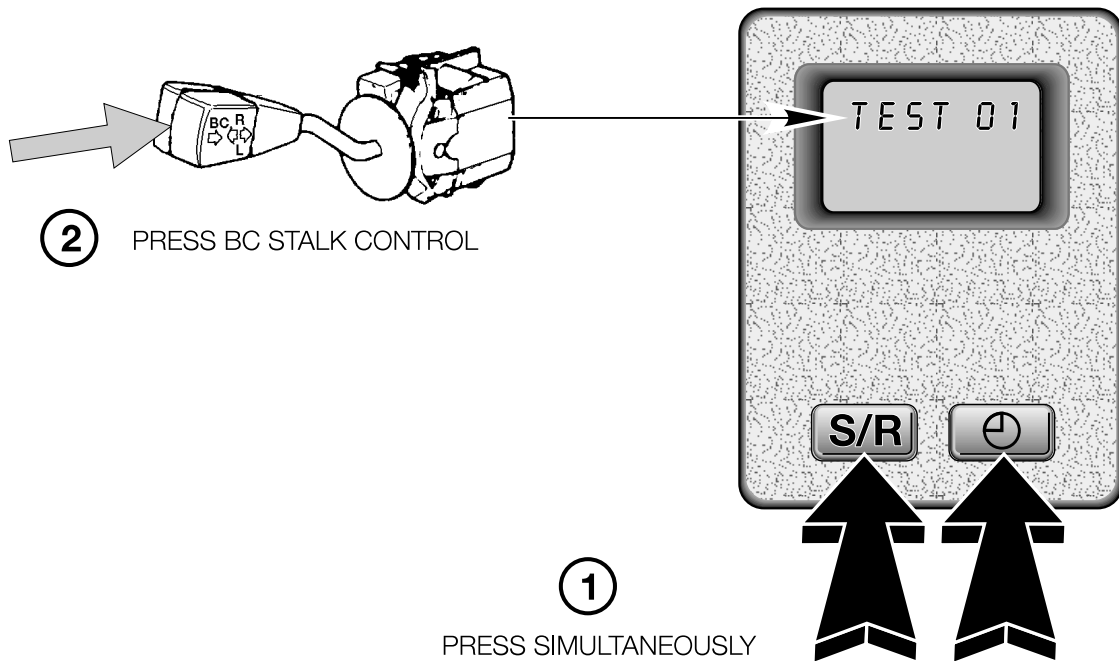

**TEST 1. - 12/24 hour clock mode.** Press the clock button to switch between 12/24 hour display.

**TEST 2. - Display test.** Pressing the S/R button will illuminate all of the LCD segments of the display. the BC will then return to the test mode.

**TEST 3. - Correction factor for the MPG display.** The correction factor corresponds to other BC factors. The value can be corrected from 750 to 1250 by scrolling with the clock button. When the new value is reached it is stored by pressing the S/R button.

**TEST 4. - Acoustic test.** Pressing the S/R button will test the temperature warning gong.

---

---

---

---

---

---

## **INSTRUMENT CLUSTER MODULE (IKE)**

**Model: E38, E39, E53**

**Production Date: All from start of production.**

### **Objectives**

After completing this module you should be able to:

- Know how various input data arrives at the IKE.
- Recognize the various changes made to the IKE.
- Understand the IKE's role as a Gateway Module.
- Describe how redundant data is stored.
- Know how to properly code the IKE after replacement.

---

## Introduction

The instrument cluster is the main Driver Information display unit. The instrument cluster is made up of the IKE and a display unit. This type of cluster is known as a “High version”.

As introduced, the IKE control module was mounted on the back of the instrument cluster and was connected to the cluster with a 46 pin ribbon connector. The two additional connectors contained the D, I and K Busses and the input and output leads to the IKE.

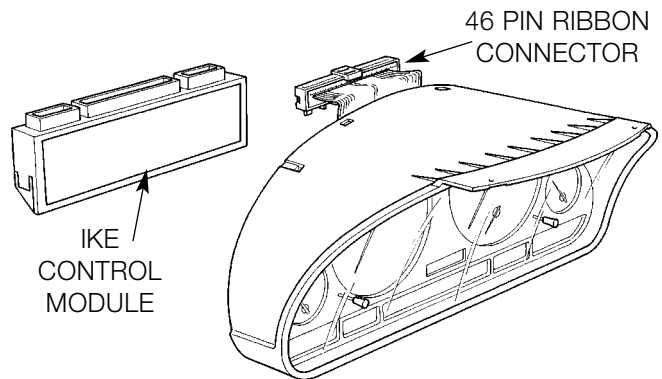

Since 9/97 the external IKE control module was integrated into the display unit creating an integrated component. The CAN bus was also linked to the instrument cluster starting model year 98.

The IKE contains all of the processing electronics for the Instrument Cluster and On-Board Computer.

The Instrument Cluster is merely a display unit and performs no processing. On Board Computer data can be displayed in the MID/BMBT or the matrix display in the cluster.

Signals that are intended for a component that is on the I/K-BUS must be passed on by the IKE. Also, diagnostic data must be passed through the IKE to the “I” and “K” busses as communication between DIS and control modules takes place.

The IKE incorporates an EEPROM for storing the Central Coding Key (ZCS).

## Instrument Cluster

The instrument cluster incorporates the five familiar analog gauges along with indicator/warning lights and Liquid Crystal Displays.



All the indicator/warning lights are LEDs and are not replaceable. Critical warning indicators use two LEDs for safety. There are five conventional bulbs for the back lighting of the LCD which can be replaced if necessary.

The LCD provides:

- 6 digit total mileage
- 4 digit trip mileage
- Manipulation DOT
- Outside temperature display
- 20 digit read-out with reminder arrows
- Service Interval Indicator
- Automatic transmission selector position
- Automatic transmission driving program



When KLR is switched on, mileage and temperature are displayed. All displays are illuminated from KL15.

The back lighting intensity of the LCD's is dependent on available light and is controlled by a photo-transistor in the lower left corner of the cluster. When the parking lights are switched on, the dash mounted dimmer wheel controls the intensity of the back lighting.

## Service Interval Indicator (SIA)

The Service Interval Indicator of the E38 up to M.Y. 96' operates using SIA II. SIA III is used after M.Y. 96' to present vehicles.

The reset of Service Indicator is carried out with the reset tool, DIS, or cluster reset mode (reset mode after 9/00 only).



## Total Mileage/Trip Mileage

Mileage can be displayed with the key off for 25 seconds if the trip meter button is pressed.

Total mileage is stored in non-volatile memories of the IKE and LCM to protect against loss.

## Automatic Transmission Selector Position/Driving Program

As introduced, the selector lever position and driving program were signaled to the IKE from the AGS control module over a single wire circuit. These signals are passed along by the CAN after the CAN bus was connected to the integrated IKE.

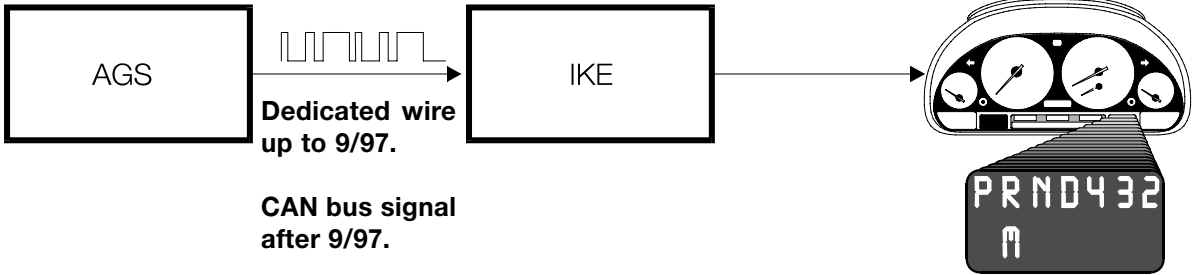

## Analog Instruments

Analog instruments are controlled by the IKE from signals it receives over separate inputs or the CAN bus.

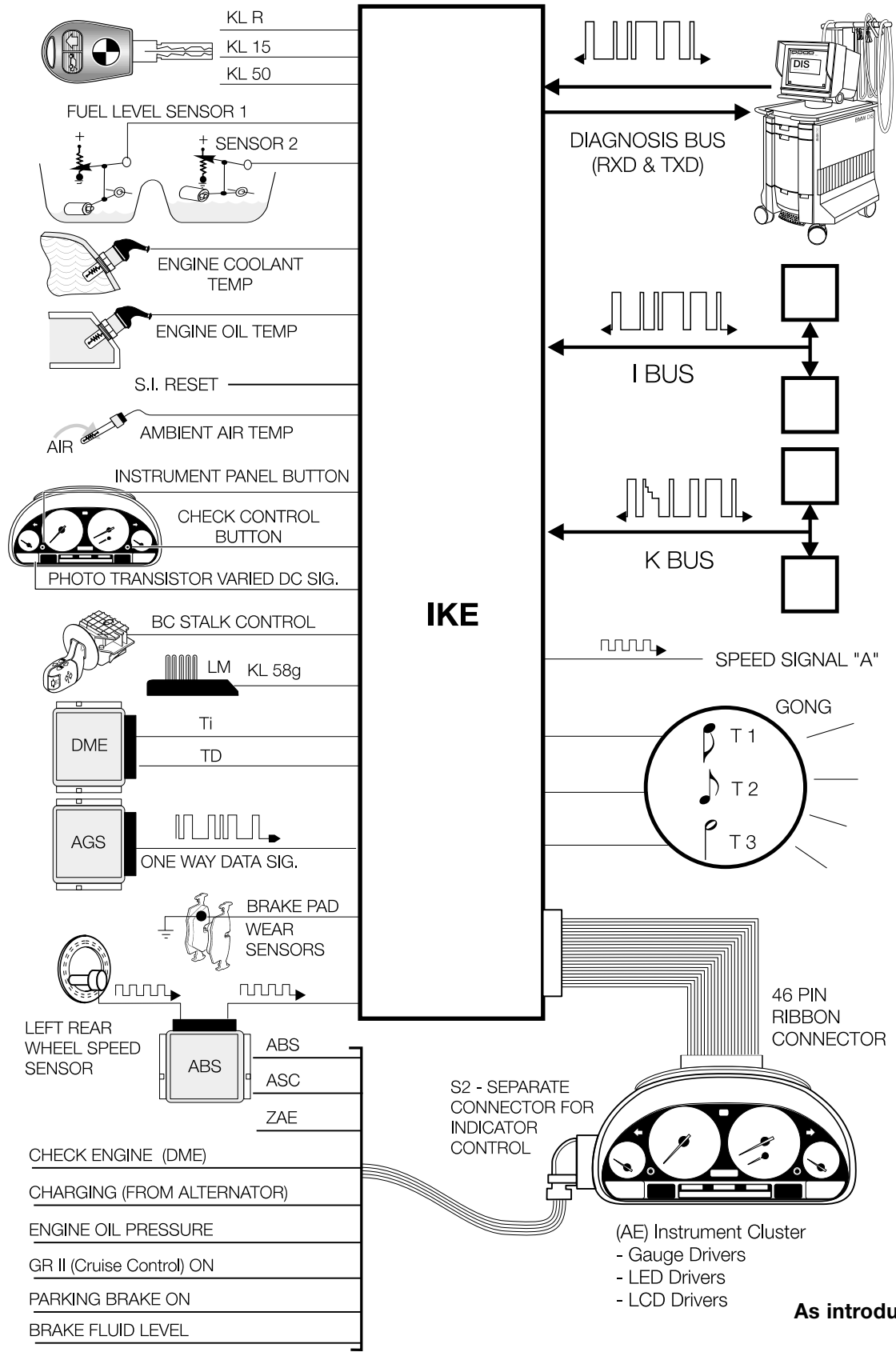

**As introduced**

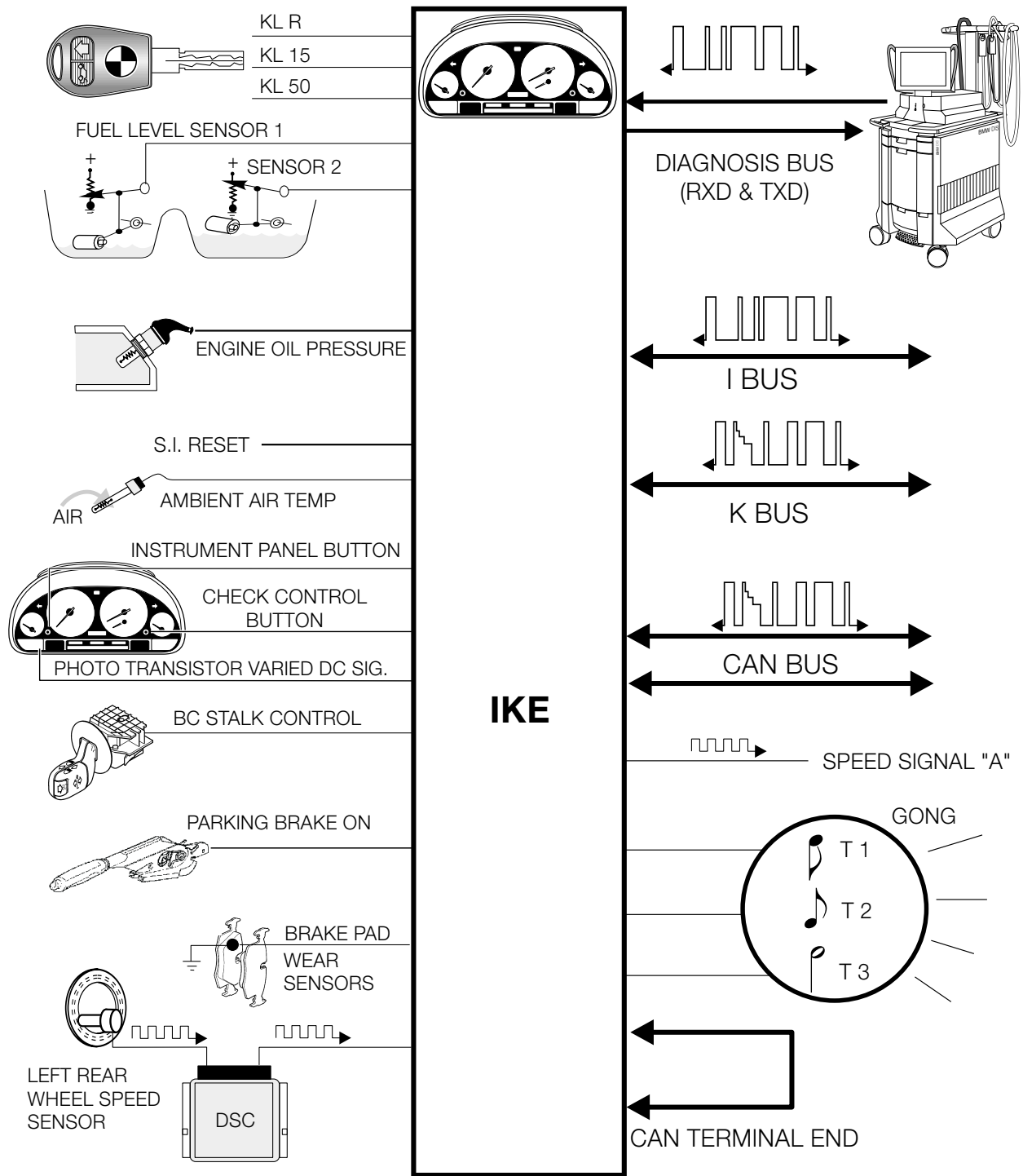

**Integrated IKE as of 9/97.**

## Dynamic Digital Inputs

**Distance signal** - This information is supplied to the IKE by the ASC/DSC control module with a square-wave signal. Pulses from the **left-rear** wheel speed hall sensor are used to produce signal. The IKE processes this for the cluster display and provides a speed signal output on the I / K busses.

**Engine speed signal** - The TD signal is produced by the DME and sent to the IKE. This is a CAN bus signal on vehicles produced after 9/97. Engine speed is re-transmitted over the I/K buses by the IKE. **Note: The wiring continues to exist as in the earlier systems but the cluster is coded to only accept the information from the CAN.**

**Injection Signal** - The DME supplies the signal to the IKE for fuel consumption evaluation. This signal is also transmitted via the CAN on later vehicles.

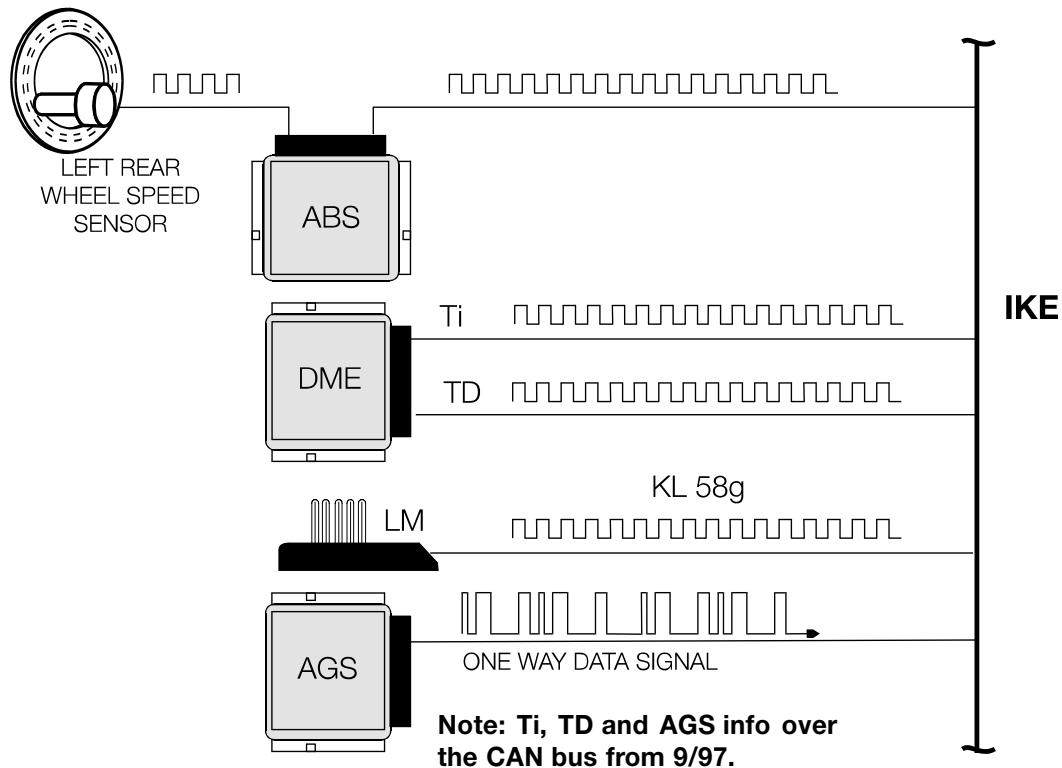

**Dimmer signal** - This is a pulse-width modulated signal from terminal 58, of the Lamp Control Module. It is used to control back lighting of instruments and the LCD and is also transmitted through the I/K buses.

**Transmission Interface** - This single-wire is a serial one-way interface that provides the IKE with selector lever position, driving program and the fault message. This information is provided over the CAN on vehicles from 9/97.



# Analog Input Signals

**Battery Voltage** - The system voltage is monitored by the IKE and sets a fault if it exceeds 16 volts.

**Fuel tank level** - Two lever action sensors are wired in parallel to the IKE. The two variable resistor inputs are processed by the IKE and used to operate the fuel gauge. The reserve light is controlled by the IKE from the sensor inputs.

**Photo transistor** - A variable voltage signal, that is dependent on ambient light, is used for LCD back lighting.

**Coolant Temperature** - A NTC sensor is used by the IKE to measure coolant temperature. This is a CAN bus signal from the DME on vehicles produced from 9/97. **Note: The dual sensor and wiring continue to exist as in the earlier systems but the cluster is coded to only accept the information from the CAN.**

**Outside Temperature** - A NTC sensor is used by the IKE to measure outside temperature for display in the cluster. Other systems that require outside temperature receive this information on the I/K Buses.

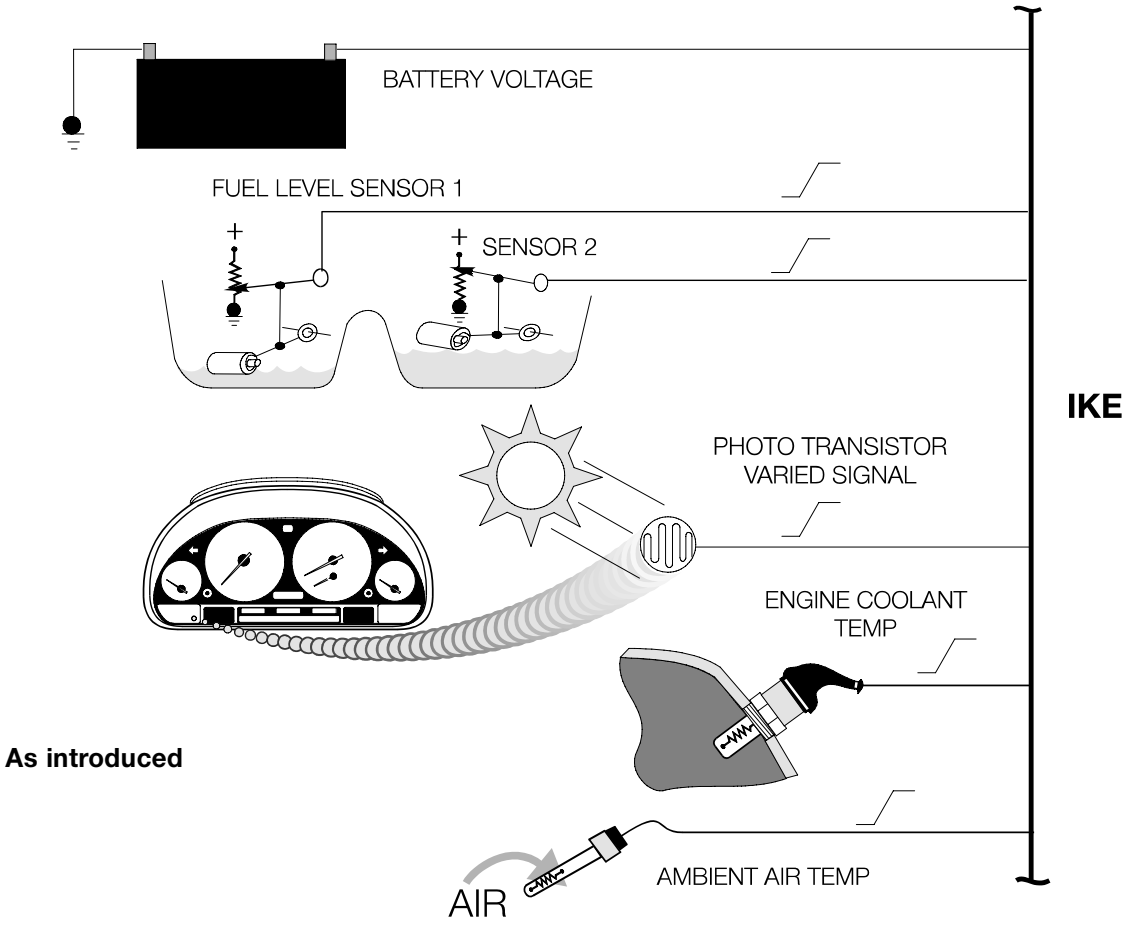

## Digital Input Signals

The normal power-up and KL 50 inputs to the IKE processor:

- Terminal R
- Terminal 15
- Terminal 50

Various functions are dependent on the ignition switch positions.

**Steering column switch** - This switch is used to call up BC functions into the cluster matrix.

**Oil Pressure Switch** - This status is transmitted to the LCM over the I-BUS. The LCM compares the switch status with engine speed to evaluate oil pressure. IKE can store faults with the oil pressure switch and circuit.

**Parking Brake Switch** - Switch status is transmitted to the LCM for evaluation.

**Trip Odometer Reset** - The left button on the cluster is used to reset the trip mileage if the key is on and display mileage if the key is off.

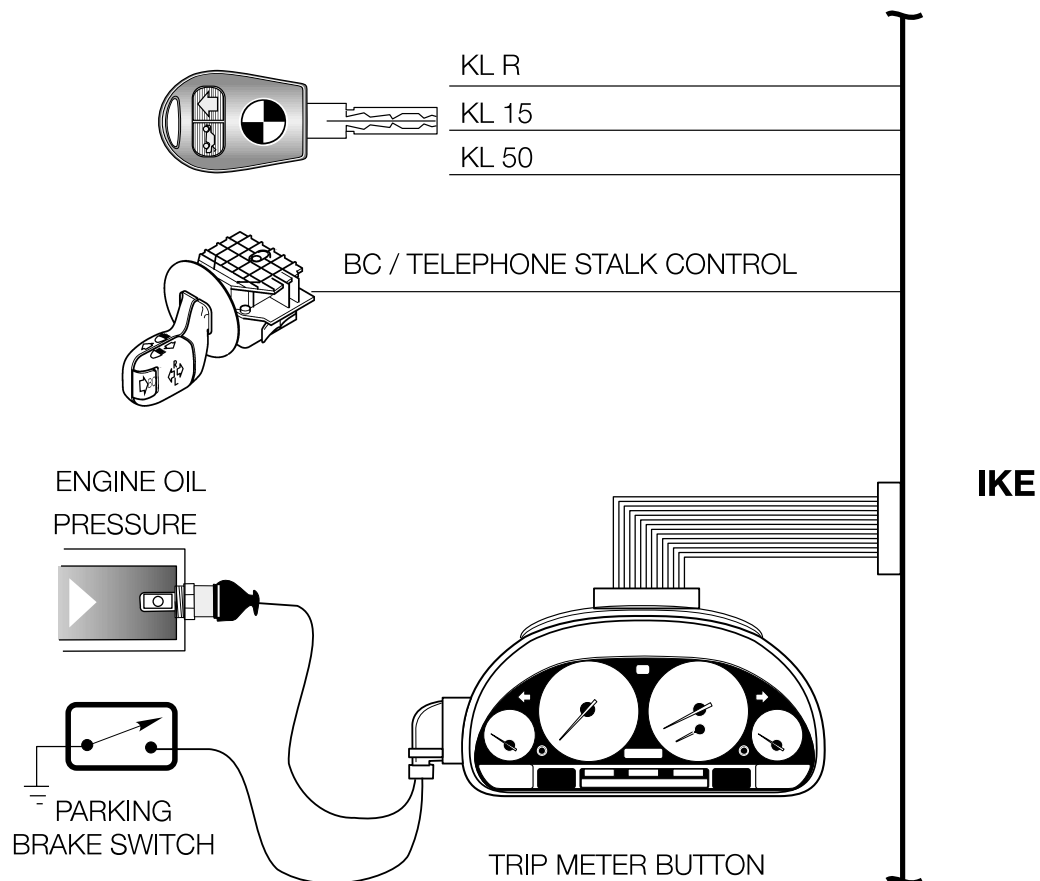

---

## Output Signals

**Speed Signal "A"** - The vehicle speed is made available to control modules that require a precise speed value. The ASC/DSC wheel speed input is reduced by a factor of 5:1 to produce a speed signal "A" that these control modules can process as an input.

### Gong Outputs $T_1, T_2, T_3$

- **$T_1$**  - Activates memo (hourly reminder)
- **$T_2$**  - Activates the tone for the freeze warning
- **$T_3$**  - Activates the tone for check control functions
- **$T_1-T_2$**  - Activated simultaneously produces the tone for code and limit functions.

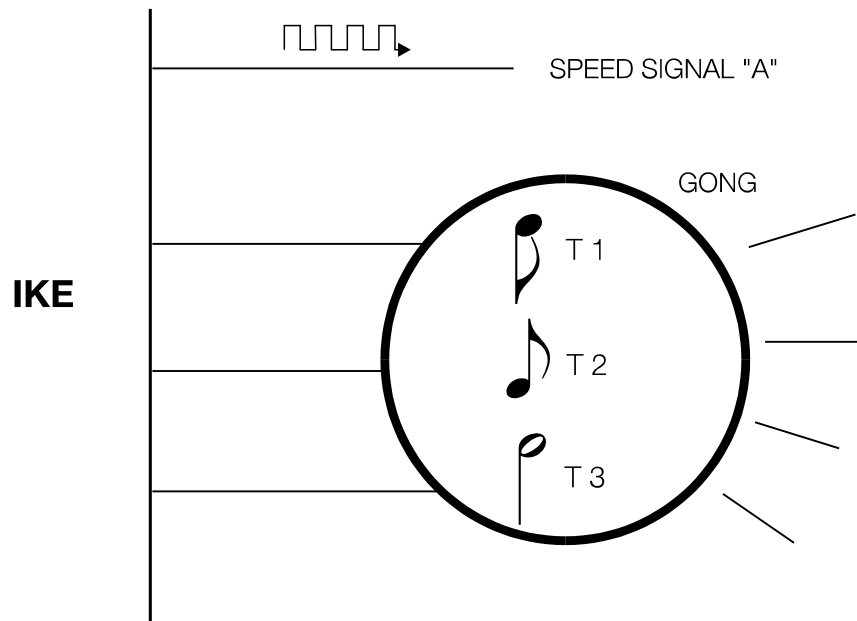

**Buses** - The I/K, D and CAN buses are used by the IKE to transfer data to other control modules as output signals.

## Redundant Data Storage

This specific information is:

- Vehicle ID number
- Total mileage
- Service Interval information

To guard against the loss of specific vehicle information, it is stored in both the IKE and the lamp module (LCM).

This data is compared each time KL15 is switched on. If the data check reveals a mismatch, the manipulation DOT is illuminated.

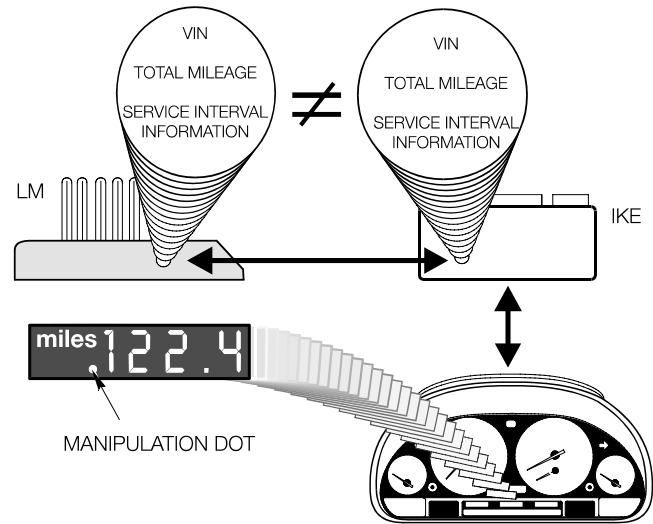

Because of this redundant storage feature, the following points must be noted:

1. If the vehicle ID number is not the same in both modules, the manipulation DOT is activated and there is no data exchange between the IKE and LCM. All functions of both modules will continue to work (car can be test driven).
2. Data is only accepted from the LCM by the IKE if the ID number is the same and the IKE is at 0 miles.
3. The vehicle ID number is input into a module by way of the DIS tester and only accepted if the mileage recorder in the module is at 0 miles.
4. The LCM mileage data can only be over written with a higher mileage and is updated every 60 miles (100 km).
5. If the distance differs by more than 120 miles (200 km) and the ID numbers are the same, the IKE stores a data transfer fault.
6. If the I-Bus link to the LCM faults, the IKE stores this fault and continues to record the mileage driven.

The condition that controls the redundant data exchange and allows only new components to be used as replacement.

If the IKE from another car is used for testing purposes, test driving the car should be avoided if possible. If the vehicle is test driven, the IKE will record mileage and this mileage will be added to total mileage of the original car.

## E38 BC Test Functions

The BC test functions are used to check inputs, outputs and functions of the IKE. There are 21 possible test steps. With the exception of Test #1, #2, and #19, all other tests are locked but can be released through test #19.

The test functions are displayed in the instrument cluster. Test #01 is called up by pressing the CC button for 10 sec. The same activation can be initiated by pressing and holding the CC button while switching on the ignition.

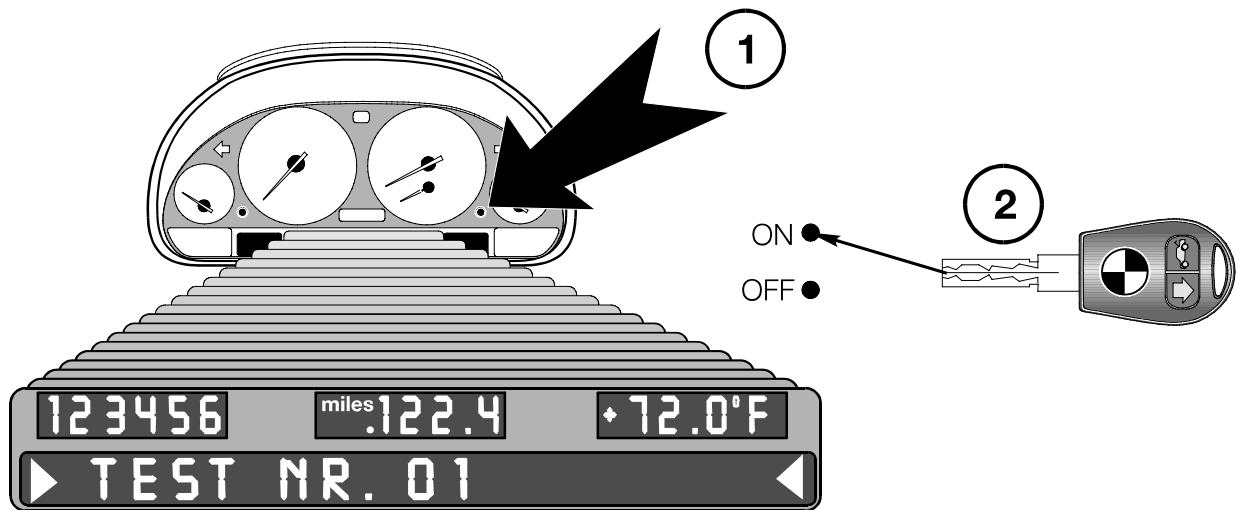

Each time the CC button is pressed, the next test number is displayed.

After selecting a test number, the information from the test is posted by pressing the trip odometer reset button. Several tests have sub-functions which are called up by pressing the reset button while in the test.

### Unlocking test functions:

- Call up test #19 - This is automatically done if attempting to enter a locked test
- Using the trip meter reset button enter by pressing the sum of the last 5 digits of the chassis number, **example:** VIN GB11111, -  $1+1+1+1+1 = 5$ , press the reset button 5 times.
- Confirm entry by pressing the CC button.

The test function can be cancelled by switching the ignition off or pressing the CC button for approximately 2 sec.

---

## TEST NO. 01

The IKE supplies the following data, which appears on the 20 digit cluster matrix display:

- Vehicle Identification number = *FG5TNR: GB11111*
- K value = *K: 4739*
- BMW part number: *BMW TNR. 13809873*
- Encoding, diagnosis and bus index: *CI: 01 DI: 01 BI: 01*
- IKE production date: *DAT: 52/94*
- HW/SW number: *HW: 405W:80*
- Motor: *ZYL:8*  
*M:6 S:400*
- ROM Date: *ROM: 23.08.96*

## TEST NO. 02

The following displays and instruments are activated (system test):

- Speedometer, tachometer, coolant temp gauge, fuel gauge.
- LC displays (segment test)
- Indicators and Warning Lights

This test can only be called up with the vehicle at a standstill, engine turned off, with KL R or 15 switched on.

## TEST NO. 03

The following SI data can be displayed:

- SI km since last reset: *SI KM: 1250*
- SI automatic transmission kilometers: *SI-GETR - KM 23300*

---

## TEST NO. 04

Momentary Fuel Consumption is displayed:

- VBR: 0.0 L/100KM  
VBR: 0.0 L/H

## TEST NO .05

This function shows the range calculation data:

- Range at measured fuel consumption: RW-VBR: 19.5 L/100 KM

## TEST NO .06

In this function, the fuel tank volume for the right and left half of the fuel tank and the current total tank volume are shown in the Instrument Cluster matrix display.

This enables the function of the float level sensors to be checked.

Display: *TNK 29.5/34.2/63.7L*  
*TNKAMZ 60.2L PHASE 1*

The first numerical value in line 1 shows the contents of the left half of the fuel tank, the second, the volume of the right half of the tank. The third value is the current total value. If a level sensor is defective, it's value reverts to 0.

Line 2 shows the current average value (displayed value) for the contents of the fuel tank. The numerical value after the word phase refers to the valid computed number.

Phase 1: Regular computing method by way of sensors (both sensors OK).

Phase 2: Calculation in progress from TKVA signal (sensor faulted)

Phase 3: Fuel tank contents cannot be computed, fuel gauge reads 0 (at least one sensor is faulted).

## TEST NO. 07

Momentary coolant temperature. *KTMP: 076° C*

Momentary engine speed: *N:5238 U/MIN*

---

## TEST NO. 08

Momentary Road Speed V: *085 KM/H*

## TEST NO. 09

Battery voltage (terminal 30) *UB: 12.5 V*

## TEST NO. 10

Preset national market codes list. The number is encoded in the IKE with the central code key

Display: *USA 02*

## TEST NO 11

The unit code is entered in the EEPROM by the DIS after IKE has been installed and can be read out by means of test function 11.

## TEST NO. 12

This test function shows the data for computing the vehicle's estimated time of arrival.

- Average speed for calculating arrival time: *VANK: 029.7 KM/H*
- Current arrival time: *ANK: 13.04*

## TEST NO. 13

This test function enables the gong to be tested, Display: *GONG?*

- After confirming by pressing the trip odometer reset button, the four audible warning signals are triggered off once in succession.
- Gong T1 (Memo signal) 2.0s
- Gong T2 (Outside temperature) 1.5 s.
- Gongs T1 and T2 (LIMIT/CODE warning) 1.5 s
- Gong T3 (Check Control Gong)



---

## TEST NO. 14

This function shows the contents of the fault memory in a hexadecimal code.

Display: *DIAG: 07 81 033*

## TEST NO. 15

Not assigned to any test function.

## TEST NO. 19

Procedure for unlocking the BC test functions. See page 32.

## TEST NO. 20

BC consumption value correction factor. This test adjusts the correction factor for the consumption value displayed in the MID. The production line installed value is 1000. The value ranges from 750 to 1250.

To adjust the correction factor press the trip meter reset button once for a reduction of 1. For each press of the reset button the value decreases by 1 until it reaches 750. After 750 the number will reset to 1250 and begin to count down again.

To accept the set correction factor press the CC button.

The consumption correction factor (VK) is calculated from the actual amount of consumed fuel (VBR IST) and the displayed value (VBR ANZ):

$$VK = (\text{Actual MPG} / \text{Displayed MPG}) \times 1000.$$

## TEST NO. 21:

This function resets the software at the IKE. This reset is necessary after replacing for example one of the fuel tank level sensors. Otherwise the damping function in the software will prevent the actual value from being shown only after a long time duration.

Display: *RESET ?*

If the test is terminated without a software reset, the ignition switch must be turned back to "0" or the CC button pressed.

---

## **CHECK CONTROL MODULE**

**Model: E38**

**Production Date: E38: From start of production to 9/95.**

### **Objectives:**

After completing this module you should be able to:

- Recognize how different priority messages are displayed.
- Identify the different methods used to recall CC messages.
- Understand the operation of the electronic oil level sensor.

## Check Control Module (E38 start of production up to 9/95)

The Check Control System in early E38 models utilizes a self-contained Check Control Module (CCM).

The CCM is located in the electrical carrier in front of the glove box.

This module collects and evaluates all check control data, including messages from the Lamp Control Module (LM).

When the driver needs to be informed of a problem, the CCM signals the IKE over the I-BUS. The IKE will then post the message in the instrument cluster matrix display.

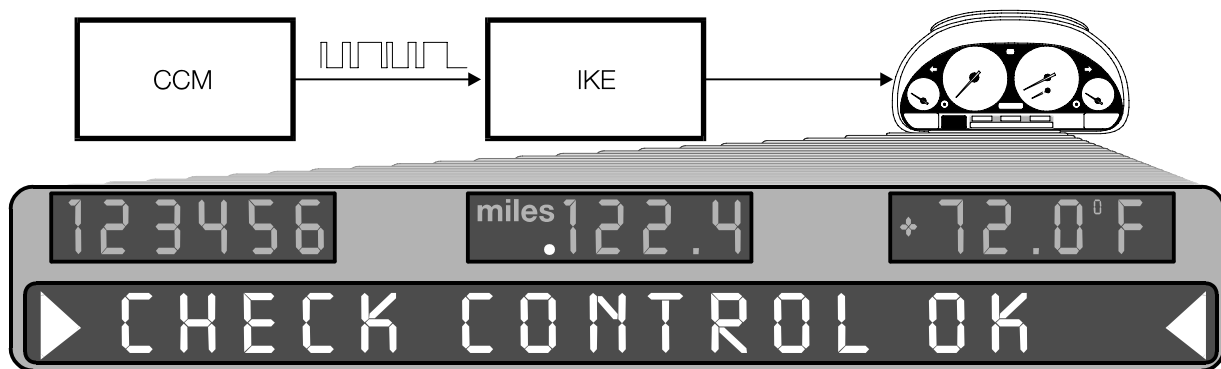
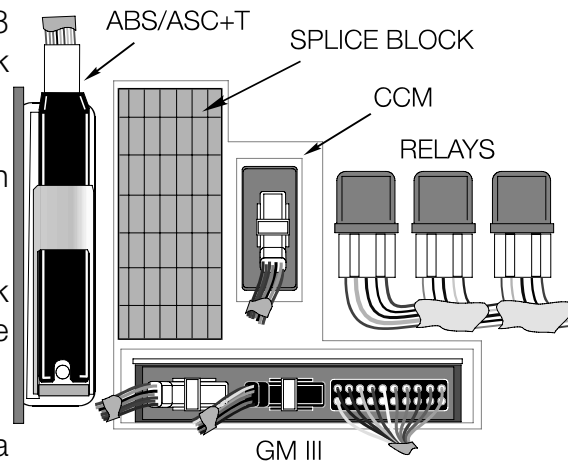

The text and operation of the E38 check control was changed to improve message interpretation and reliability, for example:

- **GONG.** Pre E38: Gong with every new display.  
E38: Only activated for first display in group.  
**Advantage:** Reduces driver's irritation.
- **DISPLAY:** Pre E38: "Owner's Handbook" used repeatedly  
E38: "Owner's Handbook" phrase deleted. Actual text for situation with recommended action.

**Advantage:** Driver can assess situation without reading the Owner's Manual.

All the warning messages fall into one of four priority groups.

**Priority Group P1** - Faults that directly affect the safety or operation of the car and the drive should be addressed immediately. The text is displayed with a flashing arrow on the right and left sides.



**Priority Group P2** - Faults that do not affect vehicle's safety or operation directly and the driver need not respond to immediately. These messages are displayed only once when the fault occurs and have to be called up again with the CC button.



**Priority Group P3** - These faults are shown when the key is turned on before a trip. The faults in P3 are mainly fluid levels which are not assigned to P2. The lights on reminder is a Priority 3 item. With the key in position 0 with the light switch On initiates this reminder.



**Special warnings** - These are top priority messages and won't be overridden when displayed. Seat belt/ignition key in lock with door open are some of these messages.

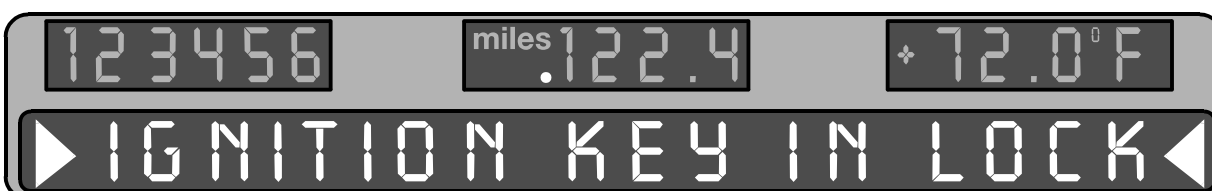

When the key is switched off, all registered check control faults are displayed.

The language of the check control messages is set with the central coding key.

## CC DISPLAY PROCEDURES

**Special Displays** - These messages will overwrite all other displays. If more than one special display request is received by the CCM, the one with the highest priority will be delivered.

**P1 Group** - P1 displays remain posted as long as the fault is present. If several P1 warnings have been received by the CCM, they are displayed one after another in 3 second intervals.

**P2 and P3 Groups** - The messages in both groups are displayed when KL15 is switched on for a maximum of twenty three (23) seconds and P3 messages are not displayed after the trip is started. P2 and P3 warning that have been registered by the CCM can be recalled during the trip by pressing the CC button.

**Reminder Symbol “> <”** - The “+” symbol is no longer used. If more than one P1 check control message is present, the reminder symbol “> <” is illuminated permanently. If a P2 or P3 message is extinguished, the reminder symbol informs the driver that a CC message has been posted. The symbol will flash when a new P1 warning is recognized.

**CC Button** - Check control messages can be recalled, for up to 3 minutes, after the ignition is switched off using the CC button.

The highest priority message is displayed first with following messages in a priority descending order. After the lowest message has been displayed, pressing the CC button will clear the matrix.

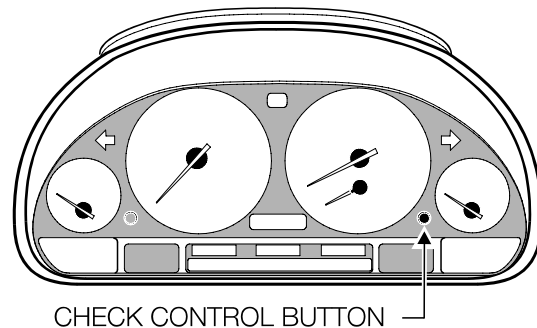







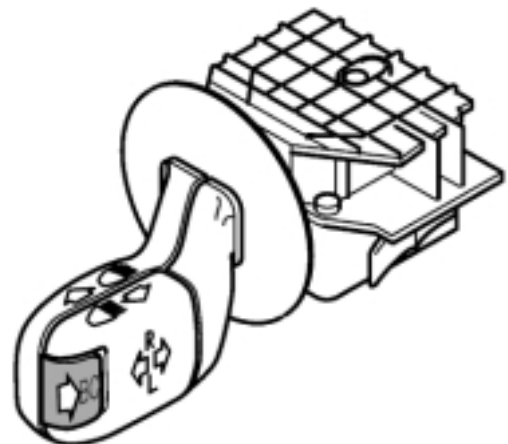



“Check Control OK” is posted when the CC button is pressed and there are no warning message present.

**Steering column switch (LSS)** - Pressing the steering column switch will clear the matrix display if low priority messages are being posted. This will allow the display to be utilized for other information.

**Gong** - The warning gong is activated by the IKE when the CCM sends the proper data over the I Bus. The gong is activated only when higher priority warnings are posted.



CCM DISPLAY	GONG	PRTY	SCOPE OF MONITOR
<b>OPERATING CONDITIONS</b>			
Release Parking Brake		P1	Warning displayed above 3 MPH
Door open with ignition key in position KL 15		P2	Warning displayed when a door is open or opened above 3 MPH.
Trunk Open		P2	Warning displayed above 3 MPH when trunk opens or was left open prior to pulling away. Displayed once only.
Stop! Engine oil pressure		P1	Warning displayed oil pressure has fallen below safe level.
Coolant Temperature		P1	Warning displayed when coolant rises above maximum temperature
Check Brake Lights		P2	The LM monitors certain vehicle lights and circuits. When a fault is detected the CCM is notified to post a display.
Check low-beam headlights			
Check high-beam headlights			
Check parking lights			
Check front fog lights			
Check license plate lights			
Check brake pads		P2	Warning issued when brake pad wear limit is reached.
Lights on?		P3	Warning displayed when key is in position 0 if driver's door is opened with light switch on.
Ignition key in lock		S	Warning is displayed when key is left in ignition switch in position R or 0.
Please Fasten Seatbelt		S	Warning is displayed for a 6 second period after "Ignition on" with seatbelt fastened or not. If seatbelt is fastened the intermittent gong is switched off.
Remote Battery		S	When remote key battery voltage drops below 4.5 volts
<b>FLUID LEVELS</b>			
Check Brake Fluid		P1	Warning is displayed when brake fluid is too low.
Check engine oil level		P2	Warning is displayed when the engine oil level is too low. The E38 is equipped with a new electronic oil level sensor. ( see E38 Complete Vehicle for function and operational description).
Check coolant level		P2	Warning is displayed when coolant level is too low. The warning is only posted when the ignition key is first turned on.
Add washer fluid		P2	Warning is displayed when washer fluid level is low. This warning is displayed at any time the level becomes low to provide an early warning
NOTE: The fluid level warnings are monitored in 25 second intervals. This time interval prevents false displays from occurring due to bumpy roads, fluid sloshing, etc.			
<b>CONTROL SYSTEM FAULT DISPLAYS</b>			
Emergency transmission operating program		P2	If a fault occurs in the AGS control system Check control displays the message. The message is originated from the AGS CM to IKE over a one way serial data line. From there IKE notifies the CCM over the I Bus.
EEPROM IKE		S	When IKE and LM data differ (for testing purposes).

## Electronic Engine Oil level Sensor

The E38 began production utilizing the electronic oil level sensor, it was later phased into production on other models and engines.

The electronic level sensor is located in the engine sump mounted to the engine oil pan.

The oil level sensor contains an integral micro-processor and two sensing elements. The sensing elements are inside of a plastic shield and are immersed in the oil.

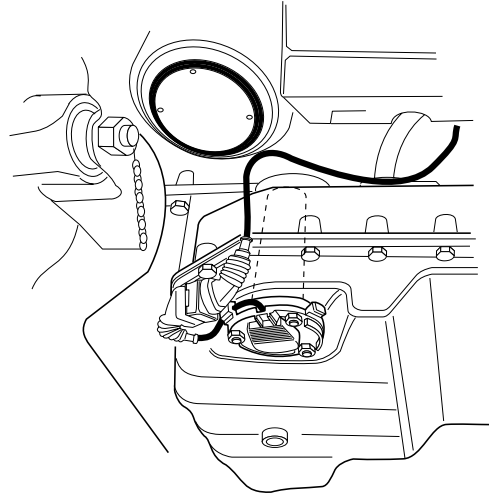

- One element measures the oil temperature.
- The second is heated to 10°C above the temperature of the oil and then switched off to cool .

The length of time it takes to cool the heated element is how the sensor determines the engine oil level. When the oil level is high it covers a larger portion of the probe submersed in the oil sump. The engine oil around the probe cools the heated element faster than if the level is low.

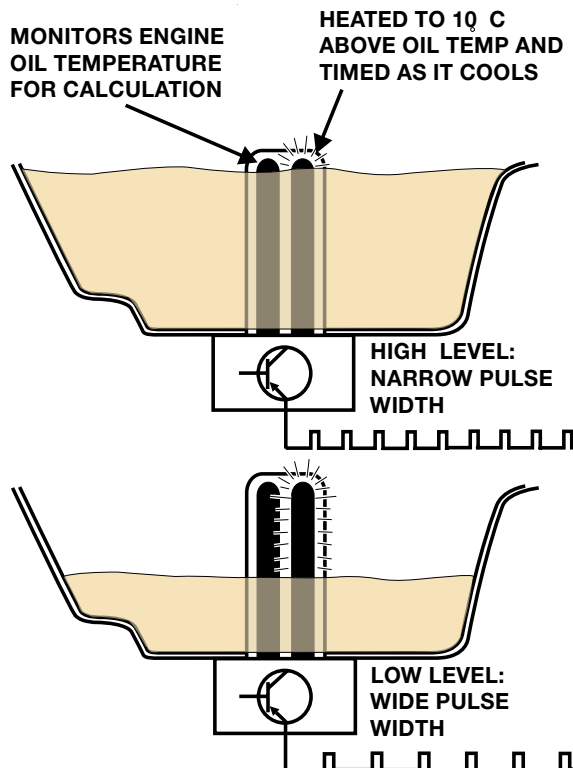

The micro-processor in the base of the sensor supplies a signal to the CCM/LCM with a varying pulse width and frequency.

The “high” or “on” time of the signal is dependent on oil temperature, this means the hotter the oil is, the longer the sensing element has to be heated to reach 10°C above.

The “low” or “off” time of the signal is dependent on the oil level. The lower the oil level is, the longer the “off” time of the signal is.

Cool down times are averaged over a minimum of 350 measurements to take account of slosh in the oil pan while driving. If the average is over the warning limit the low oil warning is set.

**Please refer to S.I. 11 09 00 for a table of the warning levels of individual vehicles.**

---

## **BASE INSTRUMENT CLUSTER (KOMBI)**

**Model: E39, E53**

**Production Date: From start of production**

### **Objectives**

After completing this module you should be able to:

- Describe how the various input signals for the Check Control system arrive at the KOMBI.
- Explain what information is used to calculate the Service Interval.
- Know how to perform the instrument cluster self-test.



## Base Instrument Cluster

The base instrument cluster consists of five analog gauges. The processing electronics and drivers for the gauges are contained in the cluster. The five gauges include:

- Fuel Gauge
- Speedometer
- Tachometer
- Fuel Economy Gauge
- Coolant Temperature



Three Liquid Crystal Display blocks are provided for the:

- Check Control Display - pictogram
- Mileage, Outside Temperature and BC Display
- Transmission Range and SI Display

Warning lamps and indicators are positioned to the left and right of the display blocks. The number of warning lamps is greater on the base cluster for the display of several check control warnings. All of the warning lamps and indicators are LEDs and not replaceable. Critical warning lamps use two LEDs for a safety margin.

There are replaceable lamps for the back lighting on the liquid crystal display units.

The **LEFT DISPLAY BLOCK** contains a pictogram for various check control warnings. LEDs within the display will illuminate for:

- Lighting failures for headlight (low beam), taillight and brake lights.
- Open doors or trunk
- Low washer fluid

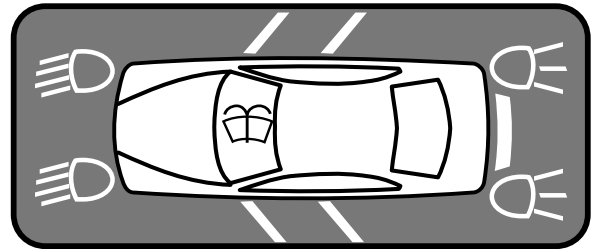

Additional circuits monitored by check control include the engine oil level and transmission emergency program. These warnings are indicated by lamps positioned in both indicator display areas on the left and right sides on the bottom of the instrument cluster.

Due to the ability to illuminate multiple warning LEDs, there is no priority displays for the pictogram check control. If multiple faults exist, each corresponding LED will illuminate.

The LED will remain illuminated as long as the fault exists. The only exception is the washer fluid which will go out 60 seconds after KL 15 is switched ON.

All check control and lamp control circuits are monitored by the Light Check Module (LCM). When failures or faults exist, the messages are passed to the cluster for display over the K-Bus.

The **MIDDLE BLOCK** contains the displays for the Total Mileage, Trip Mileage and Board Computer.

The total mileage is stored in non-volatile memories in the cluster EEPROM and the LCM.

The mileage can be displayed with the key off for 25 seconds if the mileage reset button is pressed.



Board Computer information can be displayed by pressing the turn signal lever.

The **RIGHT BLOCK** contains the displays for the automatic transmission driving range and the Service Interval Indicator III.

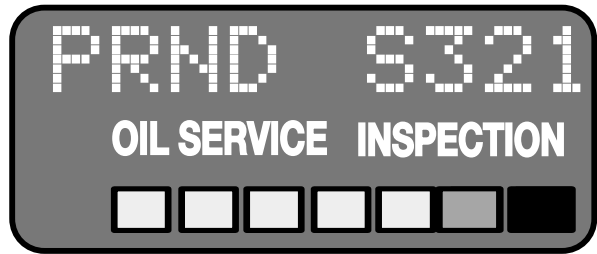

The display of the Service Indicator on the E39 is the same as the “High” clusters. The processor for the intervals is located in the cluster electronics. The processing method for determining interval times uses the Service Interval III system. Interval times are based on fuel consumption instead of mileage and starts. This system was introduced on the 1996 E38 - 750iL .

Using fuel consumption offers several advantages over the SIA II method for determining oil service.

- First, the processing electronics are less involved in that only one value is needed for the processing.
- Second, the use of fuel consumption is a more accurate method of determining engine load and the need for service.
- Third, resetting of the indicator before the scheduled time will not effect the time to the next service.

A set volume of fuel (in liters) is stored in the EEPROM of the SI. The volume of fuel is dependent on the vehicle and engine size. The processor receives the “ti” signal as the vehicle is used. As 20% of the stored volume is consumed, one of the green LEDs will go out. Each successive 20% of fuel consumption will cause the next LED to go out until 100% of the stored volume has been consumed. At this point the yellow LED will come on indicating the service is due. At 108% of the volume, the RED LED will illuminate indicating an over due service.

With each reset (oil service ore inspection), the total volume of fuel is restored in the EEPROM and the calculation starts over again.

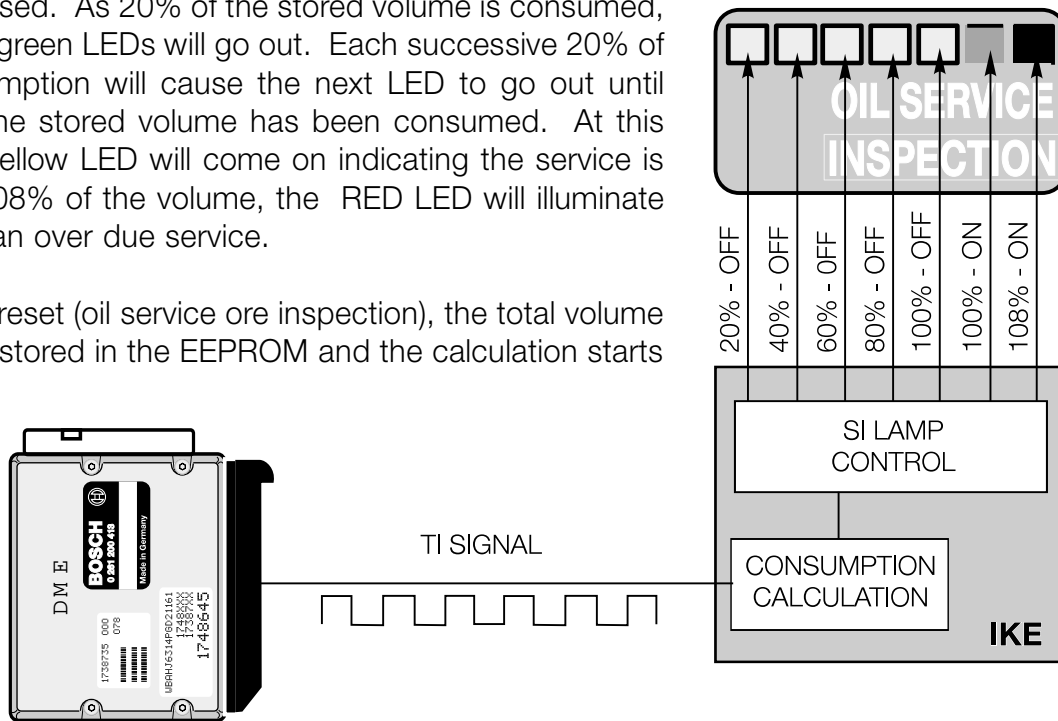

## Dynamic Digital Inputs

**Distance Signal-** This input is supplied to the cluster by the ASC/DSC control module as a square wave signal. Pulses from the left rear wheel speed sensor are processed by the DSC module to produce this signal. The cluster electronics process the input for the cluster display and pass the signal along on the K bus as speed signal “A” for other control modules requiring the vehicle speed signal.

**Engine Control Module Signals -** The “Ti” & “TD” signals are produced by the Engine control module and sent to the cluster. As first introduced on the E39, these signals were delivered to the cluster via hard wire. On models produced after 9/98 these signals are delivered by the CAN Bus.

The cluster processes the signals for the tachometer and fuel economy indicator displays. The Ti signal is used by the cluster for the SI indicator. The cluster also passes the TD signal out over the K Bus.

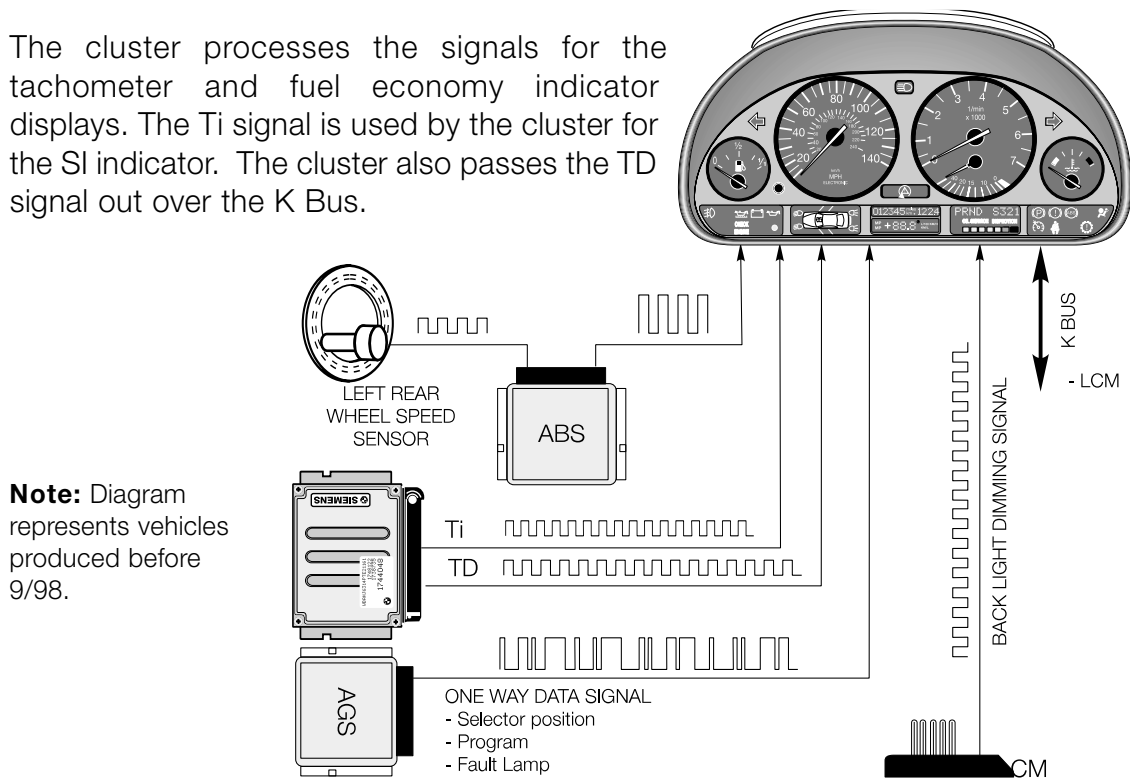

**Note:** Diagram represents vehicles produced before 9/98.

**Transmission One Way Data Signal-** The AGS control module provides a one way data signal to the instrument cluster for signalling of the range selector position, driving program and for fault lamp activation. This signal is provided over the CAN Bus on vehicles produced after 9/98.

**DIMMER SIGNAL -** This is a pulse-width modulated signal from the LCM. It is used to control the intensity of the back lighting of the instruments and the LCDs when the lights are switched ON. This signal is also output over the K-Bus.

**K-BUS Signalling -** The Cluster receives signals for the Check Control Pictogram over the K-Bus.

## Analog Input Signals

**Battery Voltage** - Battery voltage is monitored by the cluster and a fault is stored if the voltage exceeds 16 volts.

**Fuel Tank Level** - Two lever action sensors are wired in parallel to the cluster. The two varying voltage signals are processed by the cluster for fuel gauge and low fuel warning display.

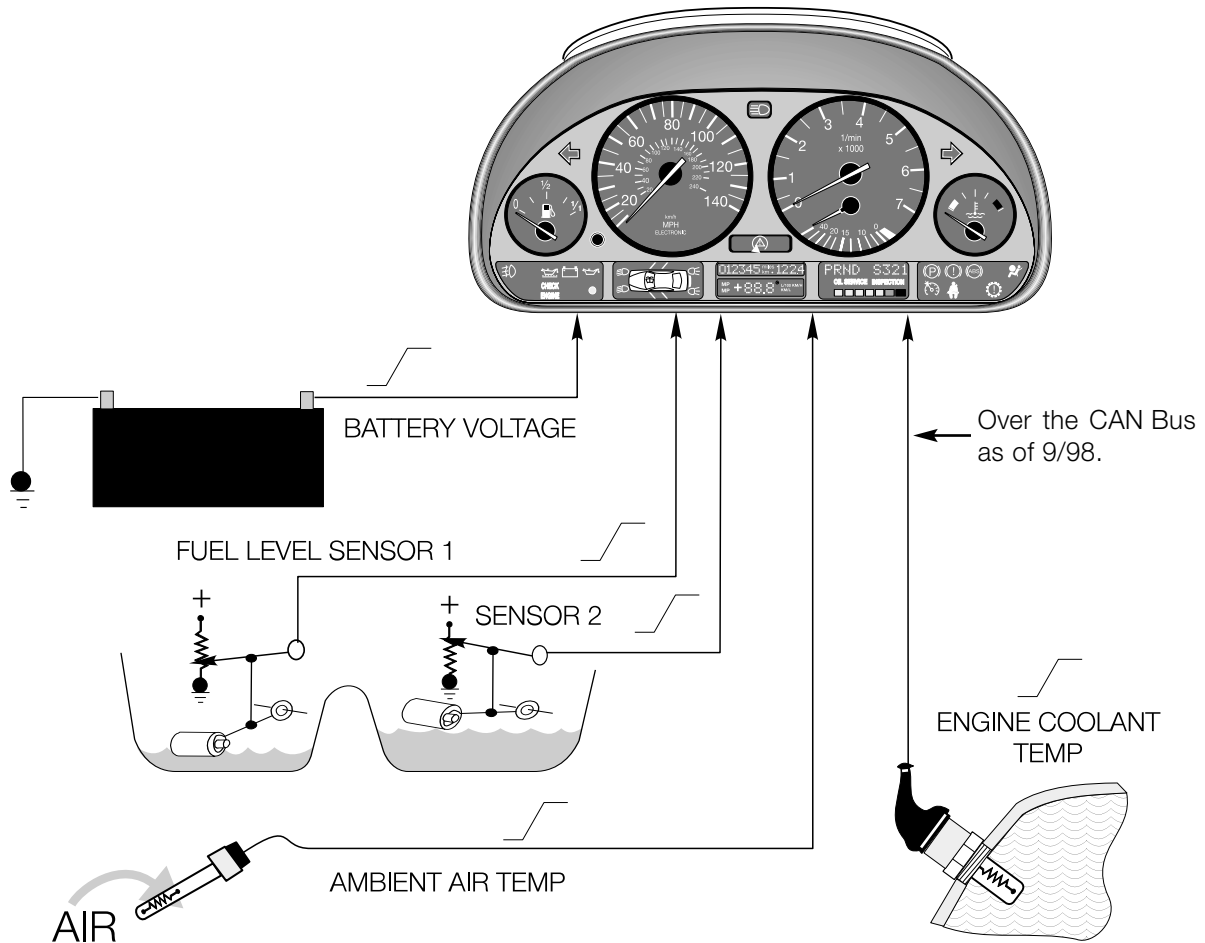

**Coolant Temperature** - A NTC sensor is used to measure coolant temperature. the cluster uses this input for temperature gauge display. This is also a CAN bus signal on vehicles which have the CAN bus link to the cluster

**Outside Temperature** - A NTC sensor is used to measure the ambient temperature. The signal is processed by the cluster and passed out over the K Bus to modules requiring this input for processing.

## Digital Input Signals

The normal ignition switch terminals (**KL R**, **KL15** & **KL50**) are input to the cluster. Various functions are dependent on ignition switch position.

**Steering Column Switch** - The turn signal stalk provides a momentary ground signal that is used to call up BC functions.

**Brake Pad wear Sensor** - The pad sensor inputs are used to illuminate the brake pad warning indicator.

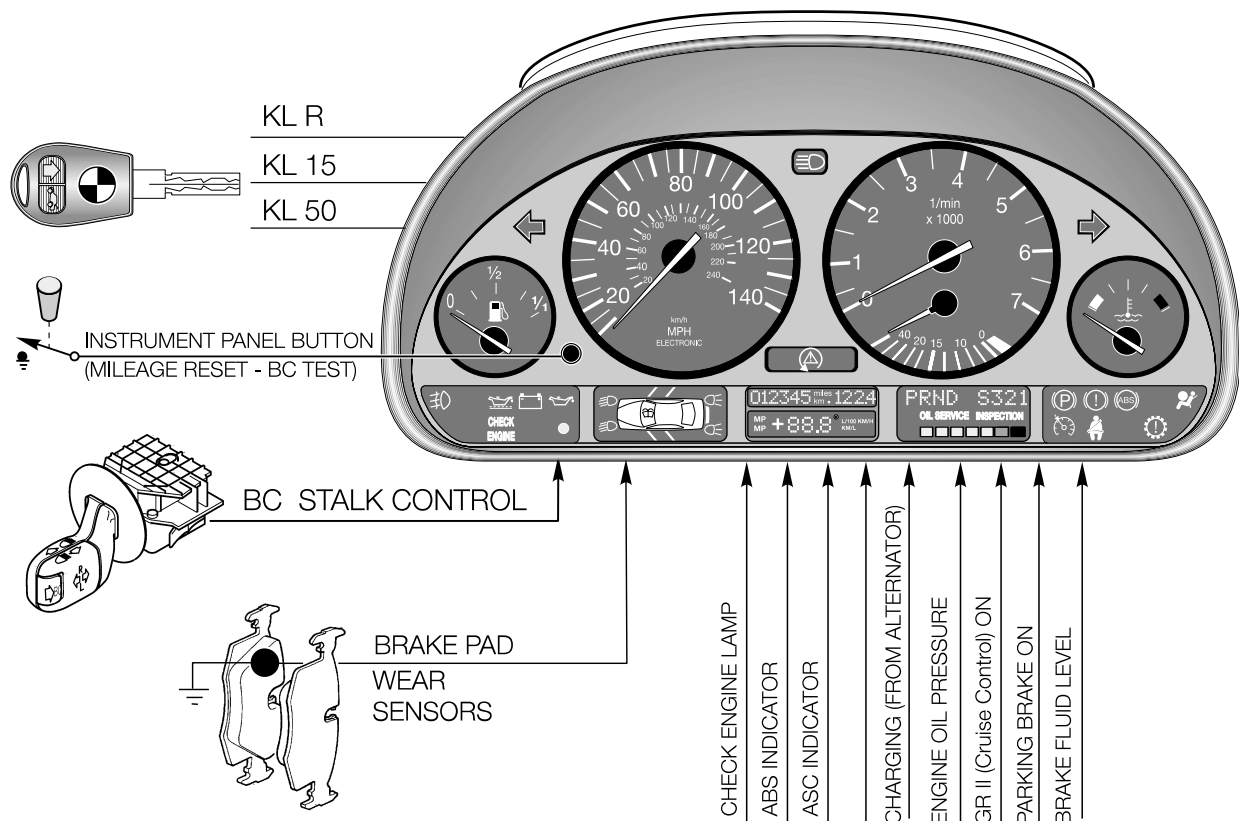

**Instrument Panel Button** - The reset button is used to reset the trip - odometer as in the past. It will also display the mileage, if pressed with the key switched OFF. This button is also used for the Base BC/instrument cluster test functions.

**Inputs for Warning Lamps** - Various switches are used to signal the cluster for warning and indicator lamp illumination. Many of these inputs are provided over the CAN or K-bus.

# Output Signals

**Speed Signal "A"** - The vehicle speed signal is available as an output for control modules that require precise vehicle speed information.

**K-Bus Interface** - The K Bus is used to transfer data between the cluster and other modules on the link. The diagnostic interface also passes over the K Bus for troubleshooting with the DIS.

**Low Fuel** - Based on the processing for the low fuel indicator lamp, this output is also sent to the Engine control module. The signal is stored along with a mis-fire detection fault for troubleshooting purposes.

**Gong Output** - T3, The T3 tone is used for check control warnings.

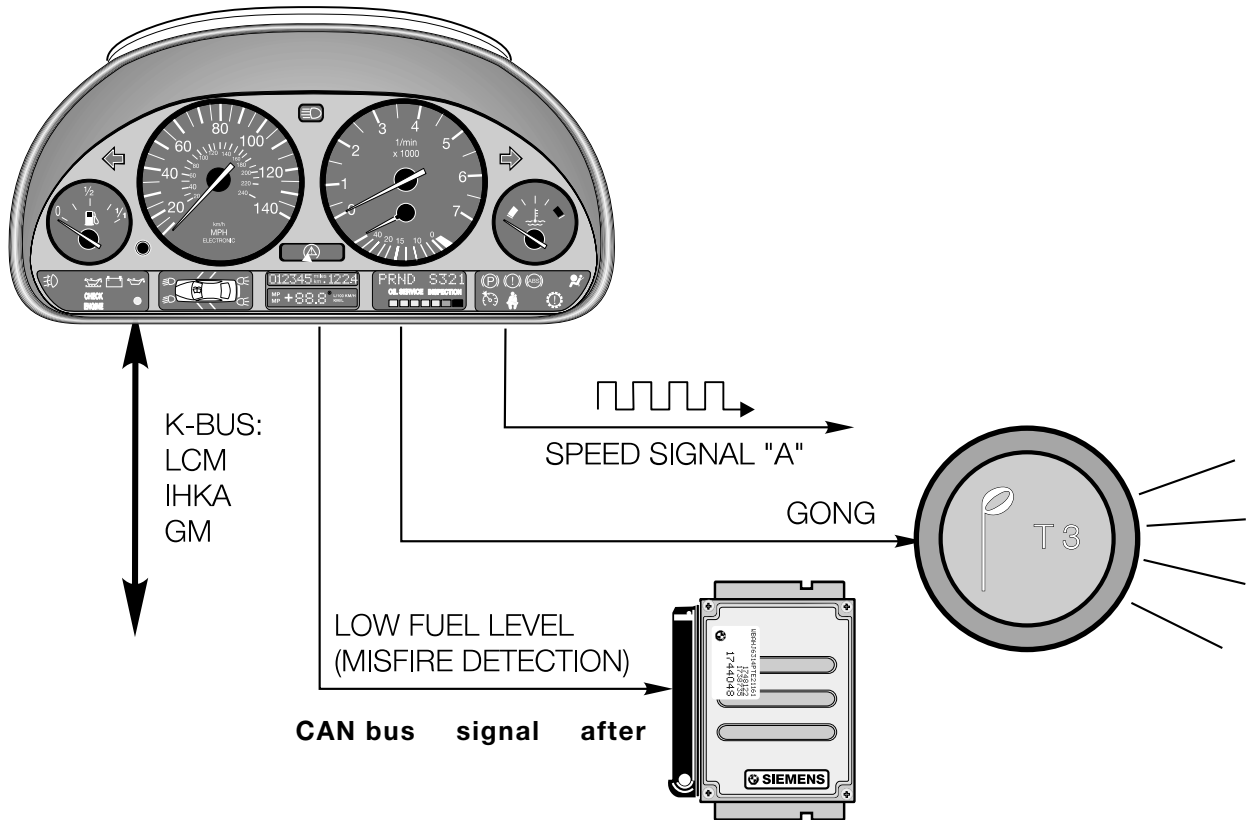

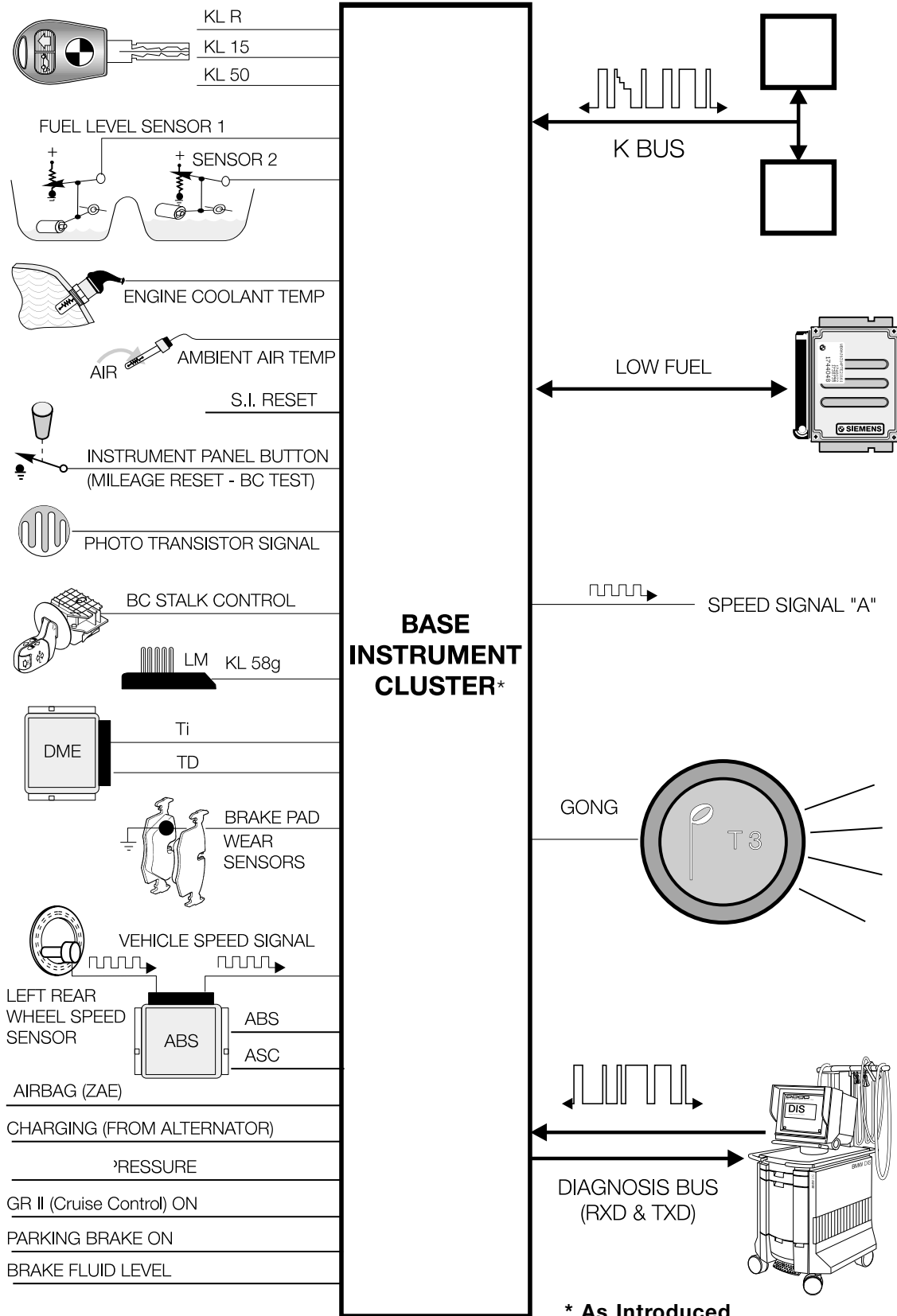



## Redundant Data Storage

The specific information stored redundantly includes:

- Vehicle ID number
- Total mileage
- Service Interval data

The data is stored in the cluster and in the Light Check Module (LCM). The storage of this data follows the redundant storage of the IKE. It prevents the loss of total mileage or SI data in the event of a cluster processor failure.

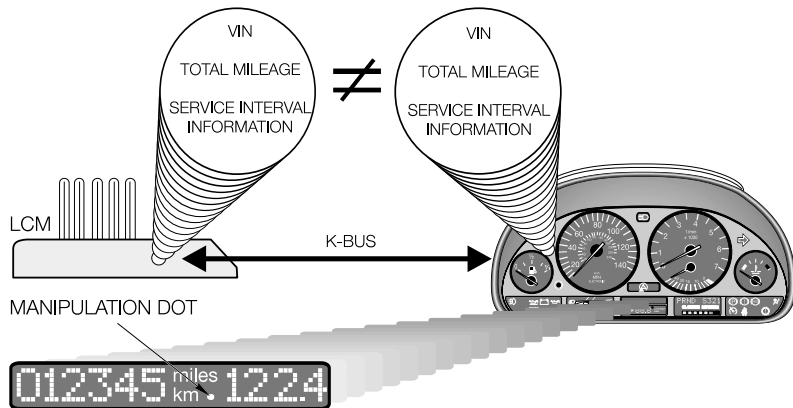

The data is compared each time KL 15 is switched ON. If the data does not match, the manipulation DOT in the mileage display is illuminated.

Because of this redundant storage feature, the following points must be noted:

1. If the vehicle ID number is not the same in both modules, the manipulation DOT is illuminated and no data transfer takes place. All functions of both modules will continue to operate.
2. Data will only be accepted by the cluster from the LCM if the ID numbers match and the cluster mileage is zero.
3. The vehicle ID number is input into the cluster through coding and will only be accepted when the cluster is at zero mileage.
4. The LCM stored mileage can only be overwritten with a higher mileage and is updated every 60 miles.
5. If the mileage differs by more than 120, and the ID numbers are the same, the cluster will continue recording the mileage and set a fault for data transfer.
6. If the K Bus link to the LCM fails, the cluster will continue to record mileage and store a fault for the data link.

These conditions will only allow new components to be installed for replacement purposes. However, a used component can be installed for testing purposes. If a cluster from another vehicle is used for testing purposes, road testing of the vehicle should be avoided, because the cluster will accumulate mileage.

## Base version On-Board Computer

The On Board computer information on the base variant cluster can only be displayed in the center matrix. The following information can be displayed:

• **OUTSIDE TEMPERATURE**



• **FUEL CONSUMPTION**



• **AVERAGE SPEED**

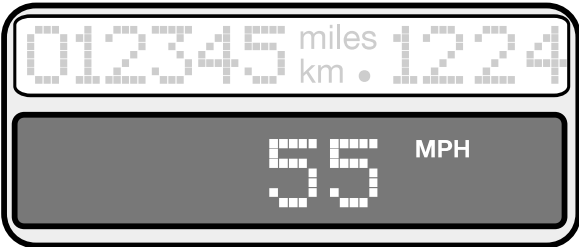

• **ESTIMATED DRIVING RANGE ON REMAINING FUEL**

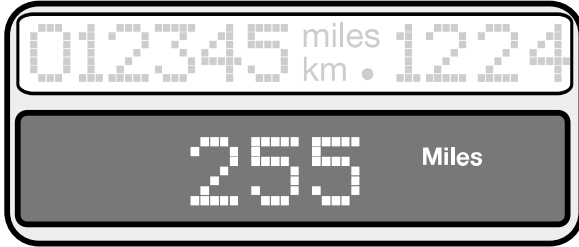

On 97 M.Y. vehicles, when KL R is switched ON, the outside temperature will be displayed. To call up any other function, the turn signal lever must be pressed and released. The other functions are than displayed one after the other. A blank field is provided after the average speed display to allow the driver to switch off the display. Vehicles produced from M.Y. 98 the display last called up will be remembered and displayed when KLR is switched back on.

A freeze warning is incorporated in the BC. If the temperature drops below 37°F, the gong will sound and the temperature display will flash in the BC. Pressing the turn signal lever will cancel the display.

Two of the displays “Average Fuel Consumption” and “Average Speed” can be reset to start new calculations. To reset the displays, press and hold the turn signal lever, for longer than one second, when the function is called up. The BC will than start to compute a new average value.

## Base BC/Instrument Cluster Test Functions

In addition to the fault memory and diagnostic link, the base instrument cluster contains a series of test functions that can be accessed to check various functions and values. The test functions are displayed in the mileage LCD block. There are a total of 21 test functions. The test functions are similar to those of previous Board computers and contain similar tests.

- Tests 1 & 2 are always unlocked.
- Tests 3 -21 are only accessible after unlocking the test function. Test 19 is the unlock function for accessing the displays.

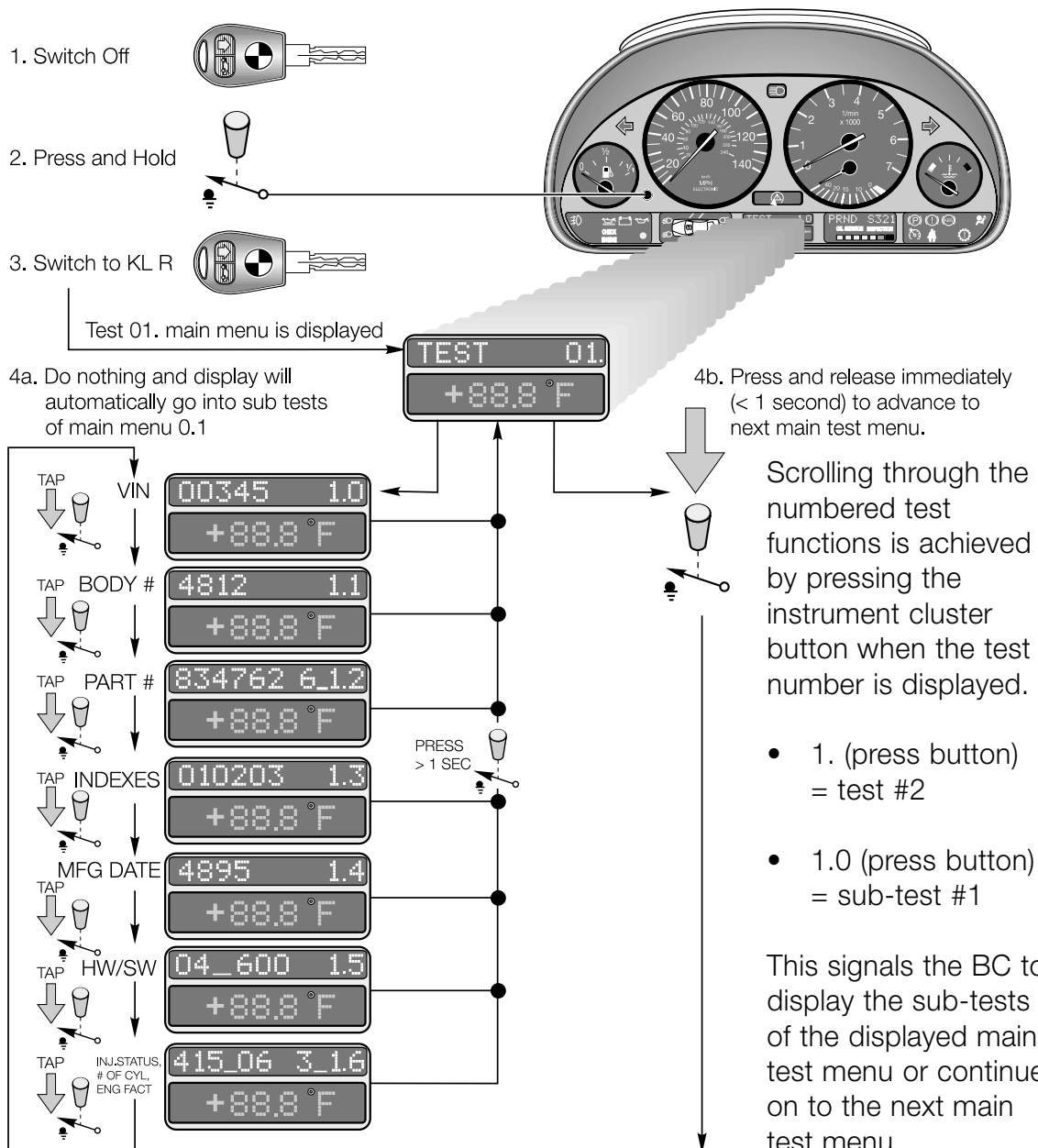

---

**TEST 01.** - Vehicle specific data including:

**SubTests:**

- 12345 1.0** = VIN
- 4812 1.1** = K-value
- 834762 6\_1.2** = Part number of cluster
- 010203 1.3** = Coding/Diagnosis/Bus index
- 3495 1.4** = Manufacturing date (calendar week/year)
- 04\_600 1.5** = Hardware/software # of cluster (HW:04, SW:6.00)
- 415\_06 3\_1.6** = Injection status, number of cylinders, engine factor

**TEST 02.** - Cluster System Test - activates the gauge drivers, indicators and LEDs to confirm function.

**TEST 03.** - SI data

**Sub Tests:**

- 1500 3.0** = Liters
- 0 3.1** = Periodic inspection days (not applicable for US).

**TEST 04.** - Momentary Consumption

**Sub Tests:**

- 0267 4.0** = 26.7 liters/1000km
- 0073 4.1** = 7.3 liters per hour

**TEST 05.** - Distance Gone Consumption

**Sub Tests:**

- 0195 5.0** = 19.5 liters/100 km
- 226 5.1** = momentary distance to go (226km)

**TEST 06.** - Fuel level sensor inputs in liters

**Sub Tests:**

- 237415 6.0** = Fuel level averaged
  - LH sensor input = 23.7 liters
  - RH sensor Input = 41.5 liters
- 0652 6.1** = Total tank level averaged = 65.2 liters
- 0667 1\_6.2** = Indicated value and tank phase
  - 1 = both sensors OK
  - 2 = one sensor fault
  - 3 = implausible input

---

**TEST 07.** - Temperature and Speed

**Sub Tests:**

**032**    **7.0**    = Coolant temp input 32°C  
**245**    **7.1**    = Outside temp input 24.5°C  
**5283**   **7.2**    = Engine speed 5,283 RPM  
**058**    **7.3**    = Vehicle speed 58km/H

**TEST 08.** - Input values in HEX form

**Sub Tests:**

**XXX**    **8.0 - 8.3** = Hex code, Instrument cluster inputs

**TEST 09.** - Battery voltage

**Sub Test:**

**125**    **9.0**    = 12.5 volts

**TEST 10.** - Country Coding

**Sub Test:**

**02**    **10.0** = US 02

**TEST 11.** - Cluster code

**Sub Test:**

**000003** **11.0** = Cluster code

**TEST 12.** - Not used

**TEST 13.** - GONG test

**Sub Test:**

**Gong**    **13.0** = Activate gong by pressing button (gong response is delayed).

**TEST 14.** - Fault memory (not for diagnosis)

**TEST 15 to 18** - Not used

