

---

# Table of Contents

## Engine Diagnosis

Subject	Page
<b>Engine Diagnosis</b> .....	<b>3</b>
Compression Testing .....	5
Cylinder Leakage Testing .....	6
Workshop Hints on Cylinder Leakage Testing .....	7
Cylinder Arrangement and Firing Order .....	8
Ignition System Diagnosis .....	9
Fuel System Testing .....	12
Fuel Volume Testing .....	16
Residual Pressure .....	17
Engine Adaptation Values .....	20
Engine Misfire Diagnosis .....	22
Smooth Running Measurement .....	25
Valvetronic N62 .....	26
N62 Engine Testing .....	28
MKA Adapter .....	28
Compression Test N62 .....	29
Manual Compression Test (N62) .....	30

---

# Engine Diagnosis

**Model: All**

**Production: All**

# OBJECTIVES

After completion of this module you will be able to:

- Understand the Operation of New Generation Engines
- Utilize BMW Diagnostic Equipment to Diagnose Engine Related Complaints
- Understand Engine Diagnosis Using Basic Hand Tools

---

## Engine Diagnosis

When attempting to diagnose driveability complaints, always consider the basics. Regardless of the level of technology employed on an engine, it still needs a few basic things to occur in order to run properly. Whether the engine is very basic or uses so-called “New Generation” technology always refer to the basic principles first.

Any engine using four-cycle spark-ignition principles must meet the same fundamental conditions to run properly. Most engine related driveability problems fall into a few basic categories:

- No Start/No Crank
- Extending cranking before engine start
- Rough Running Cold Idle
- Rough Running Warm Idle
- Rough Running Under Load
- Lack of Power
- Check Engine Light (MIL)



When referring to engine basics, all engines need fuel, air and spark to run. However, in order for a spark-ignition engine to run properly, a few things must be taken into consideration. The fuel, air, spark principle can be broken down further into the following categories:

- Sufficient engine compression with a leak-free combustion chamber.
- Sufficient amount of ignition voltage (spark) at the correct time.
- Proper fuel pressure and volume.
- Properly functioning fuel injection system (Engine management).
- Properly functioning air management system (Electronic throttle systems).
- Correct valve timing (VVT and VANOS).

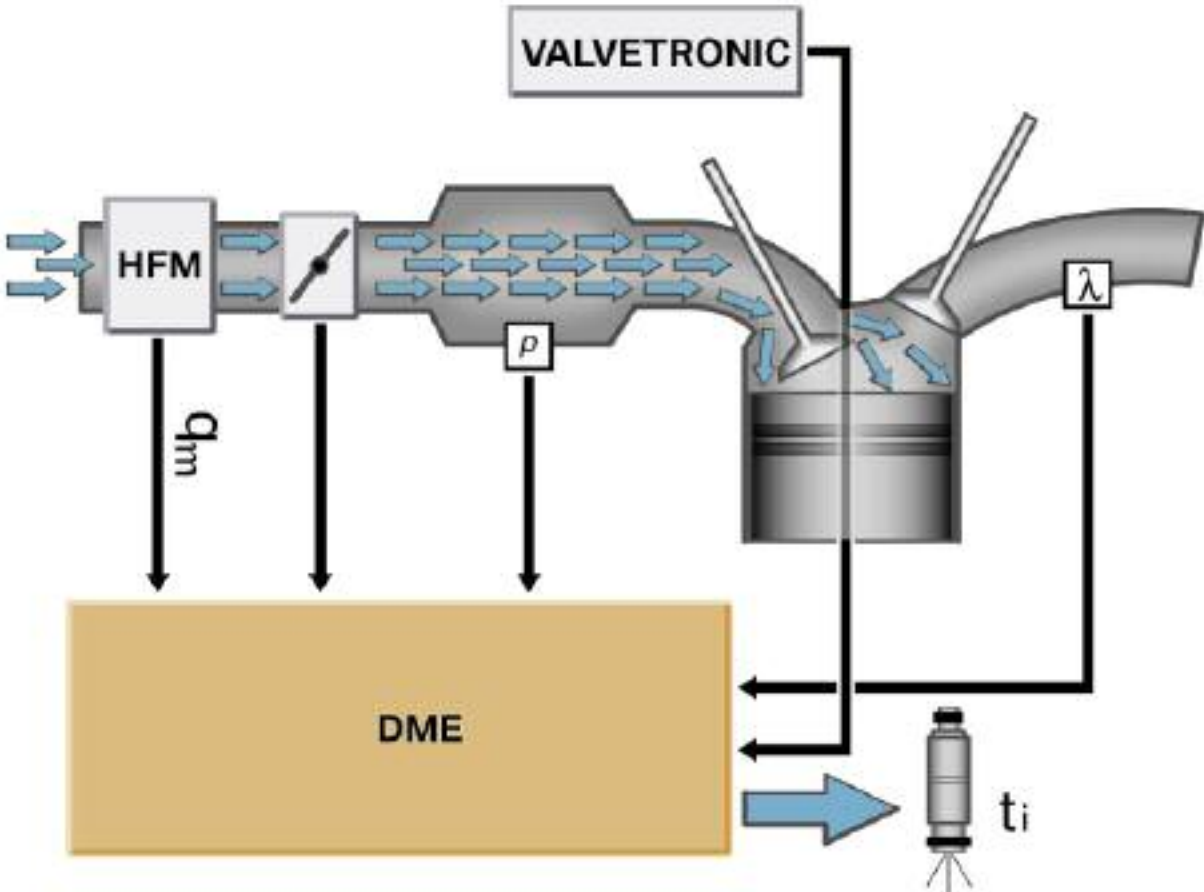

---

## Compression Testing

In order for an engine to run smoothly and efficiently, the combustion chamber must be free of leakage. An engine with low compression in one or more cylinders is inefficient and will run rough or lack in performance. Low compression may or may not cause the MIL to illuminate.

Low compression can be caused by the following:

- Leaking valves caused by burned valves or seats. The valve guide can also be worn causing the valve not to seat properly. Valves can also be bent from piston contact (from over-rev).
- Piston Rings which can be worn from high mileage or poor maintenance. Also, the rings can be damaged from foreign material or improper installation.
- Cracks in cylinder head or engine block. Cracks can be caused by overheating resulting in misfires or rough running.
- Defective cylinder head gasket. The cylinder head gasket can fail due to overheating which can cause cylinder leakage resulting in misfire, low compression and rough running.
- Bent connecting rod. A connecting rod can be bent from a defective fuel injector or water ingress into the combustion chamber causing hydrostatic lock.

Compression testing can be performed using a conventional compression gauge. There are some preliminary tasks and safety precautions that must be carried out before starting the compression test:

- Remove the fuel pump fuse and or relay, start the vehicle and allow vehicle to stall out on residual fuel
- Disable ignition by unplugging all ignition coils and remove **ALL** sparkplugs.
- Connect battery charger to vehicle
- Ensure that the throttle is wide open during cranking (see special note for Valvetronic equipped vehicles).
- Crank engine until compression gauge stops increasing. Be sure to crank engine equally between cylinders.
- Continue compression test on ALL cylinders so comparisons can be done.
- \* Record readings
- If necessary, re-check cylinders with suspect readings.
- If some cylinder readings come up low, add a few drops of oil and re-check. This can differentiate between valves/rings.

---

## Cylinder Leakage Testing

Once a problem cylinder is detected via a compression test or by other means, a cylinder leakage test is used to pinpoint the problem area.

The leakage test uses a gauge and compressed air to indicate the percentage of air loss. By listening and observing at key points, the problem can be narrowed down before the engine needs to be disassembled.

The piston (one or more) should be brought to TDC, compressed air should be introduced into the cylinder using the cylinder leakage tester. Be sure the engine does NOT rotate, if the engine rotates, the engine was not at true TDC.

Check the gauge on the tester, it should read in percentage of leakage. Check the engine specification for permissible leakdown. A general rule of thumb is 15 % or less for a good cylinder. However, some engine have a tighter tolerance. Most BMW engines should be at 8 % or less.

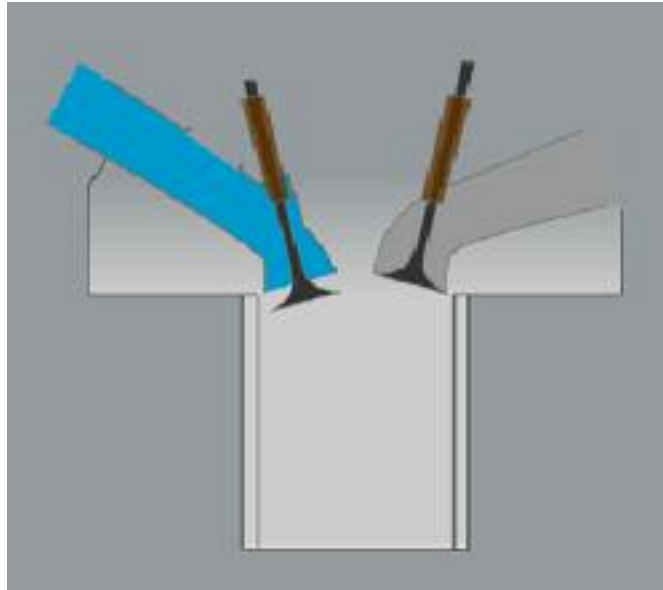

If any cylinder shows excessive leakdown, check for leakage by listening or observing the following points:

- Listen for air (hissing) at the tailpipe. This would indicate leakage at the exhaust valves on that cylinder.
- Listen for air (hissing) at the throttle. This would indicate leakage at the intake valves on that cylinder. (Be sure throttle is wide open and listen at throttle opening)
- Open the oil cap and listen for air. This would indicate air leakage into the crankcase. This would be piston rings or cylinder bore concerns.
- Observe the coolant reservoir and or remove the radiator cap. Bubbles in the coolant would most likely indicate head gasket leakage or cracked block/head.

## Workshop Hints on Cylinder Leakage Testing

When performing cylinder leakage tests, the following tips might be helpful:

- \* Remove all spark plugs to allow easier rotation of the engine. (If this test is done after a compression test, the plugs should already be out).
- Perform the leakage test on all cylinders, not just the problem cylinder. This would indicate any other problems which can be rectified. This eliminates any repeat repairs and wasted diagnostic time.
- Perform the leakage test in cylinder firing order starting with cylinder #1. It takes two revolutions of the engine to complete the leakage test. Start at cylinder #1 and rotate the engine to the next cylinder in the firing order. Divide the number of cylinders into 720, the result is the number of degrees that each cylinder fires. For example, if you divide a 6 cylinder into 720, this equals 120 degrees. If you start at cylinder 1 and rotate the engine 120 degrees in the direction of rotation, you can check the next cylinder in the firing order. This process eliminates the need to rotate the engine an excessive amount.

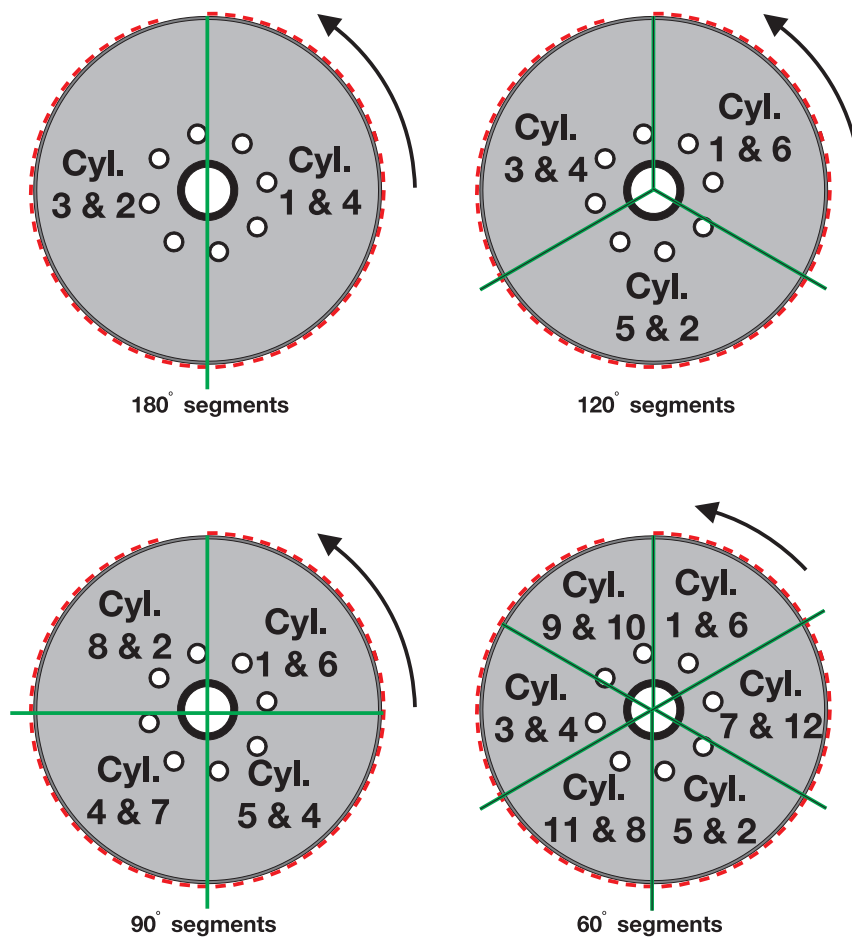

## Cylinder Arrangement and Firing Order

### 4-Cylinder

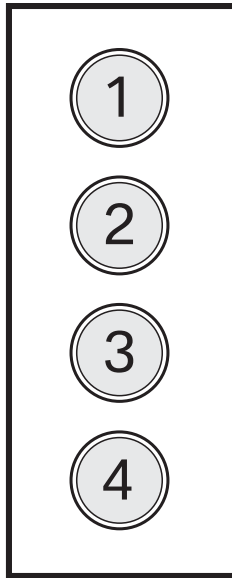

**M10, M42, M44, S14**  
Firing Order 1-3-4-2

### 6-Cylinder

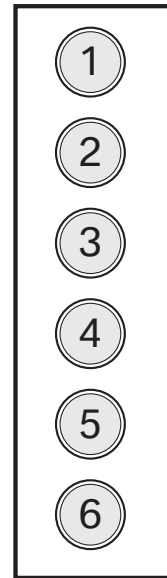

**M20, M30, M50 (TU), M52 (TU),  
M54, N52, S38, S52, S54**  
Firing Order 1-5-3-6-2-4

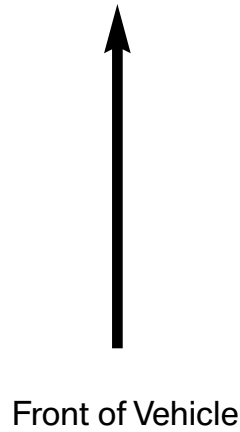

### 8-Cylinder

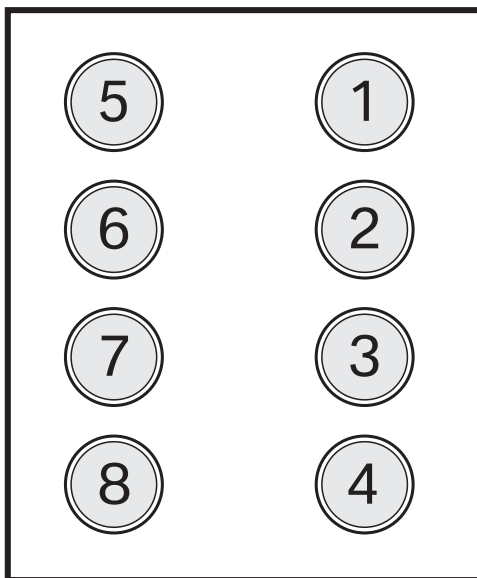

**M60, M62, M62TU, N62, N62TU**  
Firing Order 1-5-4-8-6-3-7-2

### 12-Cylinder

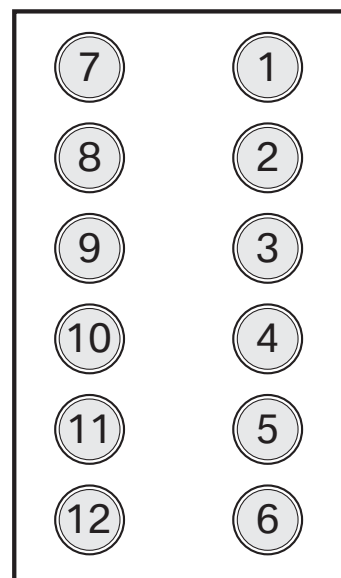

**M70, M73, M73TU, N73, S70**  
Firing Order 1-7-5-11-3-9-6-12-2-8-4-10



## Ignition System Diagnosis

The ignition system on modern BMW engines consist of one ignition coil per cylinder. This arrangement is known as RZV, or Direct Stationary Ignition. The ignition coil receives fused power usually from the DME main relay or IVM (N62).

The ignition coil primary circuit is controlled (triggered) by the engine control module (ECM). The ECM controls dwell and ignition timing on all cylinders individually. Electrical circuit faults on the primary circuit are recorded in the ECM and can be read out using the DISplus or GT-1.

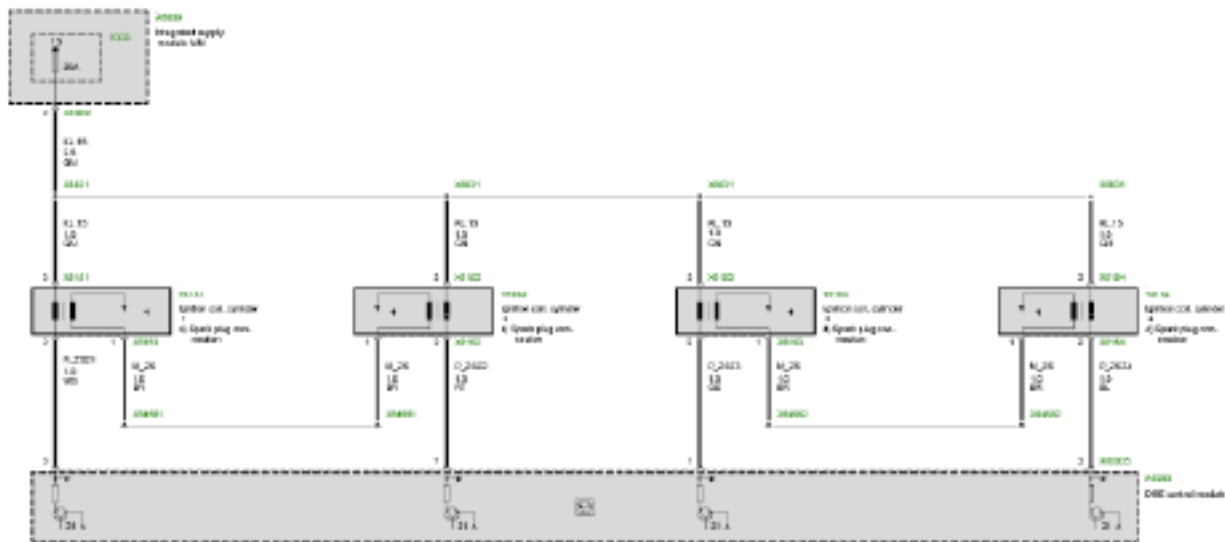

Most new engines use the “pencil” type coil. This design houses the coil windings for the primary and secondary circuit as well as the spark plug boot which includes the secondary circuit resistance.



Due to the compact design of the ignition coil, much of the diagnosis is simplified. Misfire faults and/or ignition related faults can be easily diagnosed by swapping the coils between cylinders. If the fault moves with the coil, then it is obvious that the coil is at fault. If the fault stays in the cylinder, then the spark plug can be moved etc.

This greatly simplifies engine diagnosis. However sometimes, the diagnosis is not always as simple as swapping parts.

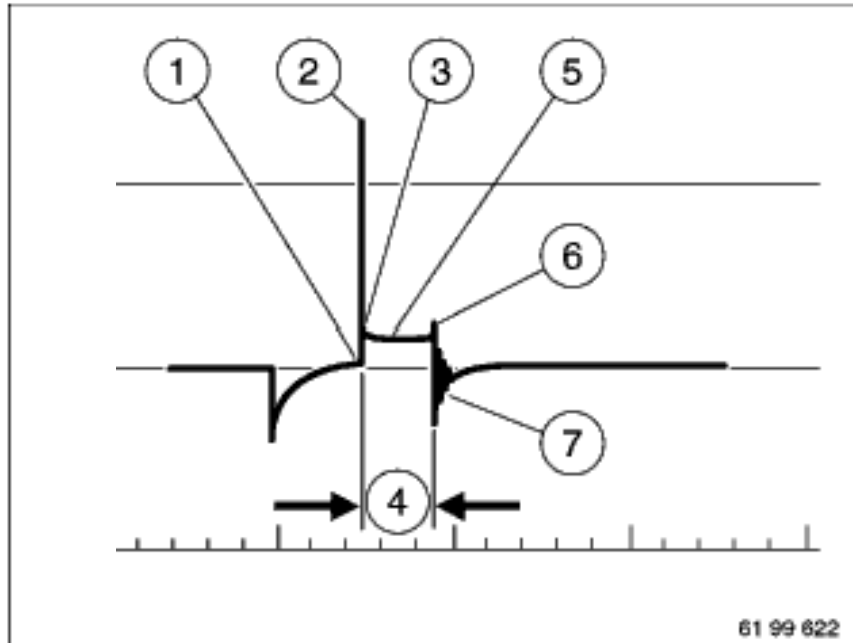

This is where the oscilloscope function of the DISplus/GT-1 can aid in diagnosis. A good knowledge of fundamental ignition diagnosis can be helpful. The illustration above is broken down as follows.

1. This point represent the start of the ignition process, also known as “transistor off”. The ECM turns off the primary circuit causing the magnetic field to collapse. This begins the production of the secondary voltage needed to fire the spark plug.
2. The is called the firing line as it represents the voltage needed to overcome the secondary resistance and cross the spark plug electrode gap. This voltage level will increase as secondary circuit resistance increases. Also lean mixture will cause this line to increase as well. On RZV ignition systems, this line should be around 3-5kV.
3. This line indicates the start of the combustion process. This is also referred to as the spark line. The line should start relatively level and should be about 1/3 to 1/2 of the height of the firing line. Also, there should be no rapid upward or downward slope.

4. This period of time represented here is the combustion period. This area indicates the integrity of the combustion event. Problems such as low compression, lean or rich mixture problem would be indicated here.
5. This line represent the voltage present during the combustion period. This line should be mostly level. Upward or downward sloping can indicate mixture or engine compression problems.
6. This point represents the end of the combustion process. Combustion has ended and the remaining voltage available is the coil will start to dissipate.
7. This is known as the coil or decay oscillation period. Any excess voltage not used in the combustion process will “decay” and dissipate. The number and pattern of the oscillations is dependent on the coil type. Different types of coils and different coil manufacturers will be a factor on this pattern. Anywhere from 2 to 6 oscillations may be seen here. If no oscillations are present, this would indicate ignition coil internal problems.

Most newer engine use a “multiple spark” discharge when the ignition coil is triggered. This is to aid in startup. When diagnosing these ignition systems, the additional peaks do not need to be factored into your diagnosis.

Referring to the illustration below, the relevant portion of the scope pattern is at point 1.

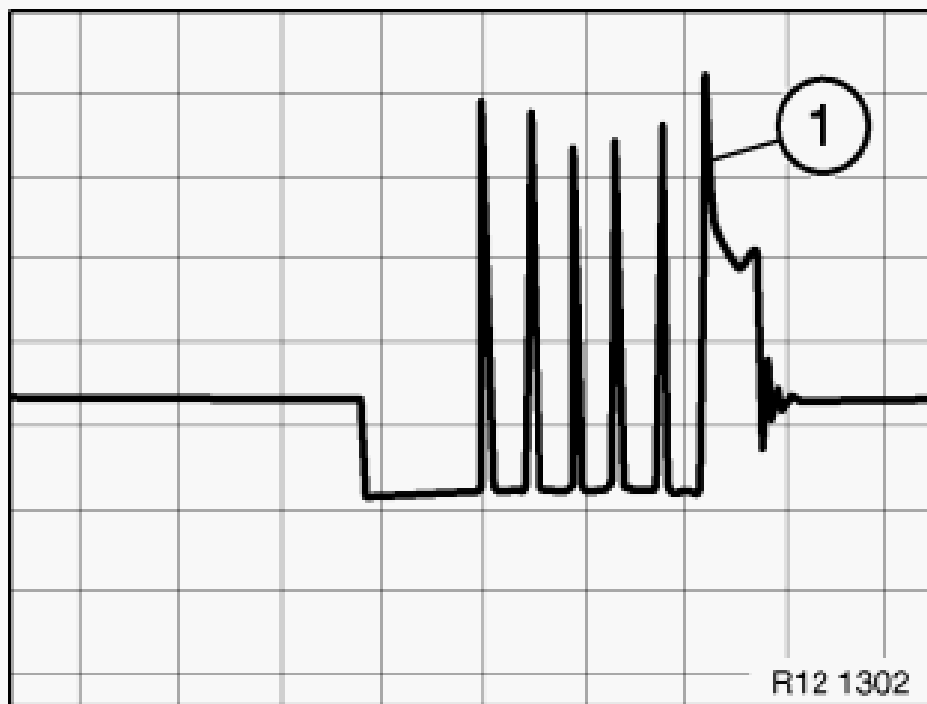

## Fuel System Testing

Fuel systems need to be checked for proper fuel pressure as well as sufficient volume. When diagnosing fuel system complaints, you must take into account the type of fuel system and how the fuel is delivered to the engine.

Malfunctions in the fuel system can cause driveability complaints which include:

- No start condition
- Hard start/extended cranking time
- Lack of power
- Check Engine (MIL) Light along with mixture related faults
- Excessive exhaust emissions (High CO and/or HC)

When a no start condition is experienced, it is important to start with the basics. Does the vehicle have any fuel in the tank? Don't assume that there is fuel, the fuel gauge or sender circuit may be faulty. Also, the siphon jet system may be defective. Check the fuel level using the instrument cluster test steps if necessary. Check to be sure that there is fuel available on the right side of the fuel tank.

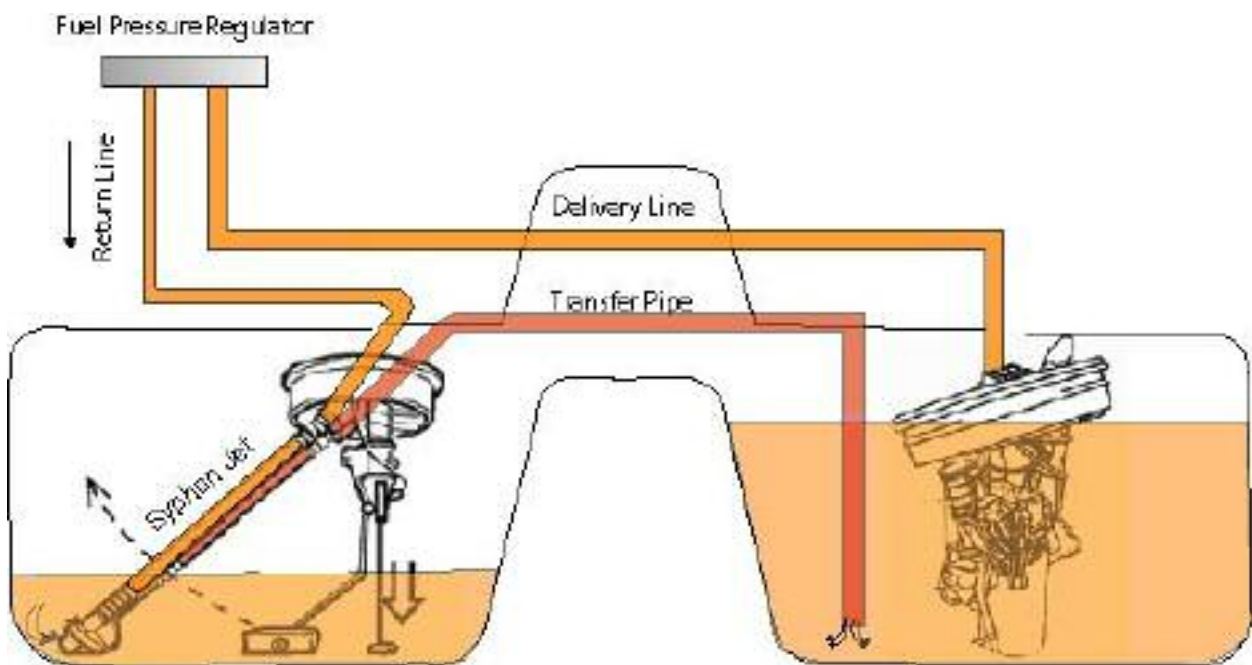

Once it has been determined there is fuel in the tank. The fuel system can be tested for proper pressure. Fuel pressure specifications vary between vehicles. Until recently, most fuel systems used a pressure of 3.5 bar. Some of the new systems use up to 5 or 6 bar. Direct injection systems use 6 bar for the fuel supply system and up to 120 bar pressure to the fuel injectors. Refer to appropriate specifications in WebTIS for the proper system pressures and testing procedures.

The fuel supply system should be tested using the appropriate fuel pressure gauge. Depending upon the vehicle, the testing methods and connections for the fuel pressure testing equipment differ.

Some vehicles have testing ports with a Schrader valve for easy hookup. Earlier vehicles did not have a test port. Testing fuel pressure required the use of a "T" connector to connect into the fuel system.

Most recently, M56 equipped (SULEV) vehicles have a sealed fuel system which require the use of a special tool. Refer to the latest service information bulletin.

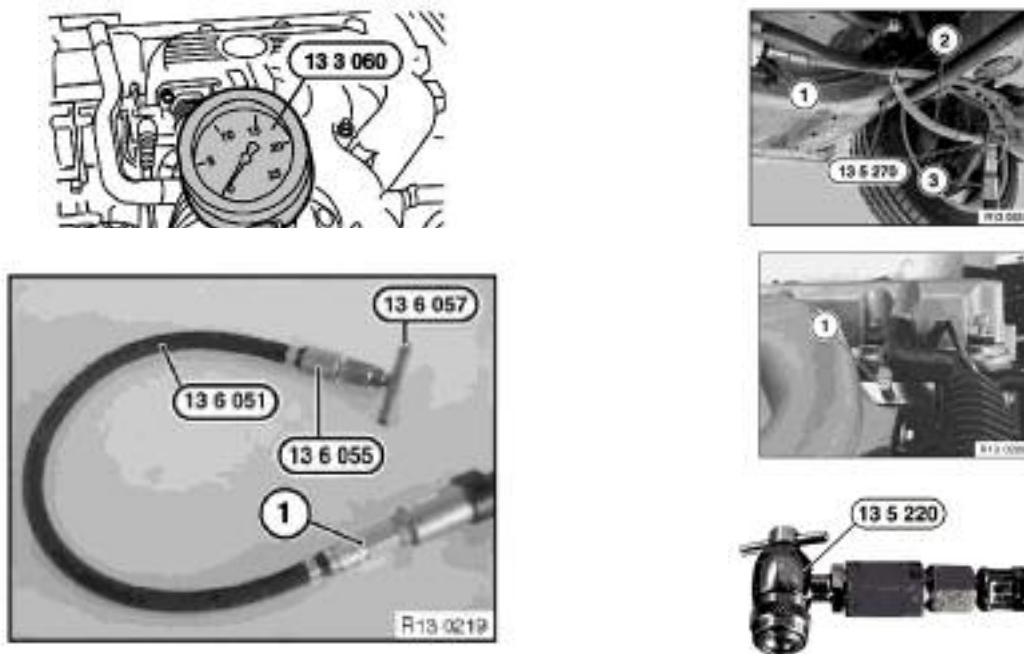

**Note: Always observe all safety regulations when working on fuel systems. Obey all local and state fire safety laws regarding fuel handling. Always have the proper fire extinguisher on hand when performing testing and/or repair to the fuel system.**

Once it has been determined that what the fuel pressure is, compare your reading to the proper specification. If the fuel pressure is low or zero, the fuel circuit must be checked over.

See if the fuel pump is energized. Check the voltage supply and ground to the fuel pump using proper electrical testing procedures (i.e voltage drop etc.). Make sure that you analyze the fuel pump circuit. Check the fuses, connections and appropriate relays.

Also, understand the operation of the fuel pump circuit. Older vehicles were somewhat straightforward, on the other hand, the newer vehicles are using more elaborate circuits for fuel pump operation.

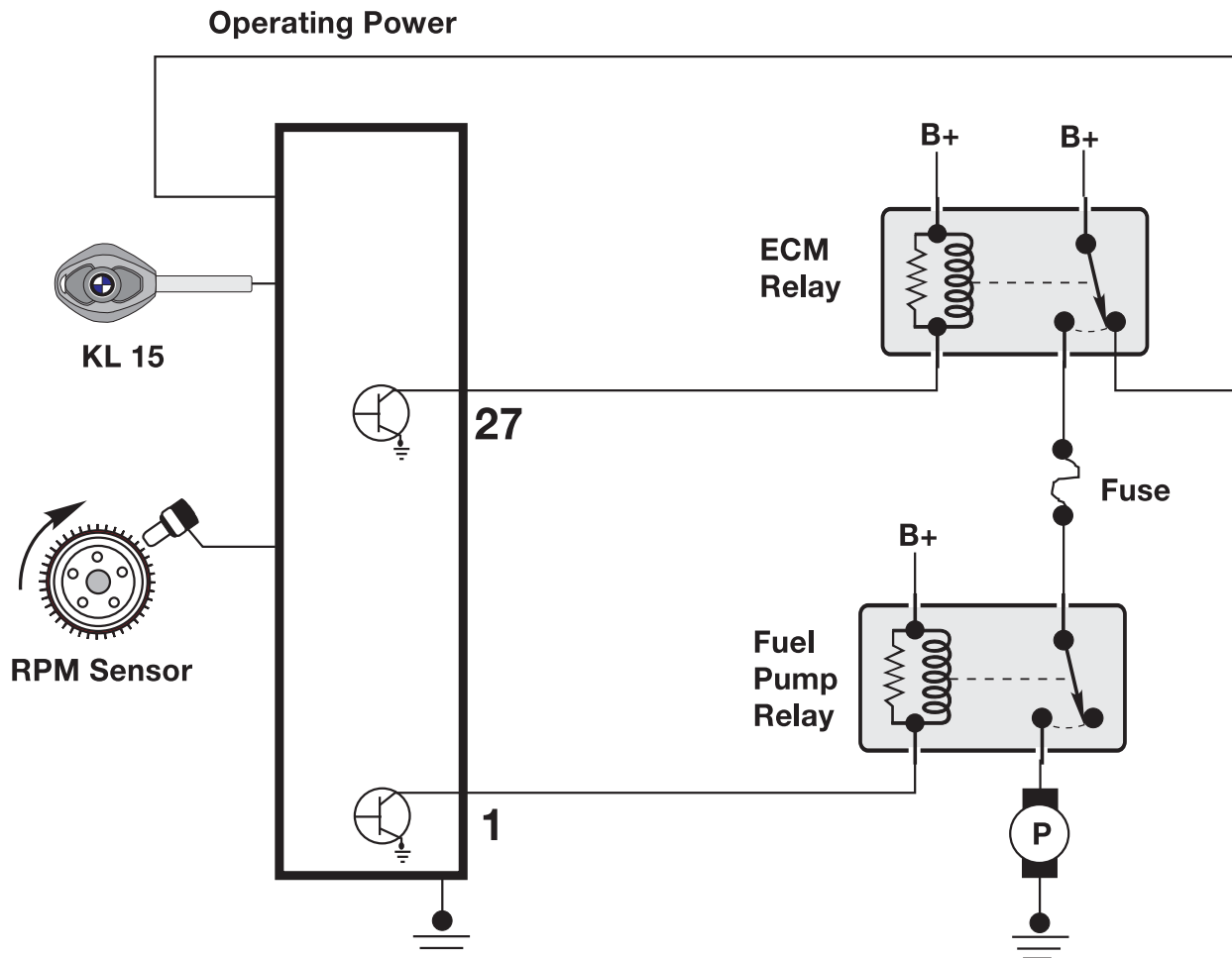

Some vehicles, now use a control module to control the speed and flow rate of the fuel pump. The M3, M5 and vehicles equipped with the M56 engine use a fuel pump control module. The E65/E66 uses the SBSR to control the fuel pump. Take this into consideration when performing diagnosis on these vehicles.

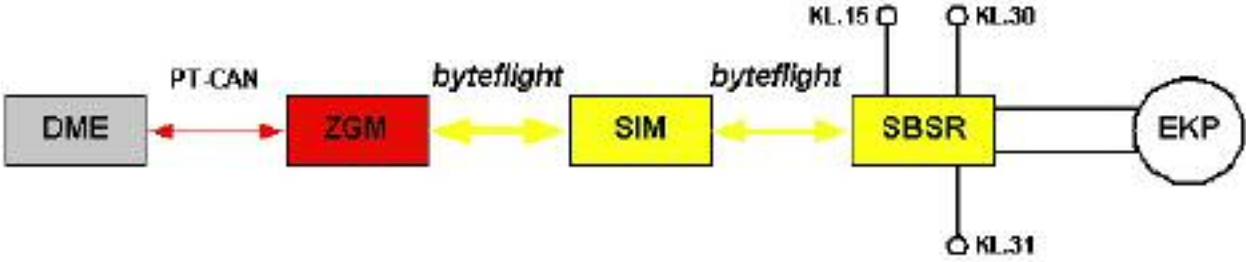

Always use available resources such as wiring diagrams, SI Bulletins and training material to better understand circuit operation.

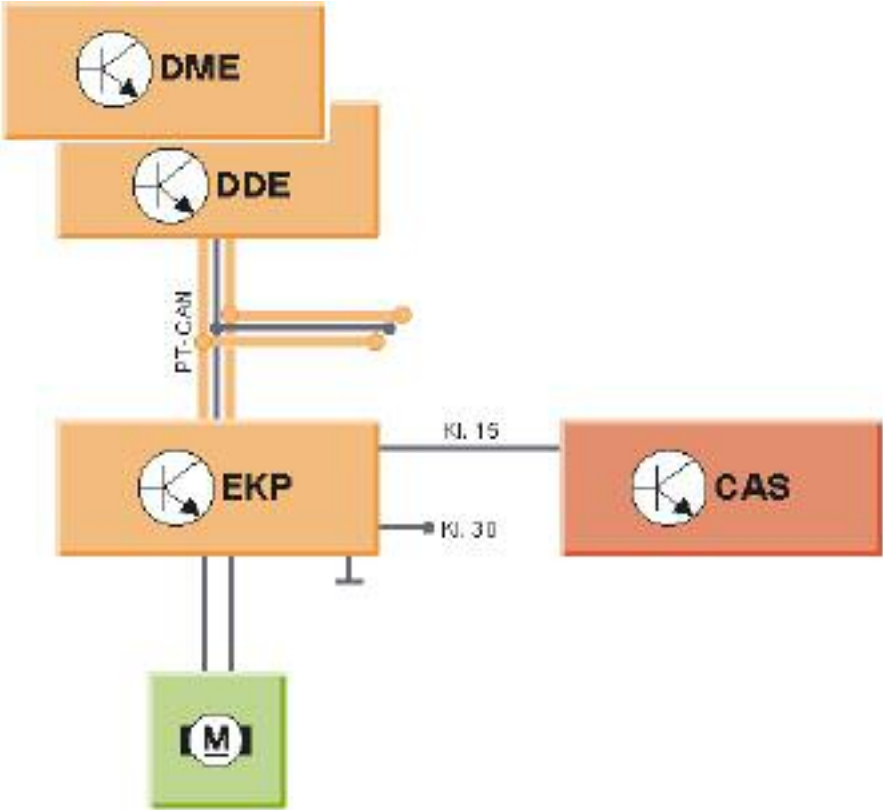

---

## Fuel Volume Testing

Some driveability concerns are related to incorrect fuel volume. Vehicles with lack of power complaints and mixture related fault codes may have insufficient fuel volume supplied to the fuel injection system. These vehicles may actually pass a fuel pressure test.

Fuel volume issues can be caused by faulty fuel pumps, fuel pressure regulators, clogged or restricted fuel filters and/or fuel lines.

If these driveability concerns are present, then a fuel volume test should be performed. A fuel volume test measures the amount of fuel delivered in a specific time frame.

The fuel pump is activated during this test using the proper test leads to ensure no arcing sparks are present. The fuel feed line is directed to a non-breakable (fuel-proof plastic) measuring can that has graduations for measurement.

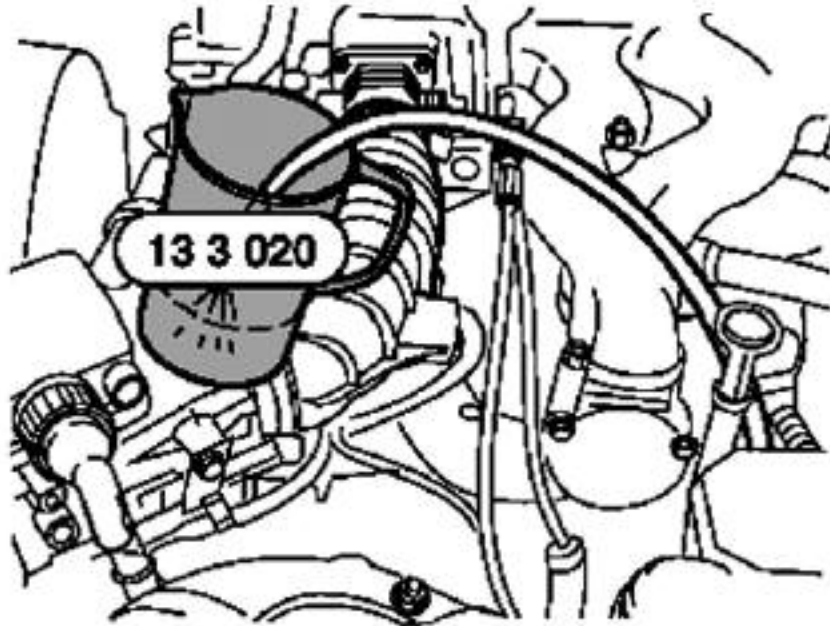

A general specification for fuel volume would be approximately one liter in 30 seconds. Always check WebTIS for the exact specification for the vehicle you are working on.



## Residual Pressure

Fuel injection systems require a residual pressure to present after the engine is switched off. This allows the engine to start immediately after the vehicle has been parked.

If the residual fuel pressure diminishes after the vehicle has been shut off. Upon restart, there will be an extended cranking period before engine start. This is due to the fuel pump attempting to supply enough fuel for startup.

When the fuel system is at rest, there are three components which allow the fuel system to retain sufficient residual pressure. These items are, the fuel pump check valve, the fuel pressure regulator and the fuel injectors.

### Fuel System - E32 with M60

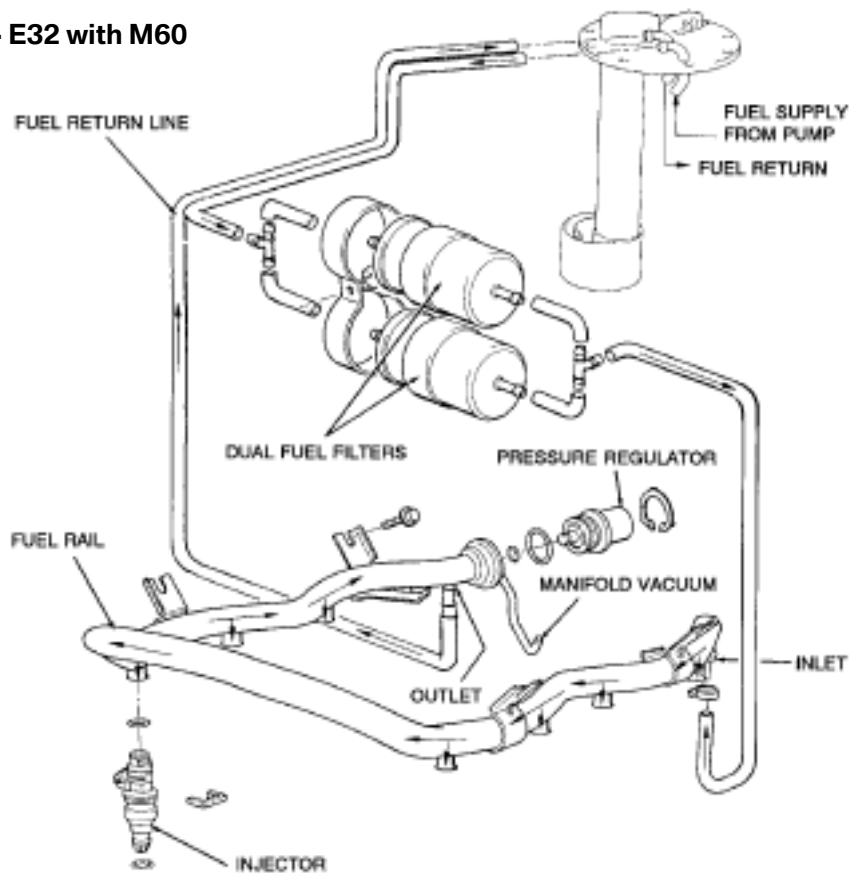

If any of these items are leaking and fail to hold pressure in the fuel rail, the vehicle will be difficult to start. The cranking time will be excessive and possibly not start at all. For example, If the fuel injectors are leaking, the vehicle will exhibit black smoke on startup.

Diagnosis of these concerns requires a fuel pressure gauge. The residual pressure is monitored on the fuel pressure gauge when the engine is shutoff. Diagnosis is determined by watching the drop in fuel pressure over time. The fuel pressure should not drop more than .5 bar in 30 minutes. If the pressure drops more than .5 bar, the concern should be investigated.

### Fuel System - E39/E46 with M54

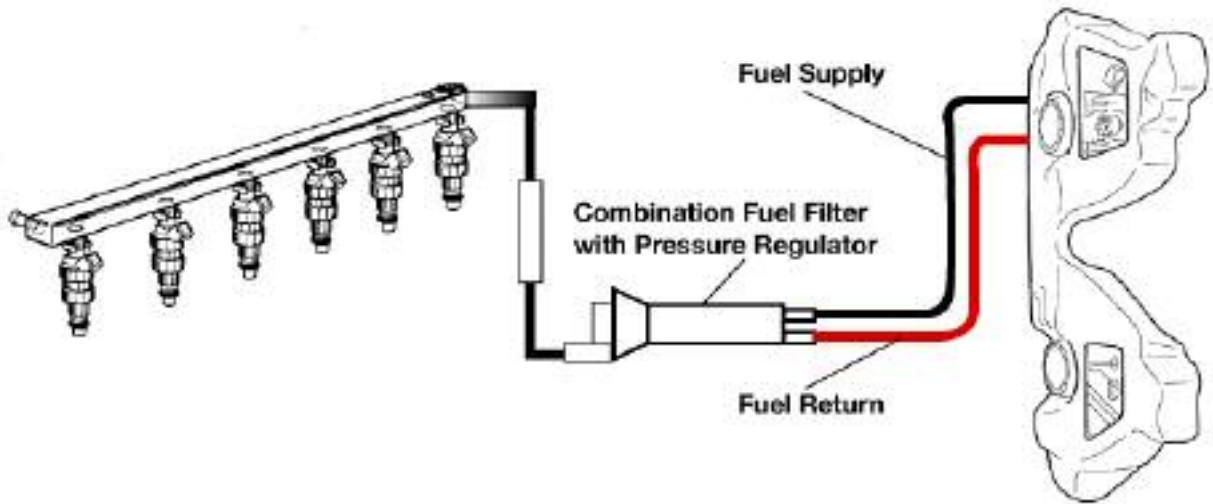

Depending on the type of fuel system used, diagnosis will vary. On older fuel systems, diagnosis is simplified due to the ability to clamp off certain components to determine, the origin of the leakdown.

### Fuel System - E60

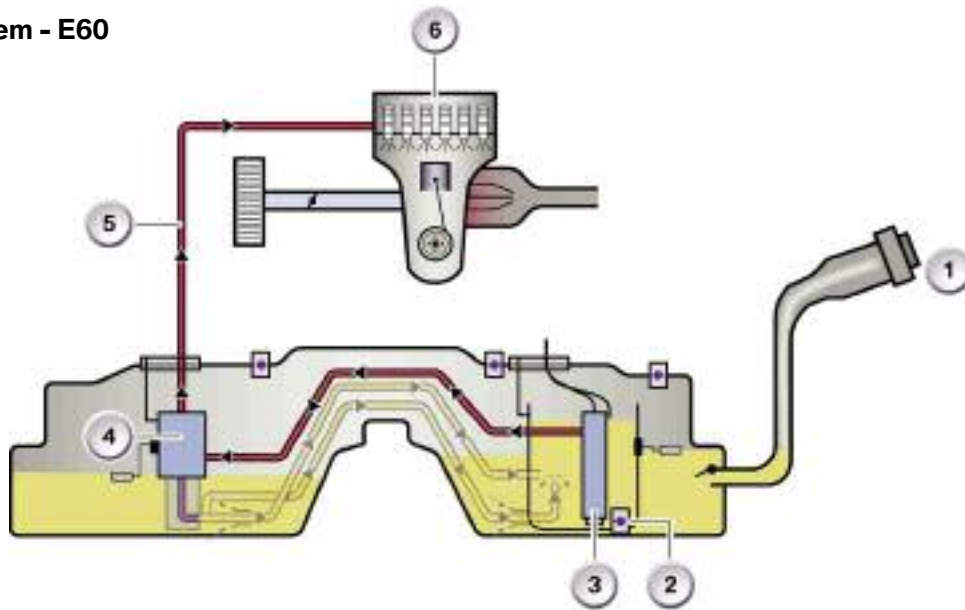

Index	Explanation	Index	Explanation
1	Fuel Filler Pipe	4	Fuel Filter
2	Outlet Protection Valve	5	Feed Line
3	Electric Fuel Pump	6	Fuel Injectors/Fuel Rail

---

Newer fuel systems use a non-return type fuel system with some components mounted externally. Most recently, many of the new vehicles have most of the fuel system components mounted in the fuel tank. This includes the fuel pump, fuel filter and fuel pressure regulator. The only fuel system component outside the fuel tank is the fuel feed line, fuel rail and fuel injectors.

This makes the diagnosis of residual pressure concerns more difficult. Diagnosis of this type of system sometimes requires a process of elimination.

If one or more of the fuel injectors is suspected as the cause of the loss in residual fuel pressure. They can be tested using a special tool to “bubble test” the injectors.

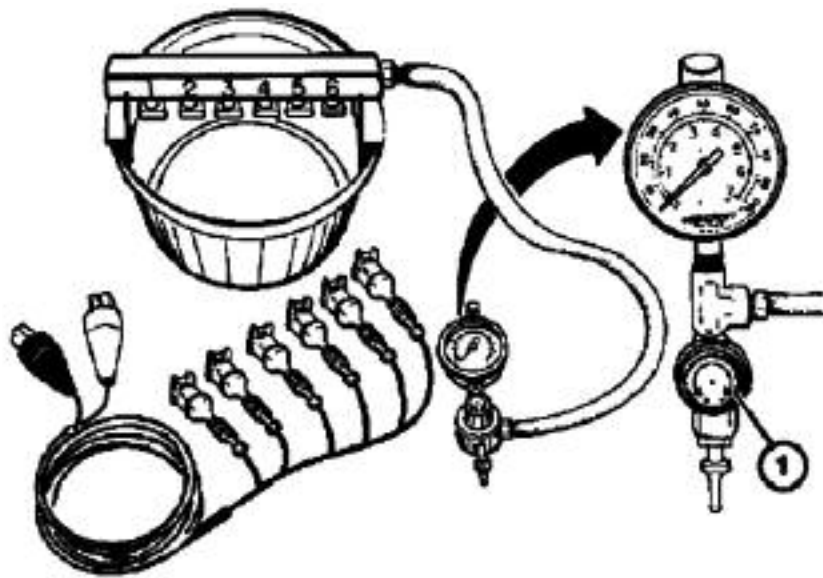

First the injectors are connected to the test fuel rail supplied with the tool. Then, the fuel injectors are subjected to compressed air. The injectors are then triggered by the test harness to “blow out” any residual fuel.

The test harness is disconnected and the tips of the injectors are immersed in water. The injector tips are observed for any bubbles over time. Any excessive bubbles indicate a defective injector.

---

## Engine Adaptation Values

Engine adaptation values can be broken down into two categories:

- **Additive Mixture Adaptation** - additive adaptation refers to “long term fuel trim”. These adaptation are made by the ECM (DME) at idle during “closed loop” fuel control. These values are measured in milliseconds and are expressed in negative and positive values.
- **Multiplicative Mixture Adaptation** - multiplicative adaptation occurs during part load conditions and are performed by the ECM during “closed loop” fuel control. These values are measured in percent and are also expressed as negative and positive values. This is also referred to as “short term fuel trim”.

Additive mixture adaptation corrects for variations in idle mixture. The ECM monitors the oxygen sensor signals to evaluate the exhaust mixture. When a lean (or rich) mixture is detected, the ECM increases (or decreases) the injector “on-time” to correct accordingly.

As long as the fuel trim correction is not excessive, the ECM will not register a fault code. The ECM will correct in increments of +/- .1 ms. When the fuel trim correction exceeds a predetermined threshold value, the check engine light (MIL) will illuminate and store appropriate fault codes for additive mixture adaptation.

Additive values which are excessively positive, would indicate a lean condition. This can be caused by:

- Un-metered air leaks - such as broken vacuum lines or a leaky intake manifold or gasket.
- Faulty crankcase ventilation system - crankcase vent valve stuck open.
- Low fuel pressure - Faulty fuel pressure regulator or fuel pump.
- Faulty HFM - can be sending erroneous load signal information which would cause the ECM to falsely enrich the mixture.

Additive values which are excessively negative, would indicate a rich condition. This can be caused by:

- An air restriction - any restriction to airflow such as a clogged air filter would create a rich fuel mixture. (this may also be indicated by negative multiplication values)
- Faulty crankcase ventilation system - crankcase vent valve stuck closed.
- High fuel pressure - Possible faulty fuel pressure regulator or restricted return line
- Faulty HFM - can be sending erroneous load signal information which would cause the ECM to falsely lean out the mixture.

**Note: Some newer engine management systems use the term mg/stroke or milligrams per stroke. Treat these values as you would millisecond values.**

---

Multiplicative mixture adaptation corrects for variations in fuel mixture under part load conditions. The ECM monitors the oxygen sensor signals to evaluate the exhaust gas mixture. When a lean (or rich) mixture is detected the ECM adjusts the injector “on-time” accordingly over a “short term” period to adapt for the existing situation.

Multiplicative values are expressed in percent and can be negative or positive. Negative values indicate a rich mixture and positive values indicate a lean mixture. When the Multiplicative values exceed a predetermined threshold value, the check engine light (MIL) will illuminate and store relevant fault codes for Multiplicative adaptation.

When multiplicative values are excessively positive, a lean condition exists. The ECM is attempting to add fuel to maintain the proper fuel mixture (close to lambda value 1). This situation can be caused by a faulty HFM, low fuel volume, restricted fuel filter or faulty fuel pressure regulator.

When the values are negative, the ECM is attempting to lean out (remove fuel) the fuel mixture to compensate for a rich condition. This can be caused by:

- Excessive fuel pressure - from a faulty fuel pressure regulator or restriction in the return line.
- A faulty HFM - the HFM can be sending erroneous load signal information which would cause the ECM to falsely enrich the mixture.
- An Air restriction - any restriction to airflow such as a clogged air filter would create a rich fuel mixture.
- Any system failure which would cause the mixture to be falsely enriched. This could be caused by erroneous signal information from sensors such as the engine coolant temperature sensor or intake air temperature sensor.

## Engine Misfire Diagnosis

Engines which have been produced since 1996 are OBDII compliant. The CARB/OBD regulations require the ECM to be capable of detecting misfires. Also, the ECM must be able to determine if the misfires increase engine emissions and/or are catalyst damaging.

The ECM detects engine misfires by monitoring crankshaft speed. The ECM receives the input from the crankshaft sensor and determines if there is a misfire present by comparing crankshaft speed variations between combustion events on each cylinder.

The crankshaft must rotate 720 degrees (2 rotations) to fire all of the cylinders in an engine regardless of the number of cylinders. Therefore each firing event is spaced apart and occurs at a specific time. By monitoring the crankshaft signal the ECM can determine which cylinder is misfiring and also the severity of the misfire.

Misfires are classified in 2 levels of severity:

- Misfires which increase emission levels - These misfires occur within an interval of 1000 crankshaft revolutions. The ECM counts and adds the detected misfire events for each cylinder. If the sum of all cylinder misfire incidents exceeds the predetermined value, a fault code will be stored and the "MIL" will be illuminated.

If more than one cylinder is misfiring, all misfiring cylinders will be specified and the individual fault codes will be stored. The "MIL" will be illuminated.

- Misfires which are catalyst damaging - These misfires are determined when the sum of the misfiring events occurs within 200 crankshaft revolutions. These misfires are considered catalyst damaging and the "MIL" will be illuminated.

The ECM will take the following measures - the oxygen sensor control will be switched to "open loop", a cylinder selective fault code will be stored for one or more cylinders and the relevant fuel injector(s) will be deactivated.

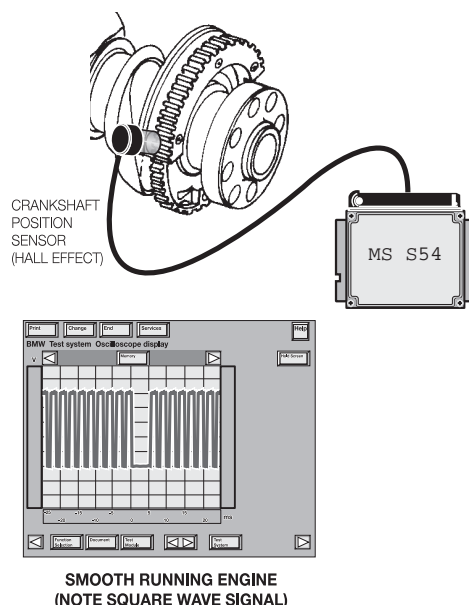

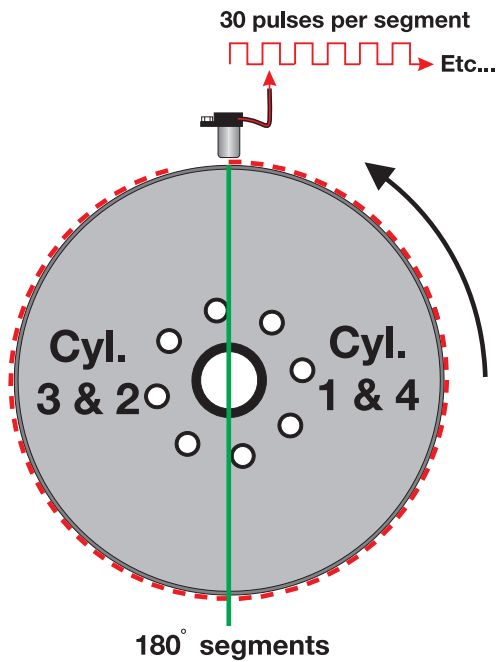

180° segments  
Internal pulse wheel- M44, 4 cylinder

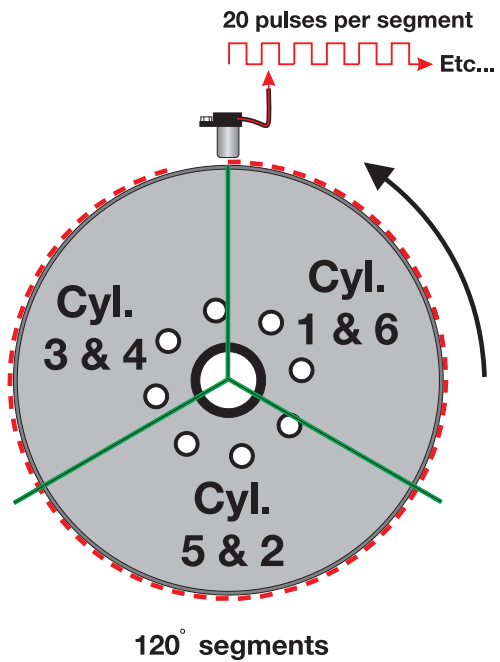

120° segments  
Internal pulse wheel- M52, 6 cylinder

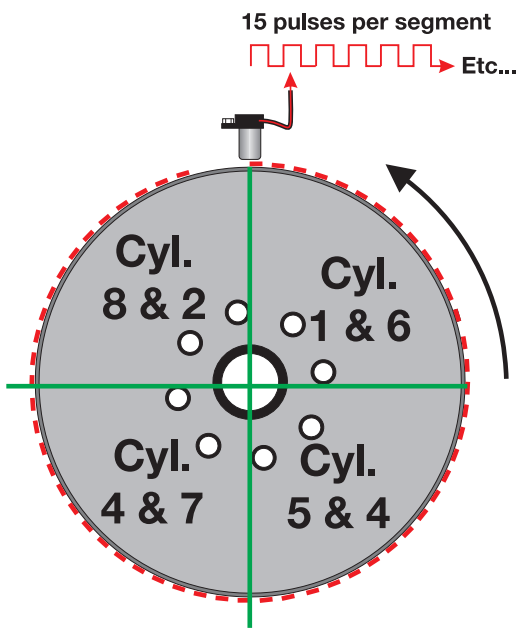

90° segments  
External flywheel incremental  
pulse wheel- M62, 8 cylinder

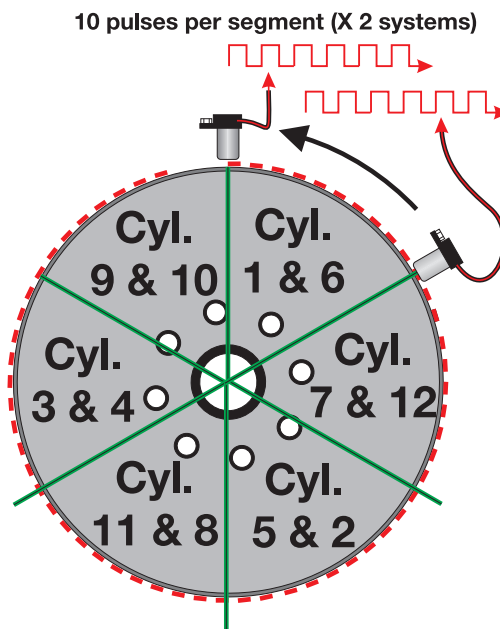

60° segments  
External flywheel incremental  
pulse wheel- M73, 12 cylinder  
(2 systems monitoring same  
crankshaft)

The causes of engine misfires include:

- Ignition System - spark plugs, ignition coils, secondary circuit components and primary/secondary circuit wiring.
- Engine Mechanical - piston, piston rings, valves, camshaft and any valvetrain related components including Valvetronic. Valvetronic components include eccentric shaft, intermediate levers etc.

The crankcase ventilation system should also be considered. This includes the crankcase ventilation valve and if applicable, the hose connections as well.

- Fuel System - fuel injectors, fuel pump, fuel filter and pressure regulator etc. This includes fuel quality as well. Other fuel system components include fuel tank vent valve (purge) as well as running losses components such as the 3/2 valve etc.
- Engine Electronics - any implausible input from a sensor such as the crankshaft sensor and camshaft sensor. Also any sensor which affects fuel mixture including HFM, coolant/intake air temperature sensors etc.
- Other items include the catalyst which could be restricted and/or the muffler.

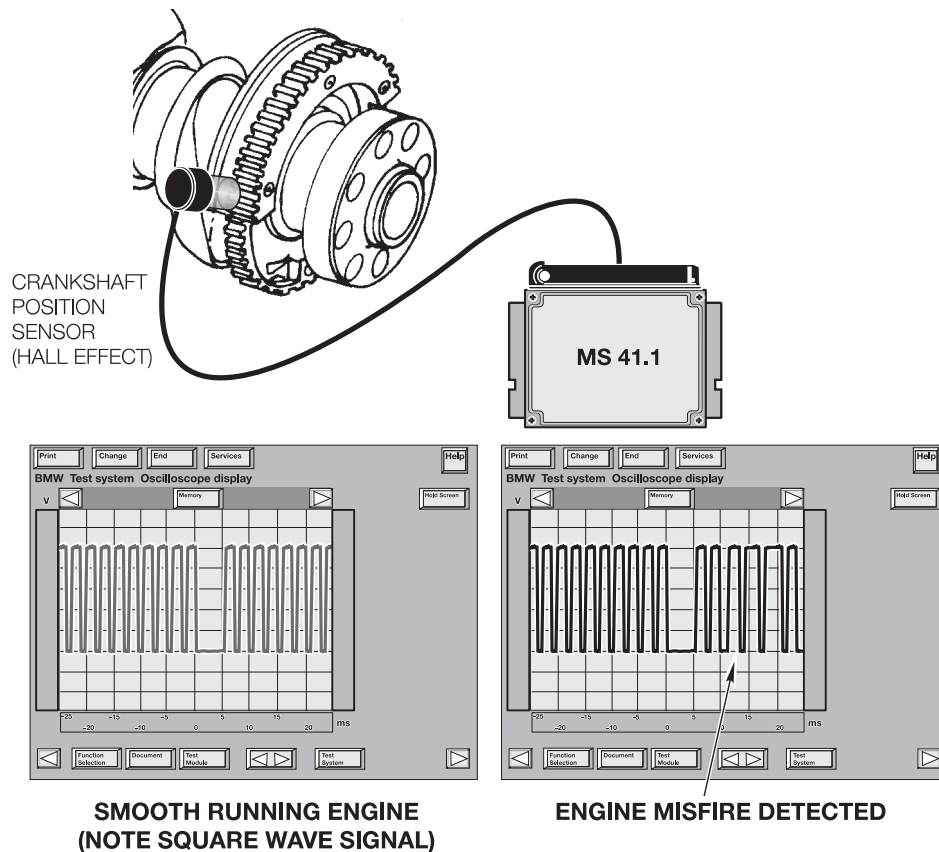



## Smooth Running Measurement

The DISplus/GT-1 are helpful in pinpointing the cause of an engine misfire. Once the short test is completed, the fault memory of the ECM can be read out to determine which cylinder or cylinders have set misfire faults. There may or may not be any faults present. The engine could be running rough, however no misfire thresholds may have been exceeded.

Engine smoothness can be further evaluated by looking at the smooth running values. In the “Control Unit Functions” screen under “Diagnosis Requests” there is a value indicated for each cylinder which can be compared for each cylinder. This value is an indication of crankshaft speed variations in each cylinder.

**Diagnosis Control unit functions**

Control modules	Functions	Part functions
CCC-GW Gateway	Identification	- Sensor heater behind cat., cyl. 1-4
<b>DME Engine management (ME)</b>	Identification long	- Sensor heater behind cat., cyl. 5-8
PDC Park Distance Control	Read fault memory	= Rough-running value, cylinder 1
MPM Micro-power module	Clear fault memory	= Rough-running value, cylinder 2
RLS Rain/driving lights sensor	Physical hardware number	= Rough-running value, cylinder 3
SBSL Satellite, B-pillar, left	Read test code	= Rough-running value, cylinder 4
SBSR Satellite, B-pillar, right	Clear mixture adaptation	= Rough-running value, cylinder 5
SFZ Satellite vehicle center	Component activation	= Rough-running value, cylinder 6
SGM-SIM Safety and Gateway Module	<b>Diagnosis requests</b>	= Rough-running value, cylinder 7
TMFA Door module, driver		= Rough-running value, cylinder 8
TMBF Door module, front passenger		- Lift, intake valves, cyl. 1-4
SZL Switch center, steering column		- Lift, intake valves, cyl. 5-8
VTC1 Valvetronic, bank 1		- Calibration angle, cyl. 1-4
VTC2 Valvetronic, bank 2		- Calibration angle, cyl. 5-8

Messages and results

Message	Value	Unit
Rough running, cylinder 1	-0.95	1/s <sup>2</sup>
Rough running, cylinder 2	-0.06	1/s <sup>2</sup>
Rough running, cylinder 3	0.43	1/s <sup>2</sup>
Rough running, cylinder 4	0.11	1/s <sup>2</sup>
Rough running, cylinder 5	0.55	1/s <sup>2</sup>
Rough running, cylinder 6	-0.22	1/s <sup>2</sup>
Rough running, cylinder 7	0.62	1/s <sup>2</sup>
Rough running, cylinder 8	-0.47	1/s <sup>2</sup>

---

## Valvetronic N62

In addition to the usual valvetrain diagnosis, the Valvetronic system has some additional components which need to be taken into consideration during diagnosis. The tolerances on the eccentric shaft and intermediate levers are critical in maintaining proper cylinder filling especially at idle. Any deviations in tolerances of these components will contribute to rough running complaints.

The intermediate levers are available in 5 classifications, the classification numbers are marked on the levers. On the N62, each cylinder head must use intermediate levers with the same classification. It is not necessary to have the same classification between cylinder heads.

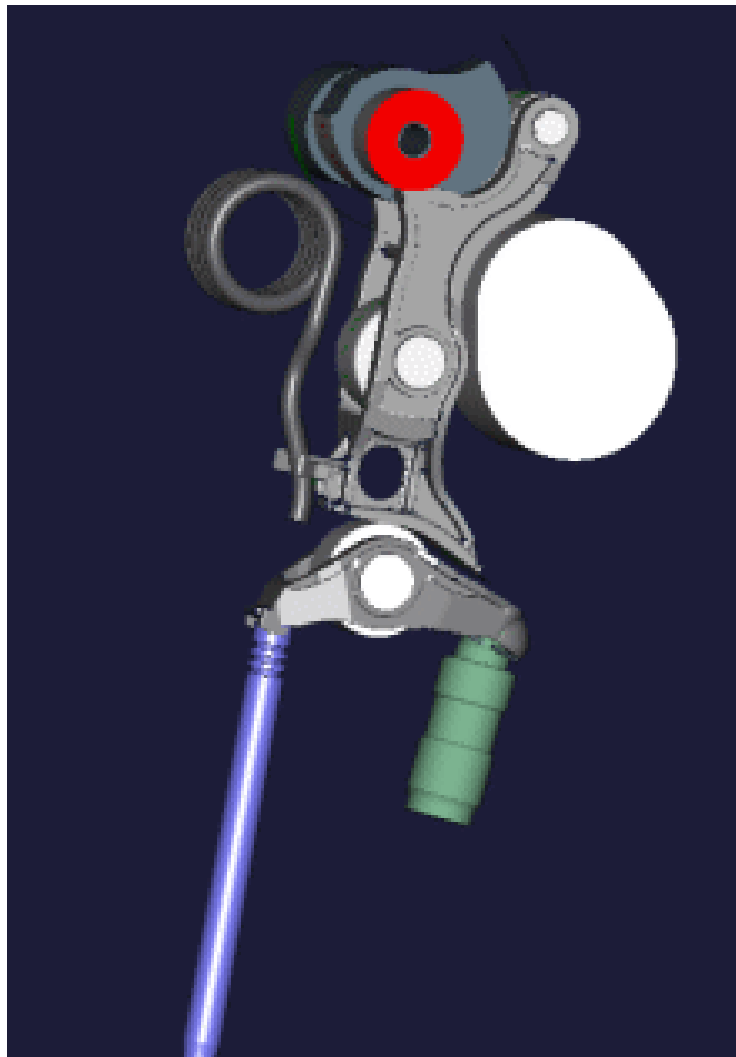

---

Depending on the engine/vehicle, the minimum valve lift can be set from .3 to .8 mm. At these low valve lifts, any variation in tolerance will affect idle quality. When a diagnosis determines that there is a problem in the Valvetronic system, the components need to be inspected. The intermediate levers or eccentric shaft can be worn. The intermediate levers could be of the wrong classification.

The illustration below shows a worn eccentric shaft. The areas shown should be inspected for any wear. Grooves and scoring indicate a worn eccentric shaft which should be replaced.

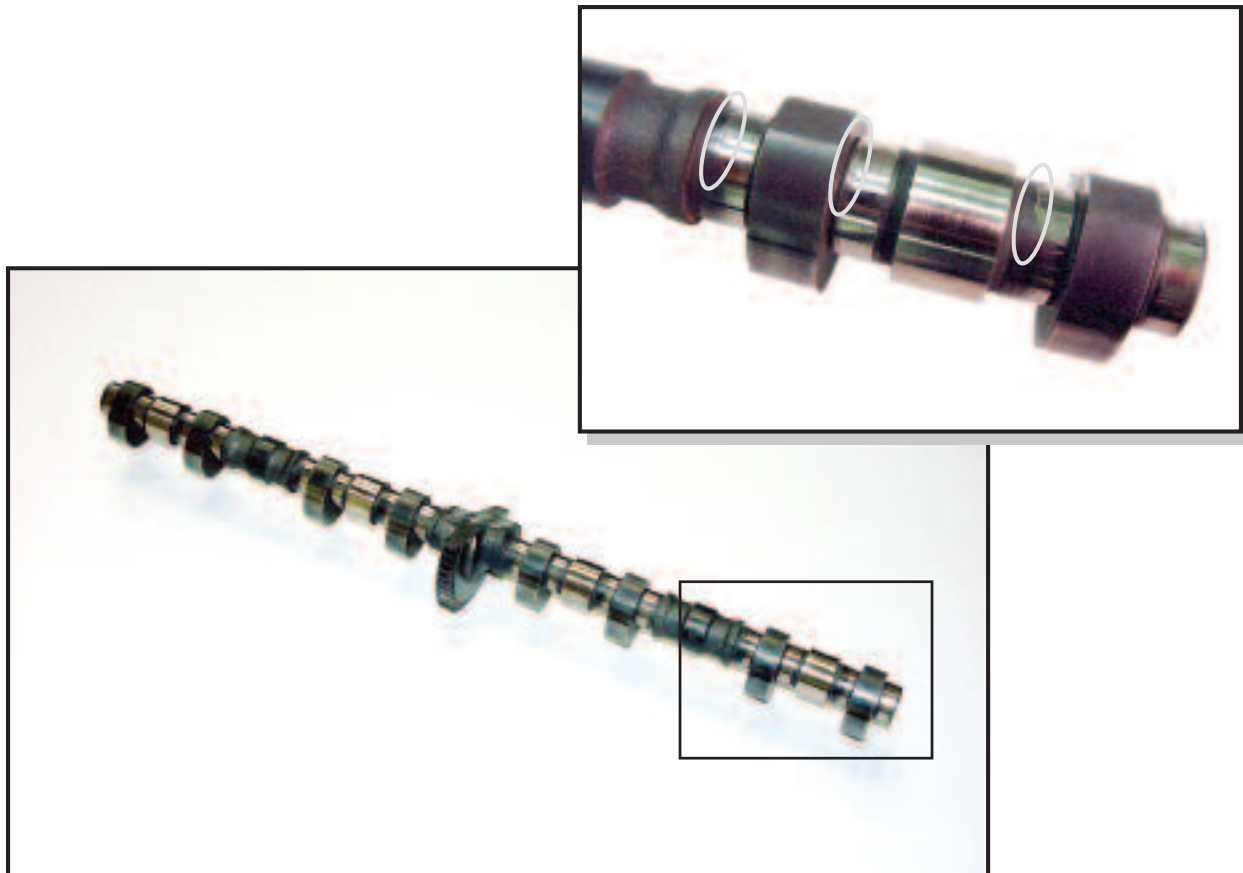

The following pages contain testing information which will assist in the diagnosis of idle quality concerns on the N62. When diagnosing complaints regarding the N62 engine, always refer to the latest available Service Information Bulletins on WebTIS. Enter all recorded test information regarding these cases into PuMA.

---

## N62 Engine Testing

The N62 engine features Valvetronic which requires some specialized diagnostic procedures. Due to the variable valve lift feature, there are some additional steps regarding engine and compression testing.

### MKA Adapter

The Multi-Channel Adapter (MKA) tool is used in conjunction with the DISplus to diagnose ignition and injection system concerns on the N62 engine. The MKA adapter is installed (in series) between the ECM and the engine harness at connectors 1, 3 and 5. In addition the four cables of MFK 2 are plugged into the MKA as well.



The MKA test module is found under the path > Service Functions > Drive > Engine Management ME9 > Test Runs > Ignition and Injection diagnosis N62.

The MKA engine test checks the integrity of the ignition system by looking at the primary ignition voltage on each cylinder.

The injection system is also checked by examining the voltage pattern of the injection circuit.

## Compression Test N62

The compression can be tested on the N62 using the DISplus. The DISplus can perform a relative compression test and provide a comprehensive engine analysis report.

The compression test can be done at minimum valve lift as well as at maximum valve lift. This difference between these reading can assist in determining the root cause such as wear in Valvetronic components.

When performing this test the following connections/cables are needed:

- Diagnostic head (can be hardwired or wireless)
- TD Cable connection to diagnostic head
- 25 Bar Pressure transducer connected to pressure connection #2.
- Compression adapter (quick disconnect)
- 1000 Amp clamp

The test module will prompt you to warm up the engine to 90°C. Once warmed up, you will be directed to run the engine at idle to set the minimum valve lift. Follow the on screen prompts. Once the minimum valve lift has been obtained (0.2 to 0.4 mm), disconnect both VVT motors to lock in the minimum adjustment.

Once this step is completed, shut the engine off and remove the #1 spark plug. Install the compression adapter into the spark plug hole. (Note: any cylinder can be used as long as the DISplus is set to the cylinder in use). Follow prompts until test is completed.



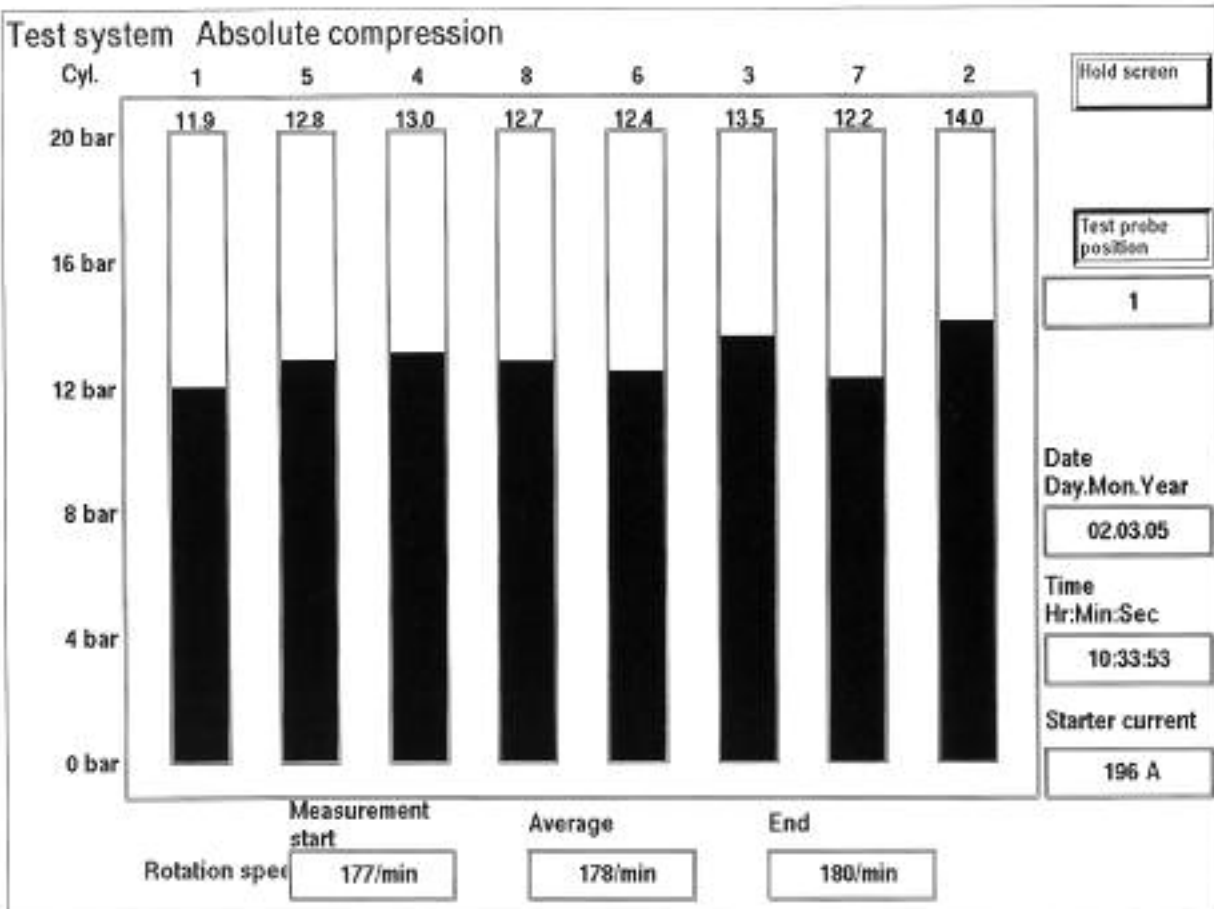

Once the test is completed, perform the same steps for the maximum valve lift. Compare the results, the results from the test at maximum valve lift should be slightly higher. Any cylinders that show low results on the minimum valve lift test which show improvements when the maximum valve lift test is performed should be checked for Valvetronic wear concerns.

During the final analysis portion of this test module, there may be on screen recommendations of repairs involving eccentric shaft or intermediate lever replacement. There may be a recommendation of changes to the classification of intermediate levers as well.

### Manual Compression Test (N62)

Manual compression testing can also be done on the N62. However, the DISplus must still be used to set the minimum/maximum valve lift. To access the test module for manual compression testing, go to path > Service Functions > Drive > Engine Management ME9 > Test Runs > Compression Test.

---

NOTES

PAGE



## Workshop Exercise - Engine Testing

*Using the DISplus and an instructor designated vehicle, perform the engine test using the MKA adapter.*

Vehicle: \_\_\_\_\_ Chassis # \_\_\_\_\_ Production Date: \_\_\_\_\_

DIS Software Version: \_\_\_\_\_

*Enter into test plan under - "Ignition and Injection diagnosis. Connect MKA adapter and follow on-screen instructions.*

What is the part number of the MKA adapter?

---

---

Which connectors on the ECM are connected to the MKA adapter?

---

---

What DIS test lead is used to connect to the MKA adapter?

---

---

*Start engine and warm up to operating temperature as per test module instructions.*

What are the results of the ignition and injection system testing?

---

---

---

*Once the MKA test module is complete, enter into "Compression Test" and follow on screen prompts.*

What test cables are needed for this test?

---

---

---

---

**Note: Be sure to connect battery charger during this test.**





## Workshop Exercise - Engine Testing

*Set valve lift to minimum adjustment for the first part of this test.*

What is the specified and actual valve lift observed on the test module screen?

---

---

*Unplug VVT motors when prompted before shutting engine off. Disable fuel supply and fuel injection when prompted. Remove spark plug from a cylinder which has easy access.*

Is it necessary to use only cylinder #1 during this test? Why or Why not?

---

---

*Continue to follow on screen prompts. Install pressure adapter into spark plug hole and connect amp clamp?*

What is the average compression results on all cylinders? Are there any cylinders which deviate excessively?

---

---

*At the end of the test module follow the on screen prompts. Restore engine to running condition in order to set maximum valve lift.*

*Perform compression test again, setting the engine to maximum valve lift when prompted.*

What is the result of the engine test with maximum valve lift? Are there any deviations between the readings between the two tests?

---

---

What would the deviations indicate?

---

---

Did the test module recommend any changes to the intermediate levers?

---

---



## Workshop Exercise - Engine Testing

*Enter into test plan for “Eccentric Shaft Adjustment”.*

What is the purpose of this test module?

---

---

---

What were the results of this test? (calibration angle etc.)

---

---

---

*Enter into the test module for “Irregular Operation Check” and follow on screen prompts.*

What is meant by “Irregular Operation Check” ?

---

---

---

Continue with test and record results below:

Cylinder	Standard Deviation	Mean Value
1		
2		
3		
4		
5		
6		
7		
8		



## Workshop Exercise - Engine Testing

What are the maximum allowable values during this test?

---

---

---

*Go to the test module for “intermediate lever wear” and follow the on screen prompts.  
Record the intermediate lever wear values in the table below:*

Cylinder >	1	2	3	4	5	6	7	8
Values >								

What is the maximum allowable value for eccentric shaft wear?

---

*Go to the test module for “Learning the stop positions” and follow the on screen prompts.*

What does this test module do? When should this test module be performed?

---

---

---

*Go to the test module for “Minimum Lift Adjustment” and follow the on screen prompts.*

What is the current minimum valve lift?

---

---

What is this test module used for?

---

---



## Classroom Exercise - Review Questions

1. What three fuel system components are responsible for maintain residual fuel pressure when the engine is off?

---

---

---

---

2. How many different classifications are available in the intermediate levers?

---

---

---

---

3. When connecting the MKA adapter, which ECM connectors are used?

---

---

---

---

4. What are “decay oscillations”?

---

---

---

---

5. Why is it important to test compression on the N62 at both minimum and maximum valve lift?

---

---

---

---

---

6. Why is it important to test fuel volume?

---

---

---

---

7. When using the DISplus test module to perform the compression test on the N62, can you use any cylinder other than one?

---

---

---

---

8. What is indicated when the additive mixture adaptation values are excessively positive? What are some of the causes of positive additive mixture adaptation values?

---

---

---

---

---

---