

Chapter 16

FIRECRAFT

16-1. Introduction:

a. The need for a fire should be placed high on the list of priorities. Fire is used for warmth, light, drying clothes, signaling, making tools, cooking, and water purification. When using fire for warmth, the body uses less calories for heat and consequently requires less food. Just having a fire to sit by is a morale booster. Smoke from a fire can be used to discourage insects.

b. Avoid building a very large fire. Small fires require less fuel, are easier to control, and their heat can be concentrated. Never leave a fire unattended unless it is banked or contained. Banking a fire is done by scraping cold ashes and dry earth onto the fire, leaving enough air coming through the dirt at the top to keep the fuel smoldering. This will keep the fire safe and allow it to be rekindled from the saved coals.

16-2. Elements of Fire:

a. The three essential elements for successful fire building are fuel, heat, and oxygen. These combined elements are referred to as the "fire triangle." By limiting fuel, only a small fire is produced. If the fire is not fed properly, there is too much or too little fire. Green fuel is difficult to ignite, and the fire must be burning well before it is used for fuel. Oxygen and heat must be accessible to ignite any fuel.

b. The survivor must take time and prepare well! Preparing all of the stages of fuel and all of the parts of the fire starting apparatus is the key. To be successful at firecraft, one needs to practice and be patient.

c. The fuels used in building a fire normally fall into three categories (figure 16-1), relating to their size and flash point: tinder, kindling, and fuel.

(1) Tinder is any type of small material having a low flash point. It is easily ignited with a minimum of heat, even a spark. Tinder must be arranged to allow air (oxygen) between the hair-like, bone-dry fibers. The preparation of tinder for fire is one of the most important parts of firecraft. Dry tinder is so critical that pioneers used extreme care to have some in a waterproof "tinder box" at all times. It may be necessary to have two or three stages of tinder to get the flame to a useful size. Tinders include:

- (a) The shredded bark from some trees and bushes.
- (b) Cedar, birch bark, or palm fiber.
- (c) Crushed fibers from dead plants.
- (d) Fine, dry woodshavings, and straw/grasses.
- (e) Resinous sawdust.
- (f) Very fine pitch woodshavings (resinous wood from pine or sappy conifers).
- (g) Bird or rodent nest linings.
- (h) Seed down (milkweed, cattail, thistle).

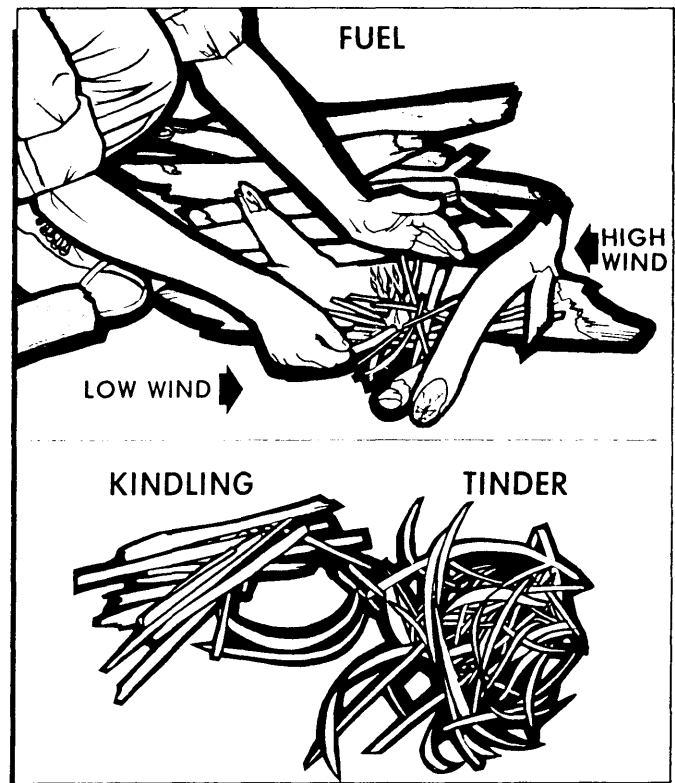

Figure 16-1. Stages of a Fire.

- (i) Charred cloth.
 - (j) Cotton balls or lint.
 - (k) Steel wool.
 - (l) Dry powdered sap from the pine tree family (also known as pitch).
 - (m) Paper.
 - (n) Foam rubber.
- (2) Kindling is the next larger stage of fuel material. It should also have a high combustible point. It is added to, or arranged over, the tinder in such a way that it ignites when the flame from the tinder reaches it. Kindling is used to bring the burning temperature up to the point where larger and less combustible fuel material can be used. Kindling includes:
- (a) Dead dry small twigs or plant fibers.
 - (b) Dead dry thinly shaved pieces of wood, bamboo, or cane (always split bamboo as sections can explode).
 - (c) Coniferous seed cones and needles.
 - (d) "Squaw wood" from the underside of coniferous trees; dead, small branches next to the ground sheltered by the upper live part of the tree.
 - (e) Pieces of wood removed from the insides of larger pieces.

(f) Some plastics such as the spoon from an in-flight ration.

(g) Wood which has been soaked or doused with flammable materials; that is, wax, insect repellent, petroleum fuels, and oil.

(h) Strips of petrolatum gauze from a first aid kit.

(i) Dry split wood burns readily because it is drier inside. Also the angular portions of the wood burn easier than the bark-covered round pieces because it exposes more surface to the flame. The splitting of all fuels will cause them to burn more readily.

(3) Fuel, unlike tinder and kindling, does not have to be kept completely dry as long as there is enough kindling to raise the fuel to a combustible temperature. It is recommended that all fine materials be protected from moisture to prevent excessive smoke production. (Highly flammable liquids should not be poured on an existing fire. Even a smoldering fire can cause the liquids to explode and cause serious burns.) The type of fuel used will determine the amount of heat and light the fire will produce. Dry split hardwood trees (oak, hickory, monkey pod, ash) are less likely to produce excessive smoke and will usually provide more heat than soft woods. They may also be more difficult to break into usable sizes. Pine and other conifers are fast-burning and produce smoke unless a large flame is maintained. Rotten wood is of little value since it smolders and smokes. The weather plays an important role when selecting fuel. Standing or leaning wood is usually dry inside even if it is raining. In tropical areas, avoid selecting wood from trees that grow in swampy areas or those covered with mosses. Tropical soft woods are not usually a good fuel source. Trial and error is sometimes the best method to determine which fuel is best. After identifying the burning properties of available fuel, a selection can be made of the type needed. Recommended fuel sources are:

(a) Dry standing dead wood and dry dead branches (those that snap when broken). Dead wood is easy to split and break. It can be pounded on a rock or wedged between other objects and bent until it breaks.

(b) The insides of fallen trees and large branches may be dry even if the outside is wet. The heart wood is usually the last to rot.

(c) Green wood which can be made to burn is found almost anywhere, especially if finely split and mixed evenly with dry dead wood.

(d) In treeless areas, other natural fuels can be found. Dry grasses can be twisted into bunches. Dead cactus and other plants are available in deserts. Dry peat moss can be found along the surface of undercut streambanks. Dried animal dung, animal fats, and sometimes even coal can be found on the surface. Oil impregnated sand can also be used when available.

16-3. Fire Location. The location of a fire should be carefully selected. An old story is told of a mountain

man who used his last match to light a fire built under a snow-covered tree. The heat from the fire melted the snow and it slid off the tree and put out the fire. For a survivor, this type of accident can be very demoralizing or even deadly. Locate and prepare the fire carefully.

16-4. Fire Site Preparation:

a. After a site is located, twigs, moss, grass, or duff should be cleaned away. Scrape at least a 3-foot diameter area down to bare soil for even a small fire. Larger fires require a larger area. If the fire must be built on snow, ice, or wet ground, survivors should build a platform of green logs or rocks. (Beware of wet or porous rocks, they may explode when heated.)

b. There is no need to dig a hole or make a circle of rocks in preparation for fire building. Rocks may be placed in a circle and filled with dirt, sand, or gravel to raise the fire above the moisture from wet ground. The purpose of these rocks is to hold the platform only.

c. To get the most warmth from the fire, it should be built against a rock or log reflector (figure 16-2). This will direct the heat into the shelter. Cooking fires can be walled-in by logs or stones. This will provide a platform for cooking utensils and serve as a windbreak to help keep the heat confined.

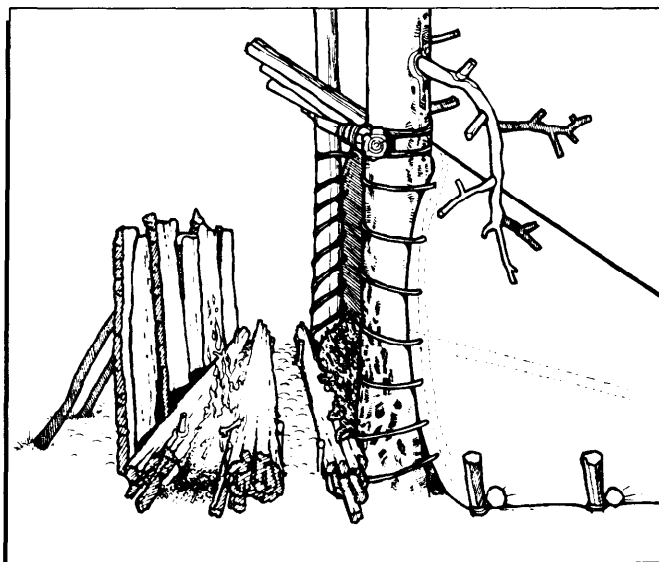

Figure 16-2. Fire Reflector.

d. After preparing the fire, all materials should be placed together and arranged by size (tinder, kindling, and fuel). As a rule of thumb, survivors should have three times the amount of tinder and kindling than is necessary for one fire. It is to their advantage to have too much than not enough. Having plenty of material on hand will prevent the possibility of the fire going out while additional material is gathered.

16-5. Firemaking With Matches (or Lighter):

a. Survivors should arrange a small amount of kindling in a low pyramid, close enough together so flames can jump from one piece to another. A small opening should be left for lighting and air circulation.

b. Matches can be conserved by using a "shave stick," or by using a loosely tied fagot of thin, dry twigs. The match must be shielded from wind while igniting the shave stick. The stick can then be applied to the lower windward side of the kindling.

c. Small pieces of wood or other fuel can be laid gently on the kindling before lighting or can be added as the kindling begins to burn. The survivors can then place smaller pieces first, adding larger pieces of fuel as the fire begins to burn. They should avoid smothering the fire by crushing the kindling with heavy wood.

d. Survivors only have a limited number of matches or other instant fire-starting devices. In a long-term situation, they should use these devices sparingly or carry fire with them when possible. Many primitive cultures carry fire (fire bundles) by using dry punk or fibrous barks (cedar) encased in a bark. Others use torches. Natural fire bundles also work well for holding the fire (figure 16-3).

e. The amount of oxygen must be just enough to keep the coals inside the dry punk burning slowly. This requires constant vigilance to control the rate of the burning process. The natural fire bundle is constructed in a cross section as shown in figure 16-3.

16-6. Heat Sources. A supply of matches, lighters, and other such devices will only last a limited time. Once the supply is depleted, they cannot be used again. If possible, before the need arises, survivors should be-

come skilled at starting fires with more primitive means, such as friction, heat, or a sparking device. It is essential that they continually practice these procedures. The need to start a fire may arise at the most inopportune times. One of the greatest aids a survivor can have for rapid fire starting is the "tinder box" previously mentioned. Using friction, heat, and sparks are very reliable methods for those who use them on a regular basis. Therefore, survivors must practice these methods. Survivors must be aware of the problems associated with the use of primitive heat sources. If the humidity is high in the immediate area, a fire may be difficult to ignite even if all other conditions are favorable. For primitive methods to be successful, the materials must be **BONE DRY**. The primitive people who use these ignition methods take great care to keep their tinder, kindling, and other fuels dry, even to the point of wrapping many layers of waterproof materials around it. *PREPARATION, PRACTICE, and PATIENCE* in the use of primitive fire-building techniques cannot be over emphasized. A key point in all primitive methods is to ensure that the tinder is not disturbed.

a. Flint and Steel:

(1) Flint and steel is one way to produce fire without matches.

(a) To use this method, survivors must hold a piece of flint in one hand above the tinder.

(b) Grasp the steel in the other hand and strike the flint with the edge of the steel in a downward glancing blow (figure 16-4).

(2) True flint is not necessary to produce sparks. Iron pyrite and quartz will also give off sparks even if they are struck against each other. Check the area and select the best spark-producing stone as a backup for the

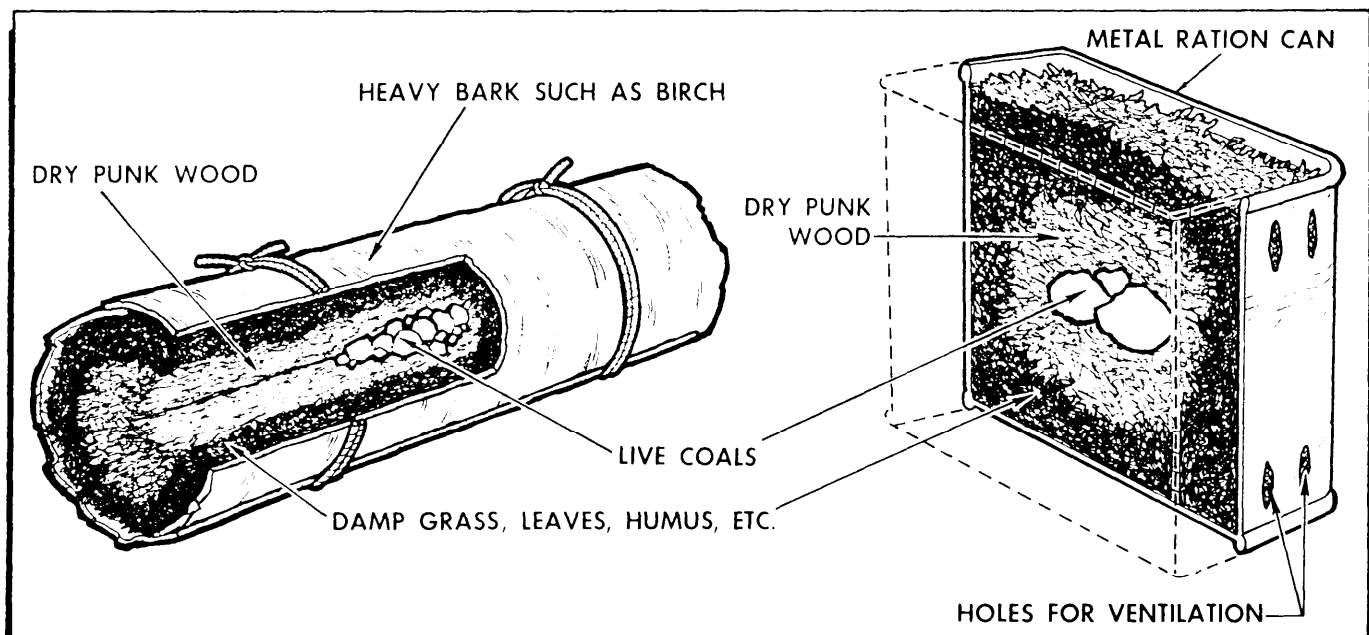

Figure 16-3. Fire Bundles.

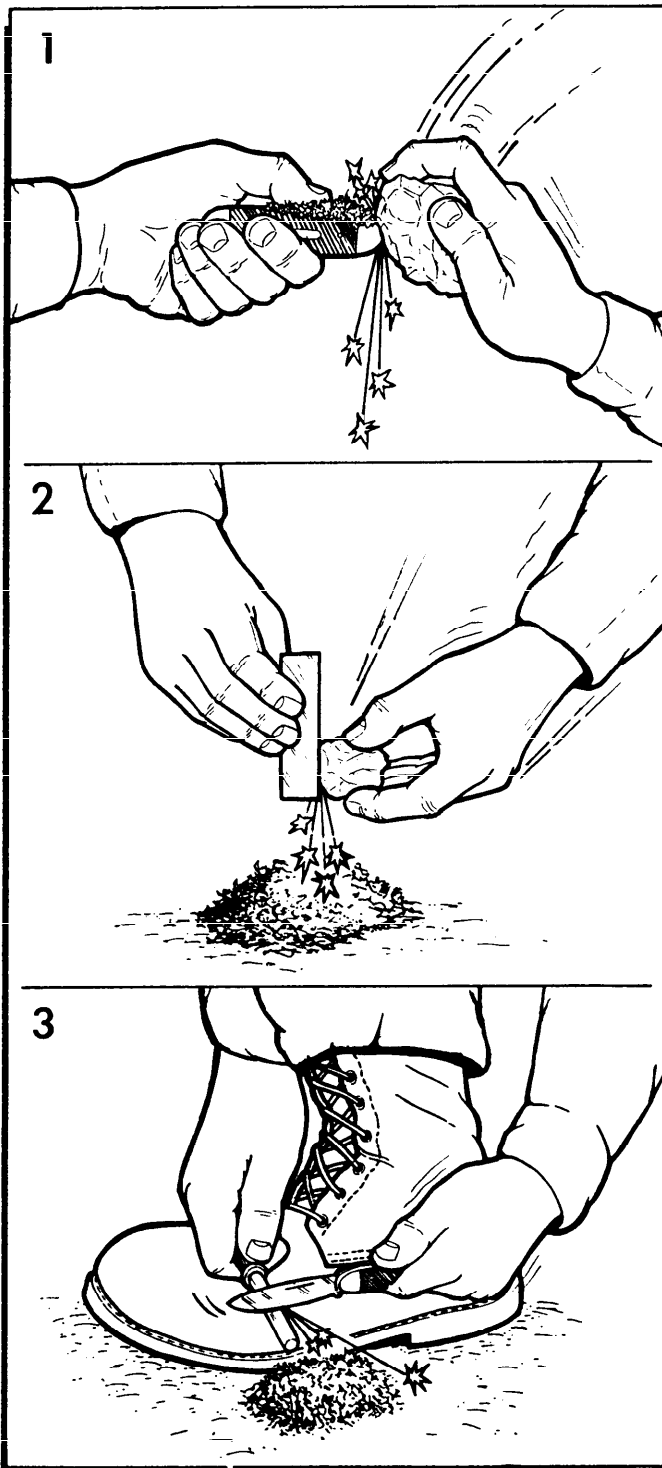

Figure 16-4. Fire Starting With Flint and Steel.

available matches. The sparks must fall on the tinder and then be blown or fanned to produce a coal and subsequent flame.

(3) Synthetic flint, such as the so-called metal match, consists of the same type material used for flints in commercial cigarette lighters. Some contain magnesi-

um which can be scraped into tinder and into which the spark is struck. The residue from the "match" burns hot and fast and will compensate for some moisture in tinder. If issued survival kits do not contain this item and the survivors choose to make one rather than buy it, lighter flints can be glued into a groove in a small piece of wood or plastic. The survivors can then practice striking a spark by scratching the flint with a knife blade. A 90-degree angle between the blade and flint works best. The device must be held close enough for the sparks to hit the tinder, but enough distance must be allowed to avoid accidentally extinguishing the fire. Cotton balls dipped in petroleum jelly make excellent tinder with flint and steel. When the tinder ignites, additional tinder, kindling, and fuel can be added.

b. Batteries:

(1) Another method of producing fire is to use the battery of the aircraft, vehicle, storage batteries, etc. Using two insulated wires, connect one end of a wire to the positive post of the battery and the end of the other wire to the negative post. Touch the two remaining ends to the ends of a piece of noninsulated wire. This will cause a short in the electrical circuit and the noninsulated wire will begin to glow and get hot. Material coming into contact with this hot wire will ignite. Survivors should use caution when attempting to start a fire with a battery. They should ensure that sparks or flames are not produced near the battery because explosive hydrogen gas is produced and can result in serious injury (figure 16-5).

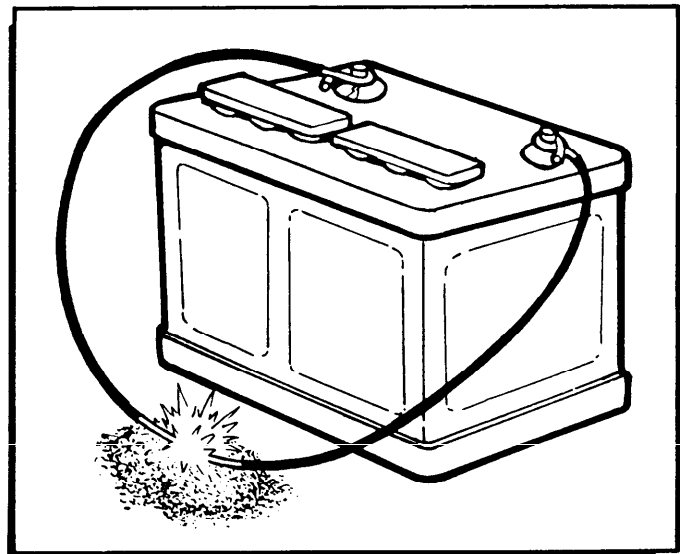

Figure 16-5. Fire Starting With Batteries.

(2) If fine grade steel wool is available, a fire may be started by stretching it between the positive and negative posts until the wire itself makes a red coal.

c. Burning Glass. If survivors have sunlight and a burning glass, a fire can be started with very little physical effort (figure 16-6). Concentrate the rays of the Sun on tinder by using the lens of a lensatic compass, a camera lens, or the lens of a flashlight which magnifies; even a convex piece of bottle glass may work. Hold the lens so that the brightest and smallest spot of concentrated light falls on the tinder. Once a whisp of smoke is produced, the tinder should be fanned or blown upon until the smoking coal becomes a flame. Powdered charcoal in the tinder will decrease the ignition time. Add kindling carefully as in any other type of fire. Practice will reduce the time it takes to light the tinder.

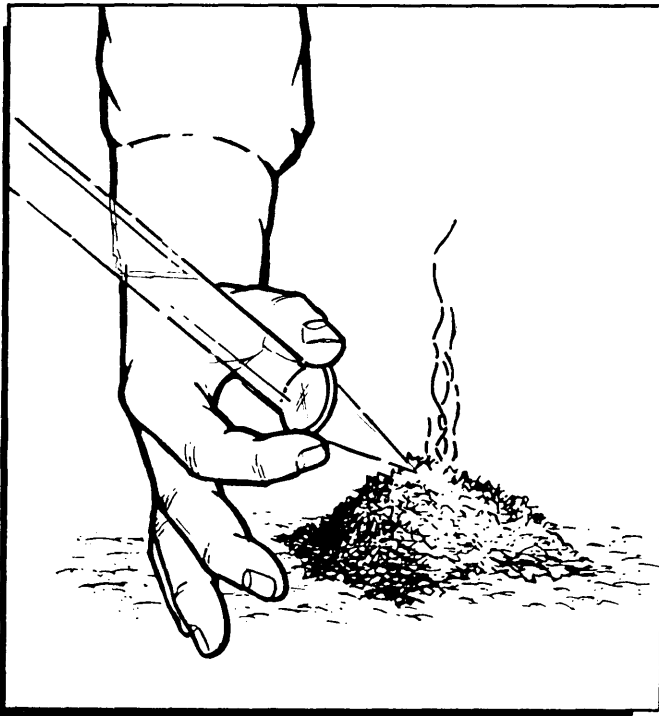

Figure 16-6. Fire Starting With Burning Glass.

d. Flashlight Reflector. A flashlight reflector can also be used to start a fire (figure 16-7). Place the tinder in the center of the reflector where the bulb is usually located. Push it up from the back of the hole until the hottest light is concentrated on the end and smoke results. If a cigarette is available, use it as a tinder for this method.

e. Bamboo Fire Saw:

(1) The bamboo fire saw is constructed from a section of dry bamboo with both end joints cut off. The section of bamboo, about 12 inches in length, is split in half lengthwise. The inner wall of one of the halves (called the "running board") is scraped or shaved thin. This is done in the middle of the running board. A notch to serve as a guide is cut in the outer sheath opposite the scraped area of the inner wall. This notch

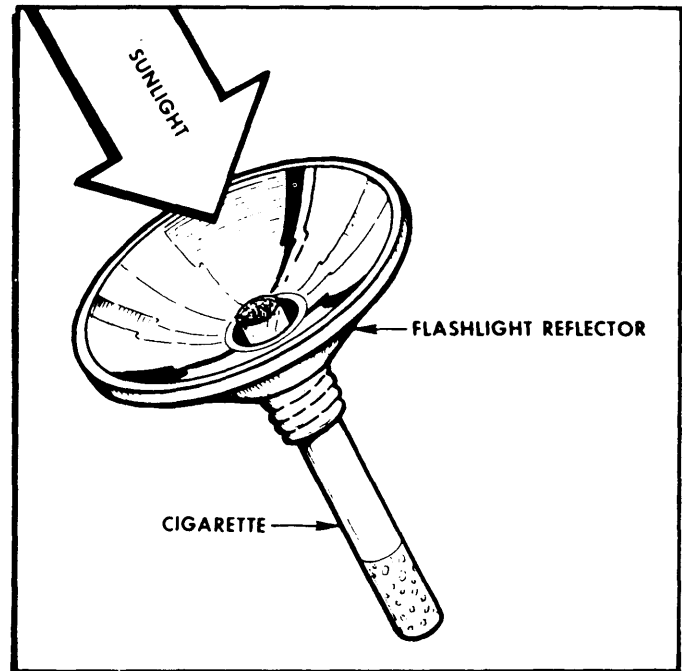

Figure 16-7. Fire Starting With Flashlight Reflector.

runs across the running board at a 90-degree angle (figure 16-8).

(2) The other half of the bamboo joint is further split in half lengthwise, and one of the resultant quarters is used as a "baseboard." One edge of the baseboard is shaved down to make a tapered cutting edge. The baseboard is then firmly secured with the cutting edge up. This may be done by staking it to the ground in any manner which does not allow it to move (figure 16-8).

(3) Tinder is made by scraping the outer sheath of the remaining quarter piece of the bamboo section. The scrapings (approximately a large handful) are then rubbed between the palms of the hands until all of the wood fibers are broken down and dust-like material no longer falls from the tinder. The ball of scrapings is then fluffed to allow maximum circulation of oxygen through the mass (figure 16-8).

(4) The finely shredded and fluffed tinder is placed in the running board directly over the shaved area, opposite the outside notch. Thin strips of bamboo should be placed lengthwise in the running board to hold the tinder in place. These strips are held stationary by the hands when grasping the ends of the running board (figure 16-8).

(5) A long, very thin sliver of bamboo (called the "pick") should be prepared for future use. One end of the running board is grasped in each hand, making sure the thin strips of bamboo are held securely in place. The running board is placed over the baseboard at a right angle, so that the cutting edge of the baseboard fits into

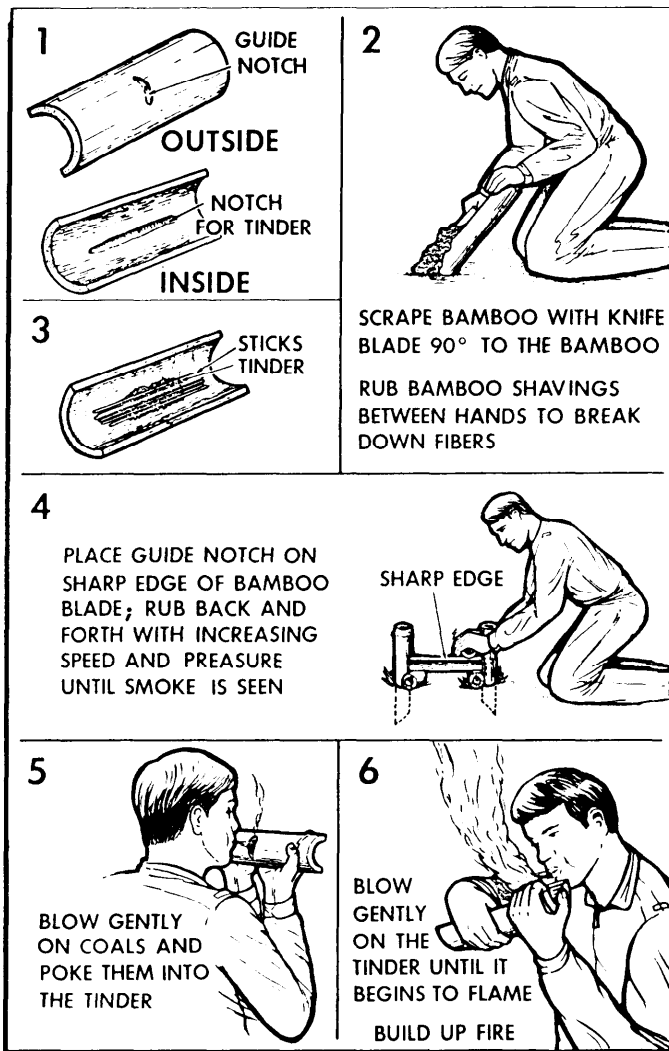

Figure 16-8. Bamboo Fire Saw.

the notch in the outer sheath of the running board. The running board is then slid back and forth as rapidly as possible over the cutting edge of the baseboard, with sufficient downward pressure to ensure enough friction to produce heat.

(6) As soon as "billows" of smoke rise from the tinder, the running board is picked up. The pick is used to push the glowing embers from the bottom of the running board into the mass of tinder. While the embers are being pushed into the tinder, they are gently blown upon until the tinder bursts into flame.

(7) As soon as the tinder bursts into flame, slowly add kindling in small pieces to avoid smothering the fire. Fuel is gradually added to produce the desired size fire. If the tinder is removed from the running board as soon as it flames, the running board can be reused by cutting a notch in the outer sheath next to the original notch and directly under the scraped area of the inner wall.

f. Bow and Drill:

(1) This is a friction method which has been used successfully for thousands of years. A spindle of yucca, elm, basswood, or any other straight grainwood (not softwood) should be made. The survivors should make sure that the wood is not too hard or it will create a glazed surface when friction is applied. The spindle should be 12 to 18 inches long and three-fourths inch in diameter. The sides should be octagonal, rather than round, to help create friction when spinning. Round one end and work the other end into a blunt point. The round end goes to the top upon which the socket is placed. The socket is made from a piece of hardwood large enough to hold comfortably in the palm of the hand with the curved part up and the flat side down to hold the top of the spindle. Carve or drill a hole in this side and make it smooth so it will not cause undue friction and heat production. Grease or soap can be placed in this hole to prevent friction (figure 16-9).

(2) The bow is made from a stiff branch about 3 feet long and about 1 inch in diameter. This piece should have sufficient flexibility to bend. It is similar to a bow used to shoot arrows. Tie a piece of suspension line or leather thong to both ends so that it has the same tension as that of a bow. There should be enough tension for the spindle to twist comfortably.

(3) The fireboard is made of the softwood and is about 12 inches long, three-fourths inch thick, and 3 to 6 inches wide. A small hollow should be carved in the fireboard. A V-shaped cut can then be made in from the edge of the board. This V-shape should extend into the center of the hollow where the spindle will make the hollow deeper. The object of this "V" cut is to create an angle which cuts off the edge of the spindle as it gets hot and turns to charcoal dust. This is the critical part of the fireboard and must be held steady during the operation of spinning the spindle.

(4) While kneeling on one knee, the other foot can be placed on the fireboard as shown in figure 16-9 and the tinder placed under the fireboard just beneath the V-cut. Care should be taken to avoid crushing the tinder under the fireboard. Space can be obtained by using a small, three-fourths inch diameter stick to hold up the fireboard. This allows air into the tinder where the hot powder (spindle charcoal dust) is collected.

(5) The bow string should be twisted once around the spindle. The spindle can then be placed upright into the spindle hollow (socket). The survivor may press the socket down on the spindle and fireboard. The entire apparatus must be held steady with the hand on the socket braced against the leg or knee. The spindle should begin spinning with long even slow strokes of the bow until heavy smoke is produced. The spinning should become faster until the smoke is very thick. At this point, hot powder, that can be blown into a glowing ember, has been successfully produced. The bow and spindle can then be removed from the fireboard and the

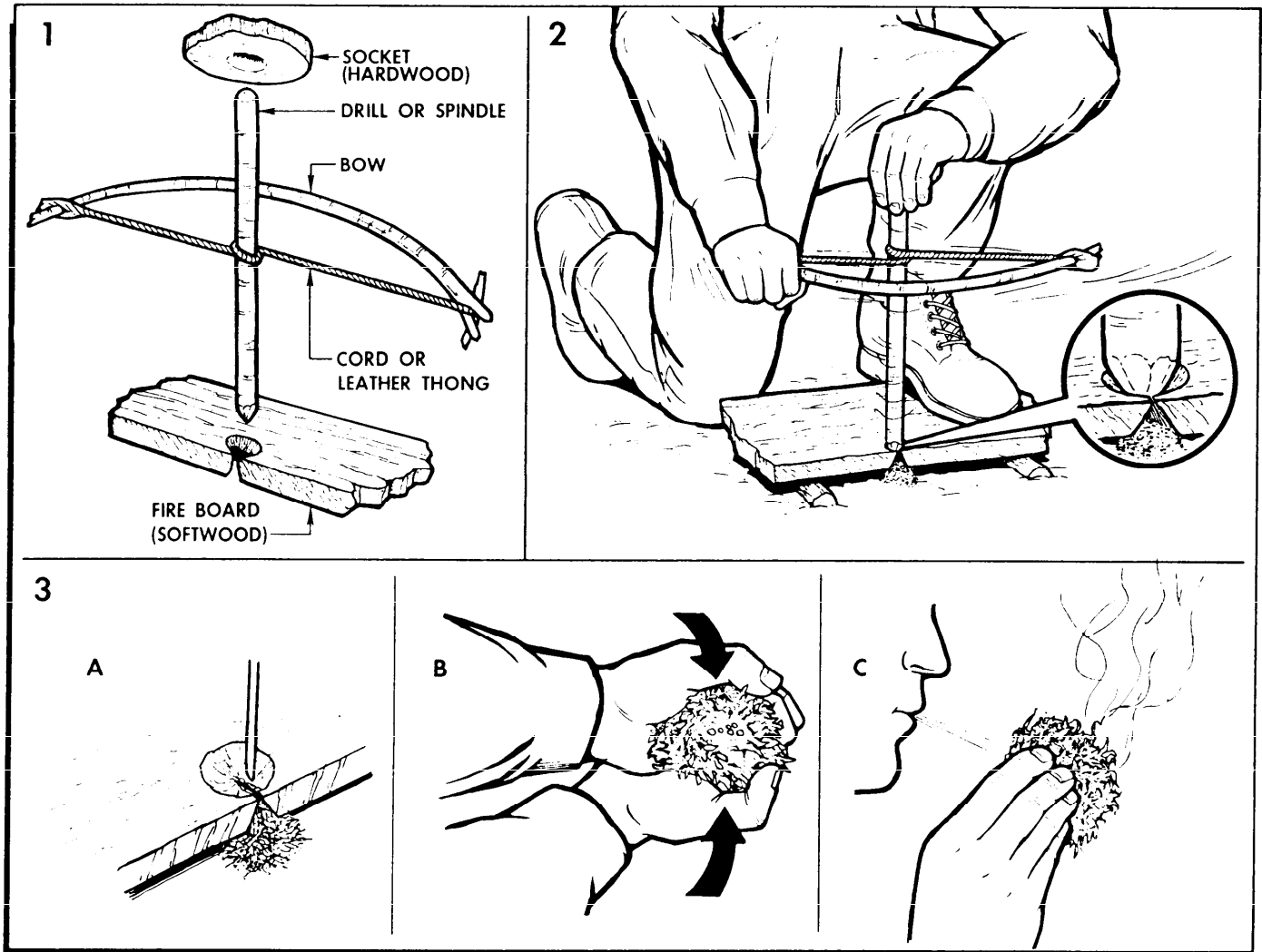

Figure 16-9. Bow and Drill.

tinder can be placed next to the glowing ember making sure not to extinguish it. The tinder must then be rolled gently around the burning ember, and blow into the embers, starting the tinder to burn. This part of the fire is most critical and should be done with care and planning.

(6) The burning tinder is then placed into the waiting fire "lay" containing more tinder and small kindling. At no time in this process should the survivor break concentration or change sequence. The successful use of these primitive methods of fire starting will require a great deal of patience. Success demands dedication and practice.

g. The Fire Thong. The fire thong, another friction method, is used in only those tropical regions where rattan is found. The system is simple and consists of a twisted rattan thong or other strong plant fiber, 4 to 6 feet long, less than 1 inch in diameter, and a 4-foot length of dry wood which is softer than rattan

(dedicuous wood) (figure 16-10). Rub with a steady but increasing rhythm.

h. The Plow. The plow is a method used by some primitives and basically follows the principles of other friction methods. The wood used must not glaze with heat applied and must be able to produce powder with friction.

i. Ground Stake. Another variation can be constructed by driving a stake into the ground as shown in figure 16-11.

16-7. Firemaking With Special Equipment:

a. The night end of the day-night flare can be used as a fire starter. This means, however, that survivors must weigh the importance of a fire against the loss of a night flare.

b. Some emergency kits contain small fire starters, cans of special fuels, windproof matches, and other aids.



Figure 16-10. Fire Thong.

Survivors should save the fire starters for use in extreme cold and damp (moist) weather conditions.

c. The white plastic spoon (packed in various in-flight rations) may be the type that burns readily. The handle should be pushed deep enough into the ground to support the spoon in an upright position. Light the tip of the spoon. It will burn for about 10 minutes (long enough to dry out and ignite small tinder and kindling).

d. If a candle is available, it should be ignited to start a fire and thus prevent using more than one match. As soon as the fire is burning, the candle can be extinguished and saved for future use.

e. Tinder can be made more combustible by adding a few drops of flammable fuel/material. An example of this would be mixing the powder from an ammunition cartridge with the tinder. After preparing tinder in this manner, it should be stored in a waterproof container for future use. Care must be used in handling this mixture because the flash at ignition could burn the skin and clothing.

f. For thousands of years, the Eskimos and other northern peoples have relied heavily upon oils from animals to heat their homes. A fat stove or "Koodlik" is used by the Eskimos to burn this fuel.

g. Survivors can improvise a stove from a ration can and burn any flammable oil-type liquid or animal fats available. Here again, survivors should keep in mind that if there is only a *limited* amount of animal fat, it should be eaten to produce heat inside the body.

16-8. Burning Aircraft Fuel. On barren lands in the arctic, aircraft fuel may be the only material survivors have available for fire.

a. A stove can be improvised to burn fuel, lubricating oil, or a mixture of both (figure 16-12). The survivor should place 1 or 2 inches of sand or fine gravel in the bottom of a can or other container and add fuel. *Care should be used when lighting the fuel because it may explode.* Slots should be cut into the top of the can to let flame and smoke out, and holes punched just above the level of the sand to provide a draft. A mixture of fuel and oil will make the fire burn longer. If no can is available, a hole can be dug and filled with sand. Fuel is then poured on the sand and ignited. The survivor should not allow the fuel to collect in puddles.

b. Lubricating oil can be burned as fuel by using a wick arrangement. The wick can be made of string, rope, rag, sphagnum moss, or even a cigarette and should be placed on the edge of a receptacle filled with oil. Rags, paper, wood, or other fuel can be soaked in oil and thrown on the fire.

c. A stove can be made of any empty waxed carton by cutting off one end and punching a hole in each side near the unopened end. Survivors can stand the carton on the closed end and loosely place the fuel inside the carton. The stove can then be lit using fuel material left hanging over the end. The stove will burn from the top down.

d. Seal blubber makes a satisfactory fire without a container if gasoline or heat tablets are available to provide an initial hot flame (figure 16-13). The heat source should be ignited on the raw side of the blubber while the fur side is on the ice. A square foot of blubber burns for several hours. Once the blubber catches fire, the heat tablets can be recovered. Eskimos light a small piece of blubber and use it to kindle increasingly larger pieces. The smoke from a blubber fire is dirty, black, and heavy. The flame is very bright and can be seen for several miles. The smoke will penetrate clothing and blacken the skin.

16-9. Useful Firecraft Hints:

a. Conserve matches by only using them on properly prepared fires. They should never be used to light cigarettes or for starting unnecessary fires.

b. Carry some dry tinder in a waterproof container. It should be exposed to the Sun on dry days. Adding a little powdered charcoal will improve it. Cotton cloth is good tinder, especially if scorched or charred. It works well with a burning glass or flint and steel.

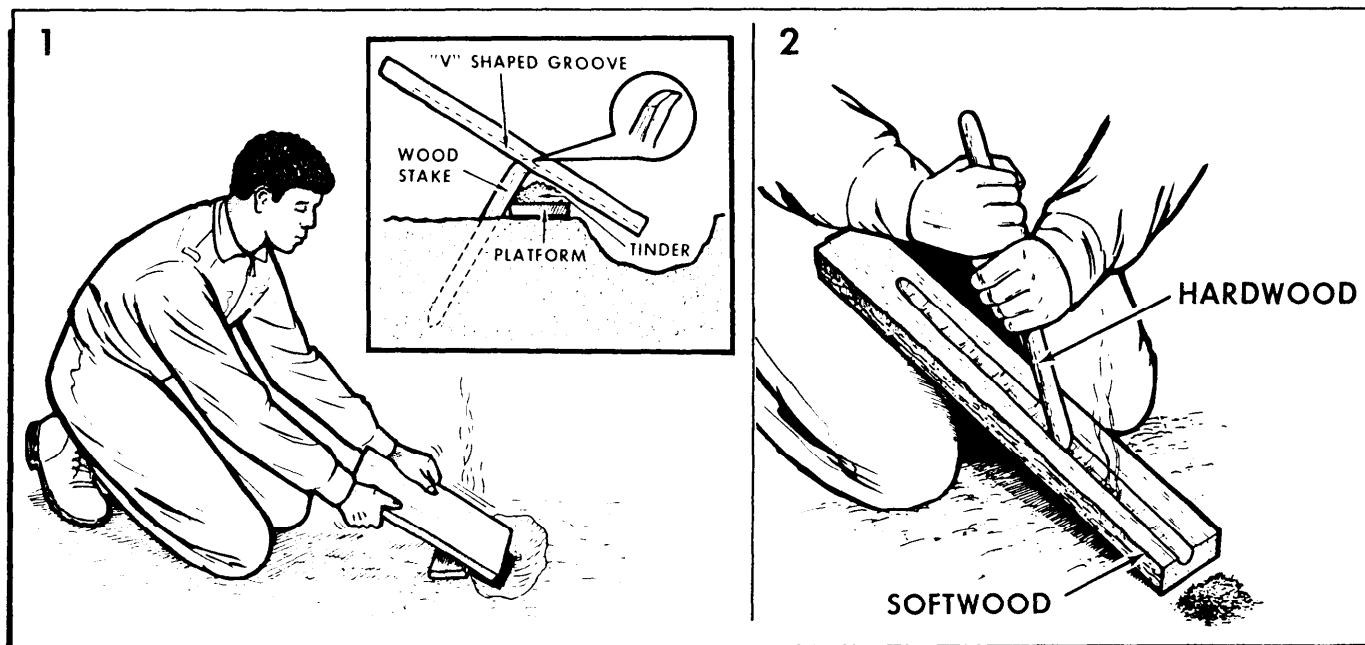

Figure 16-11. Fire Plow.

c. Remember that firemaking can be a difficult job in an arctic environment. The main problem is the availability of firemaking materials. Making a fire starts *WELL* before the match is lit. The fire must be protected from the wind. In wooded areas, standing timber and brush usually make a good windbreak but in open areas, some type of windbreak may have to be constructed. A row of snowblocks, the shelter of a ridge, or a pile of brush will work as a windbreak. It must be high enough to shield the fire from the wind. It may also act as a heat reflector if it is of solid material.

d. Remember, a platform will be required to prevent the fire from melting down through the deep snow and extinguishing it. A platform is also needed if the ground is moist or swampy. The platform can be made of green logs, metal, or any material that will not burn through very readily. Care must be taken when selecting an area for fire building. If the area has a large accumulation of humus material and (or) peat, a platform is needed to avoid igniting the material as it will tend to smolder long after the flames of the fire are extinguished. A smoldering peat fire is almost impossible to put out and may burn for years.

e. In forested areas, the debris on the ground and the lichen mat should be cleared away to mineral soil, if possible, to prevent the fire from spreading.

f. The ignition source used to ignite the fire must be quick and easily operated with hand protection such as mittens. Any number of devices will work well—matches, candle, lighter, fire starter, metal matches, etc.

16-10. Fire Lays. Most fires are built to meet specific needs or uses, either heat, light, or preparing food and water. The following configurations are the most commonly used for fires and serve one or more needs (figure 16-14).

a. Tepee:

(1) The tepee fire can be used as a light source and has a concentrated heat point directly above the apex of the tepee which is ideal for boiling water. To build:

(a) Place a large handful of tinder on the ground in the middle of the fire site.

(b) Push a stick into the ground, slanting over the tinder.

(c) Then lean a circle of kindling sticks against the slanting stick, like a tepee, with an opening toward the windward side for draft.

(2) To light the fire:

(a) Crouch in front of the fire lay with the back to the wind.

(b) Feed the fire from the downwind side, first with thin pieces of fuel, then gradually with thicker pieces.

(c) Continue feeding until the fire has reached the desired size. The tepee fire has one big drawback. It tends to fall over easily. However, it serves as an excellent starter fire.

b. Log Cabin. As the name implies, this lay looks similar to a log cabin. Log cabin fires give off a great amount of light and heat primarily because of the amount of oxygen which enters the fire. The log cabin

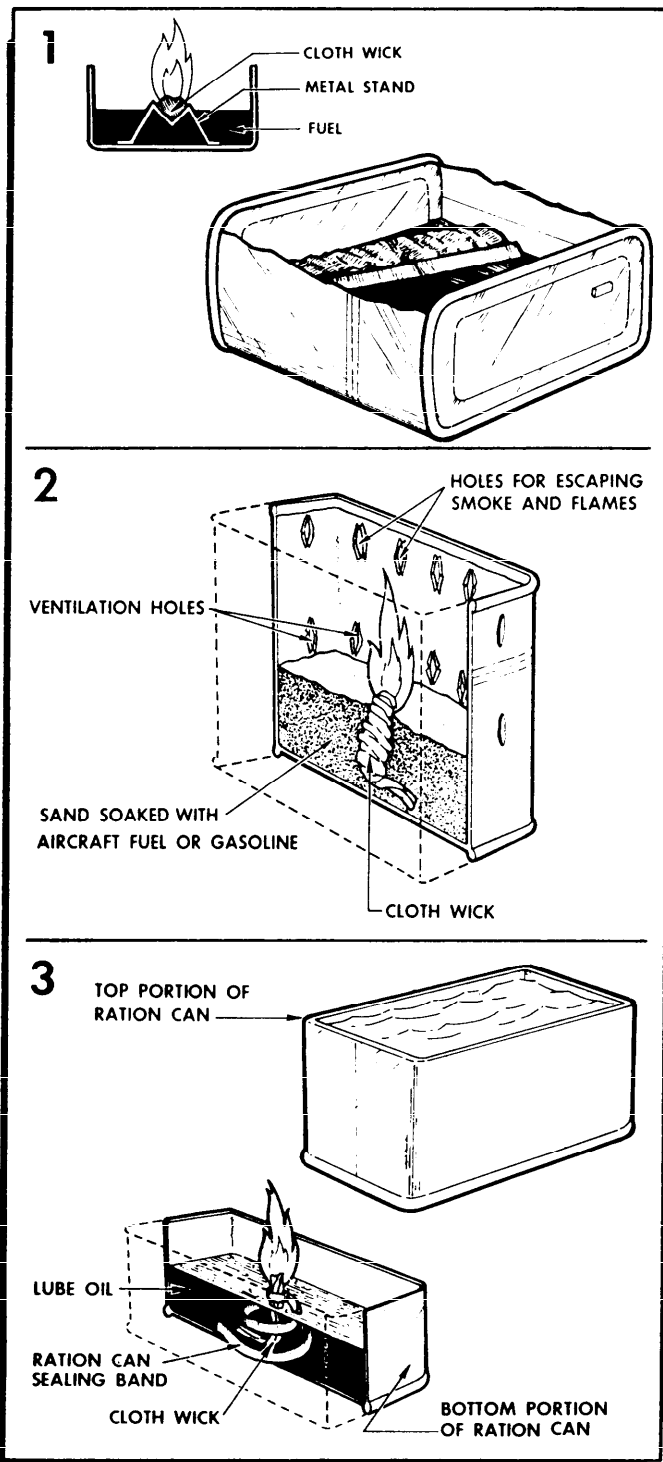

Figure 16-12. Fat and Oil Stoves.

fire creates a quick and large bed of coals and can be used for cooking or as the basis for a signal fire. If one person or a group of people are going to use the coals for cooking, the log cabin can be modified into a long fire or a keyhole fire.

c. Long Fire. The long fire begins as a trench, the length of which is layed to take advantage of existing

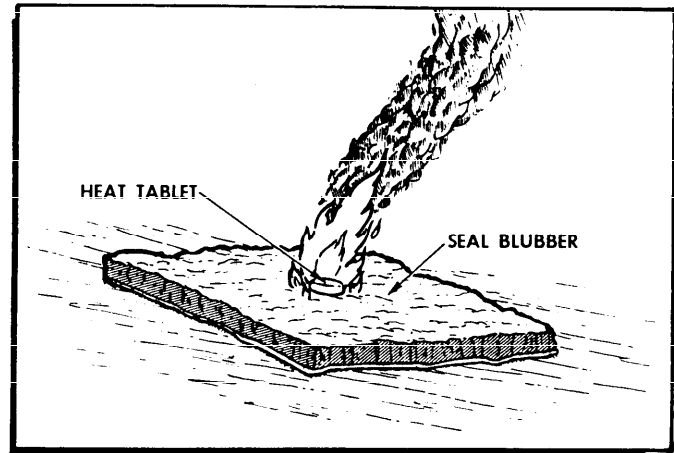

Figure 16-13. Heat Tablet/Seal Blubber

wind. The long fire can also be built above ground by using two parallel green logs to hold the coals together. These logs should be at least 6 inches in diameter and situated so the cooking utensils will rest upon the logs. Two 1-inch thick sticks can be placed under both logs, one at each end of the long fire. This is done to allow the coals to receive more air.

d. Keyhole Fire. To construct a keyhole fire, a hole is dug in the shape of an old style keyhole and does the same thing as the long fire.

e. Pyramid Fire. The pyramid fire looks similar to a log cabin fire except there are layers of fuel in place of a hollow framework. The advantage of a pyramid fire is that it burns for a long time resulting in a large bed of coals. This fire could possibly be used as an overnight fire when placed in front of a shelter opening.

f. Star Fire. This fire is used when conservation of fuel is necessary or a small fire is desired. It burns at the center of the "wheel" and must be constantly tended. Hardwood fuels work best with this type of fire.

g. "T" Fire. Used for large group cooking. The size of this lay may be adjusted to meet the group's cooking needs. In the top part of the "T," the fire is constructed and maintained as long as needed to provide hot coals for cooking in the bottom part of the "T" fire lay. The number of hot coals may be adjusted in the lower part of the "T" fire lay to regulate the cooking temperature.

h. "V" Fire. This fire lay is a modification of the long fire. The configuration allows a survivor to either block strong winds, or take advantage of light breezes. During high wind conditions, the vertex of the "V"—formed by the two outside logs—is placed in the direction from which the winds are coming, thereby sheltering the tinder (kindling) for ignition. Reversing the "lay" will funnel light breezes into the tinder (kindling) thereby facilitating ease of ignition (figure 16-1).

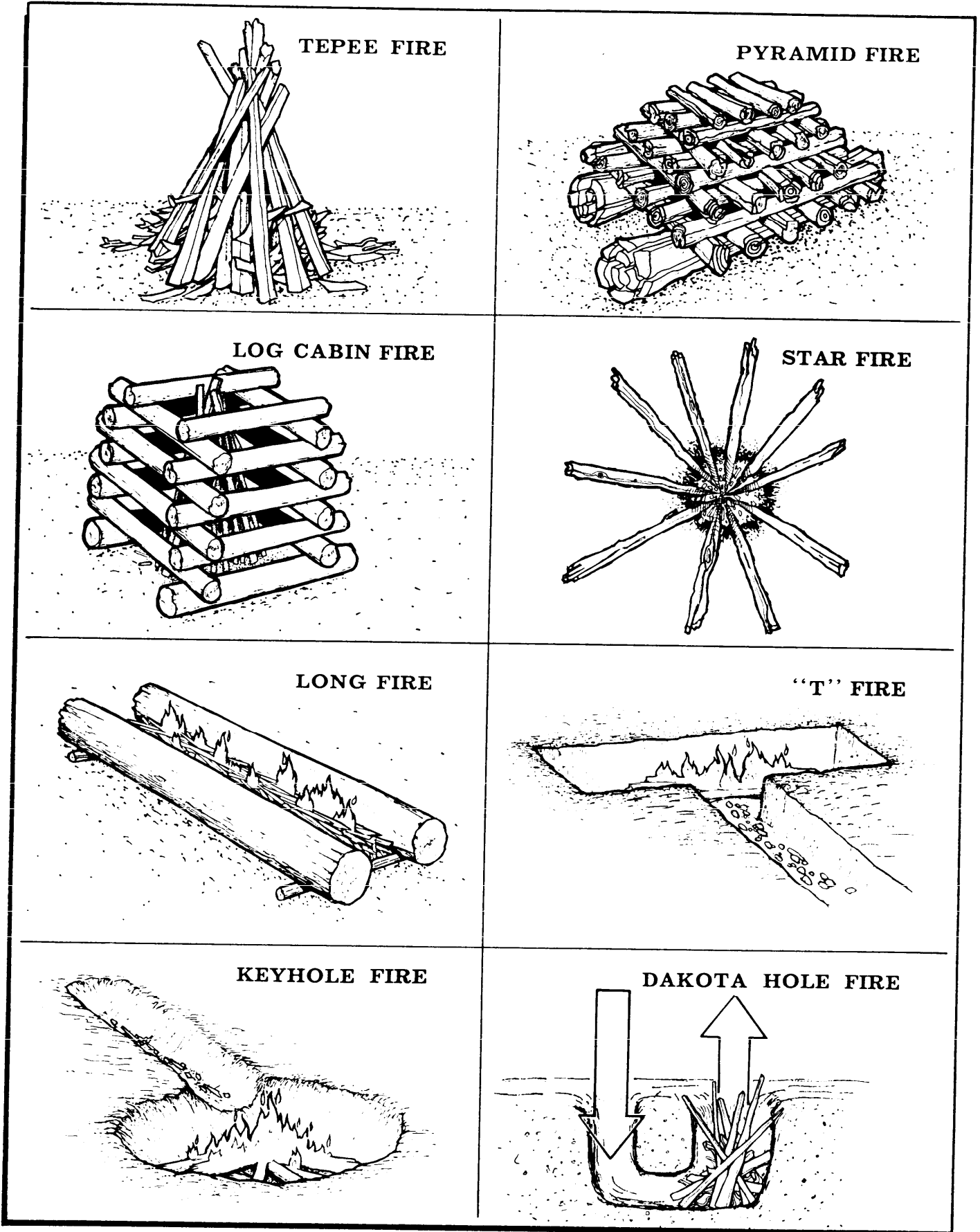

Figure 16-14. Fire Lays.

Chapter 17

EQUIPMENT

17-1. Introduction. Survivors in a survival situation have needs which must be met—food, water, clothing, shelters, etc. The survival kit contains equipment which can be used to satisfy these needs. Quite often, however, this equipment may not be available due to damage or loss. This chapter will address the care and use of issued equipment and improvising the needed equipment when not available. The uses of some issued items are covered in appropriate places throughout this regulation. The care and use of equipment (not covered elsewhere) will be addressed here.

17-2. Types of Kits:

a. All survival kits contain two types of equipment—mandatory and optional. The mandatory equipment for survival kits are:

- (1) One-man liferaft (1 each).
- (2) Compass (1 each).
- (3) Smoke and illumination flares (2 each).
- (4) Signal mirror (1 each).
- (5) Hand-held launched flare (1 each).
- (6) First aid kit (1 each).
- (7) Survival radio (1 each).

NOTE: These items of equipment may not be mandatory for raft kit.

b. Optional items are authorized by the major air commands; this authority is delegated to subordinate commanders. These optional items are directly related to climatic conditions and the type of terrain which is being flown over. There are over 40 optional items. Here are a few examples:

- (1) Sleeping bag.
- (2) Strobelight with lenses.
- (3) Wire saw.
- (4) Water container.
- (5) Survival shovel.
- (6) Matchbox container.

17-3. Issued Equipment. Survival equipment is designed to aid survivors throughout their survival episode. To maintain its effectiveness, the equipment must be well cared for.

a. Electronic Equipment:

(1) Electronic signaling devices are by far the survivors' most important signaling devices. Therefore, it is important for survivors to properly care for them to ensure their continued effectiveness. In cold temperatures, the electronic signaling devices must be kept warm to prevent the batteries from becoming cold soaked.

(2) In a cold environment, if survivors speak directly into the microphone, the moisture from their breath

may condense and freeze on the microphone, creating communication problems.

(3) Caution must be used when using the survival radios in a cold environment. If the radio is placed against the side of the face to communicate, frostbite could result.

(4) In a wet environment, survivors should make every effort to keep their electronic signaling devices dry. In an open-sea environment, the only recourse may be to shake the water out of the microphone before transmitting.

b. Firearms:

(1) A firearm is a precision tool. It will continue functioning only as long as it is cared for. Saltwater, perspiration, dew, and humidity can all corrode or rust a firearm until it is inoperable. If immersed in saltwater, the survivor should wash the parts in freshwater and then dry and oil them. As an expedient, one way to dry the firearm is to place it in boiling water and after removal, wipe off the excess moisture. The residual heat will evaporate most of the remaining moisture. Survivors should not use uncontrolled heat to dry the firearm as heat over 250°F can remove the temper from the springs in a short time and weaken the action.

(2) Any petroleum-based lubricants used in cold environments will stiffen or freeze causing the firearm to become inoperative. It would be better to thoroughly clean the firearm and remove all lubricant. Metal becomes brittle from cold and is, therefore, prone to breakage.

(3) A firearm was not intended for use as a club, hammer, or pry bar. To use it for any purpose other than for which it was designed, would only result in damage to the firearm.

c. Cutting Tools:

(1) A file and sharpening stone are often packed in a survival kit. The file is normally used for axes, and the stone is normally used for knives.

(2) An old axiom states that a sharp cutting tool is a safe cutting tool. Control of a cutting tool is easier to maintain if it is sharp, and the possibility of accidental injury is reduced.

(3) One of the most valuable items in any survival situation is a knife, since it has a large number of uses. Unless the knife is kept sharp, however, it falls short of its potential.

(4) A knife should be sharpened only with a stone as repeated use of a file rapidly removes steel from the blade. In some cases, it may be necessary to use a file to remove plating from the blade before using the stone.

(5) One of two methods should be used to sharpen a knife. One method is to push the blade down the stone

in a slicing motion. Then turn the blade over and draw the blade toward the body (figure 17-1).

(6) The other method is to use a circular motion the entire length of the blade; turn the blade over and repeat

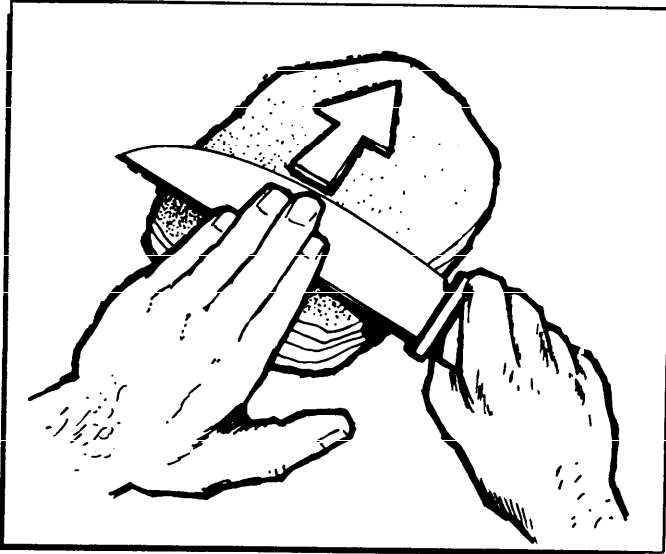

Figure 17-1. Knife Sharpening (Draw).

the process. What is done to one side of the cutting edge should also be done to the other to maintain an even cutting edge (figure 17-2).

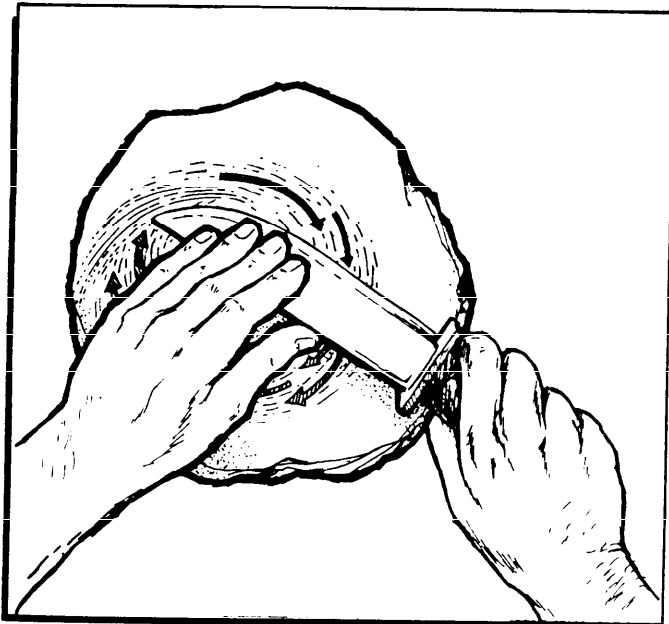

Figure 17-2. Knife Sharpening (Circular).

(7) Most sharpening stones available to survivors will be whetstones. Water should be applied to these stones. The water will help to float away the metal re-

moved by sharpening and make cleaning of the stone easier.

(8) If a commercial whetstone is not available, a natural whetstone can be used. Any sandstone will sharpen tools, but a gray, clay-like sandstone gives better results. Quartzite should be avoided. Survivors can recognize quartzite instantly by scratching the knife blade with it—the quartz crystals will bite into steel. If no sandstone is available, granite or crystalline rock can be used. If granite is used, two pieces of the stone should be rubbed together to smooth the surface before use.

(9) As with a knife, a sharp axe will save time and energy and be much safer.

(10) A file should be used on an axe or hatchet. Survivors should file away from the cutting edge to prevent injury if the file should slip. The file should be worked from one end of the cutting edge to the other. The opposite side should be worked to the same degree. This will ensure that the cutting edge is even. After using a file, the stone may be used to hone the axe blade (figure 17-3).

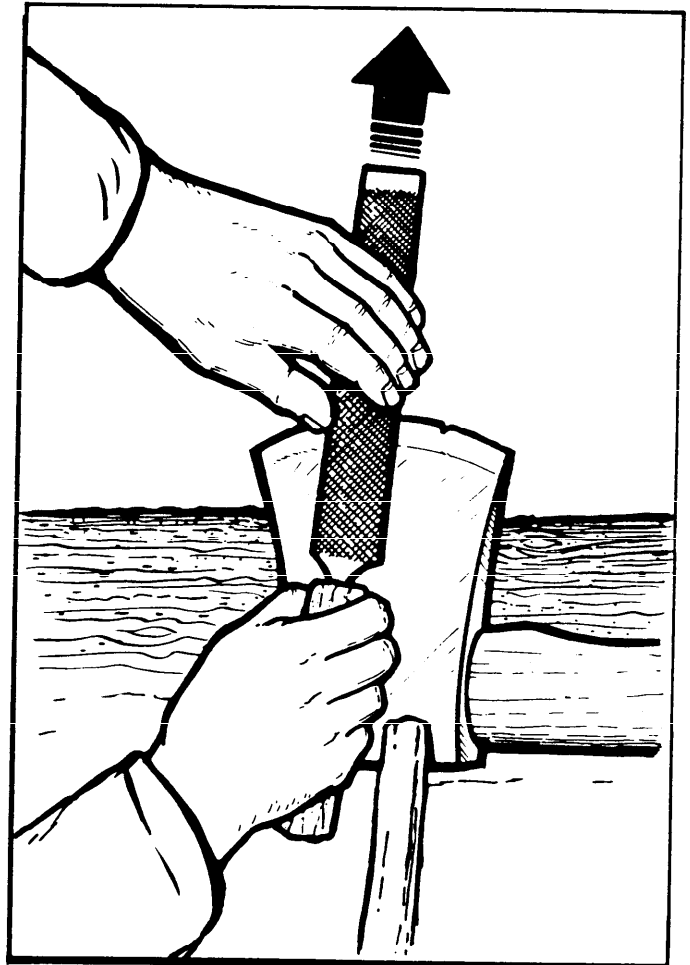

Figure 17-3. Sharpening Axe.

(11) When using an axe, don't try to cut through a tree with one blow. Rhythm and aim are more important than force. Too much power behind a swing interferes with aim. When the axe is swung properly, its weight provides all the power needed.

(12) Carving a new axe handle and mounting the axe head takes a great deal of time and effort. For this reason, a survivor should avoid actions which would require the handle to be changed. Using aim and paying attention to where the axe falls will prevent misses which could result in a cracked or broken handle. Survivors should not use an axe as a pry bar and should avoid leaving the axe out in cold weather where the handle may become brittle.

(13) A broken handle is difficult to remove from the head of the axe. Usually the most convenient way is to burn it out (figure 17-4). For a single-bit axe, bury the bit in the ground up to the handle, and build a fire over it. For a double-bit, a survivor should dig a small trench, lay the middle of the axe head over it, cover both "bits" with earth, and build the fire. The covering of earth keeps the flame from the cutting edge of the axe and saves its temper. A little water added to the earth will further ensure this protection.

(14) When improvising a new handle, a survivor can save time and trouble by making a straight handle instead of a curved one like the original. Survivors should use a young, straight piece of hardwood without knots. The wood should be whittled roughly into shape and finished by shaving. A slot should be cut into the axe-head end of the handle. After it is fitted, a thin, dry wooden wedge can then be pounded into the slot. Survivors should use the axe awhile, pound the wedge in again, then trim it off flush with the axe. The handle must be smoothed to remove splinters. The new handle can be seasoned to prevent shrinkage by "scorching" it in the fire.

d. Whittling:

(1) Whittle means to cut, trim, or shape (a stick or piece of wood) by taking off bits with a knife. Survivors should be able to use the techniques of whittling to help save time, energy, and materials as well as to prevent injuries. They will find that whittling is a necessity in constructing triggers for traps and snares, shuttles and spacers, and other improvised equipment.

(2) When whittling, survivors must hold the knife firmly and cut away from the body (figure 17-5). Wood should be cut with the grain. Branches should be trimmed as shown in figure 17-6.

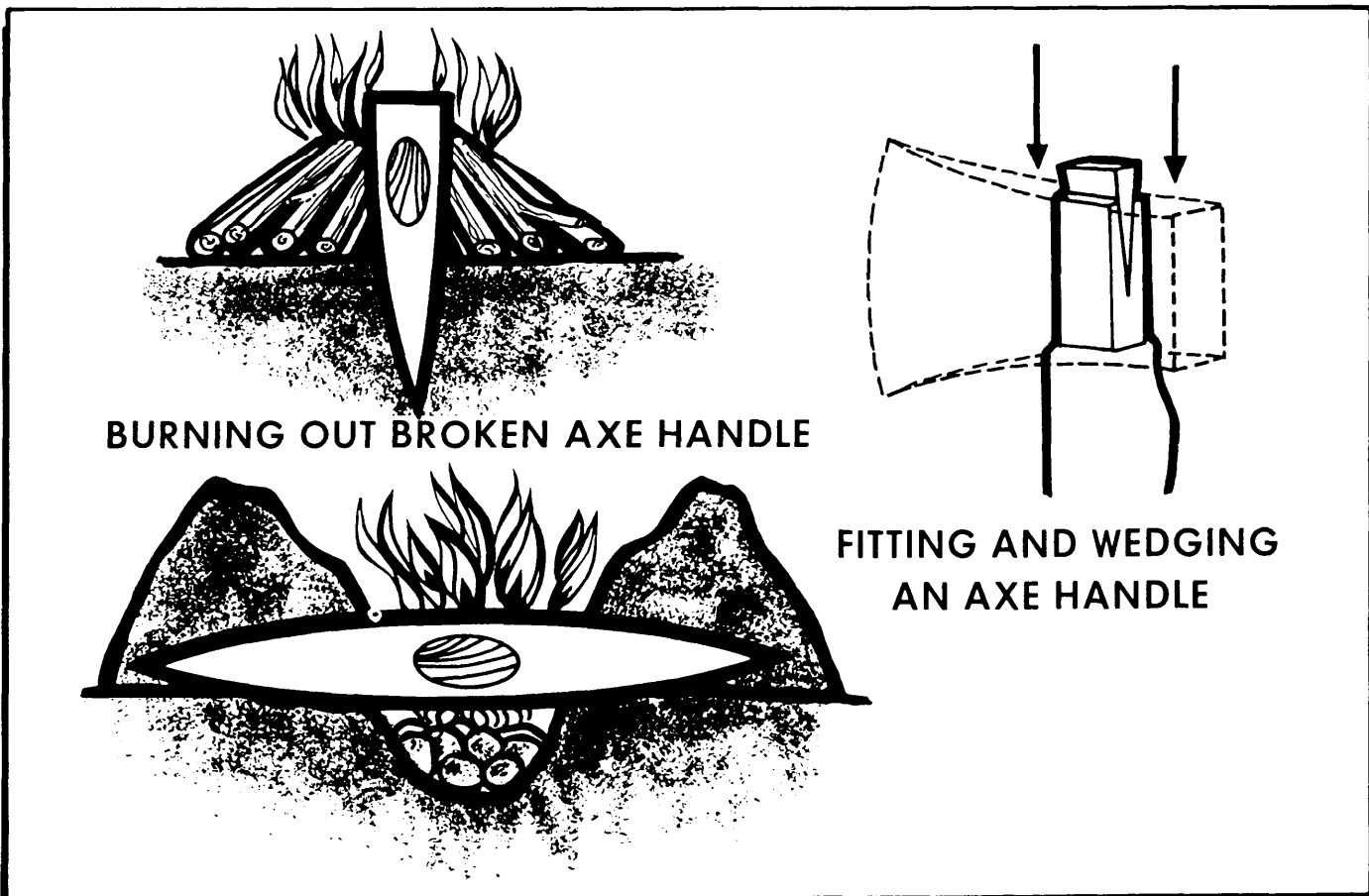

Figure 17-4. Removing Broken Axe Handle.

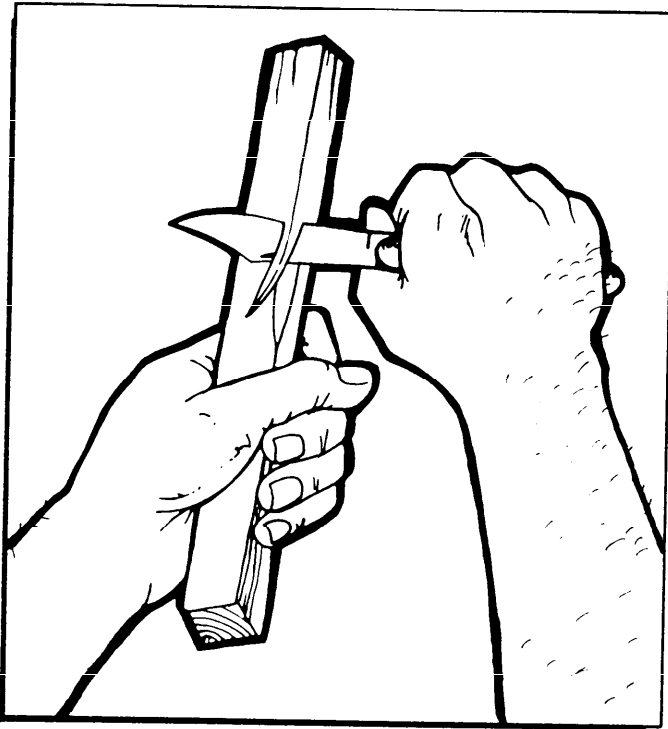

Figure 17-5. Whittling.

(3) To cut completely through a piece of wood, a series of V-cuts should be made all the way around as in figure 17-7. Once the piece of wood has been severed, the pointed end can then be trimmed.

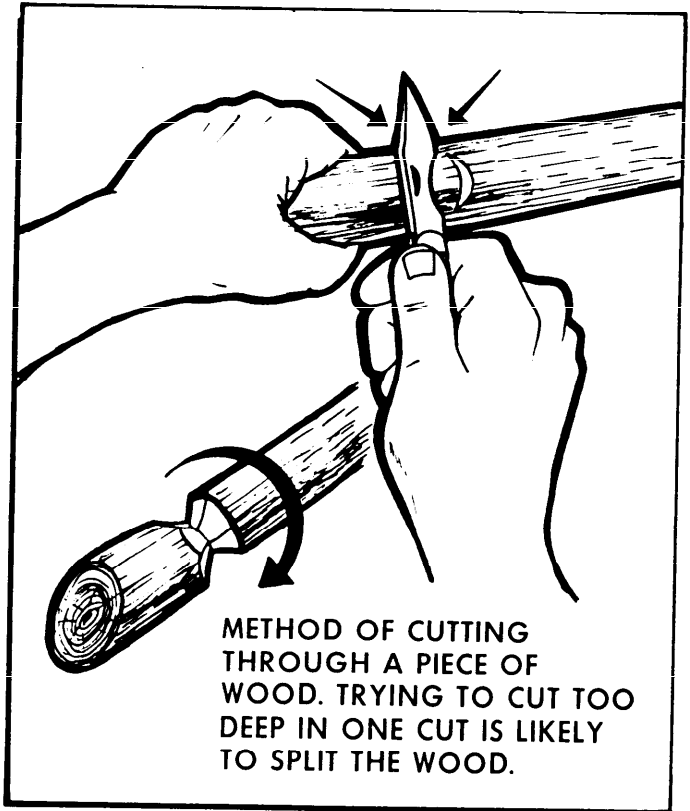

Figure 17-7. Cutting Through a Piece of Wood.

e. Felling Trees:

(1) To fell a tree, the survivor must first determine the direction in which the tree is to fall. It is best to fell the tree in the direction in which it is leaning. The lean of the tree can be found by using the axe as a plumb line

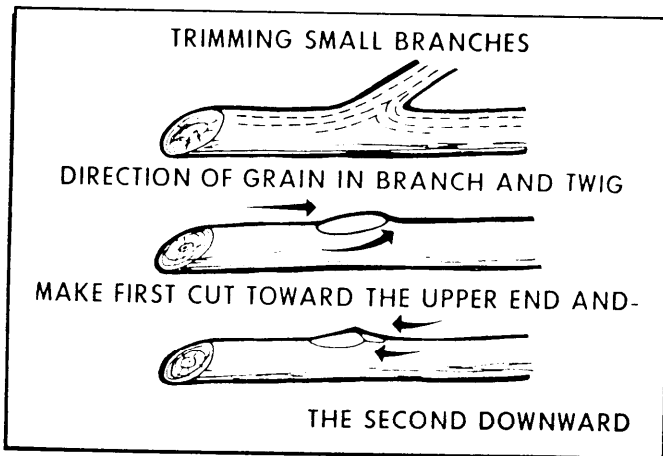

Figure 17-6. Trimming Branches.

(4) The thumb can be used to help steady the hand. Be sure and keep the thumb clear of the blade. To maintain good control of the knife, the right hand is steadied with the right thumb while the left thumb pushes the blade forward (figure 17-8). This method is very good for trimming.

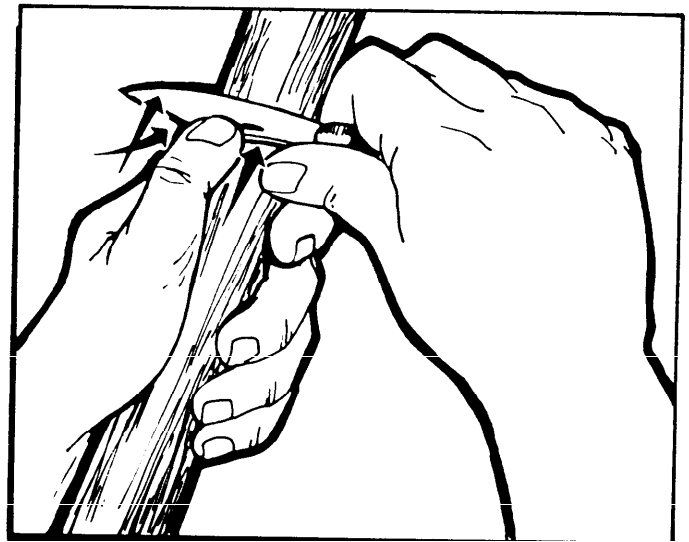

Figure 17-8. Fine Trimming.

(figure 17-9). The survivor should then clear the area around the tree from underbrush and overhanging branches to prevent injury (figure 17-10).

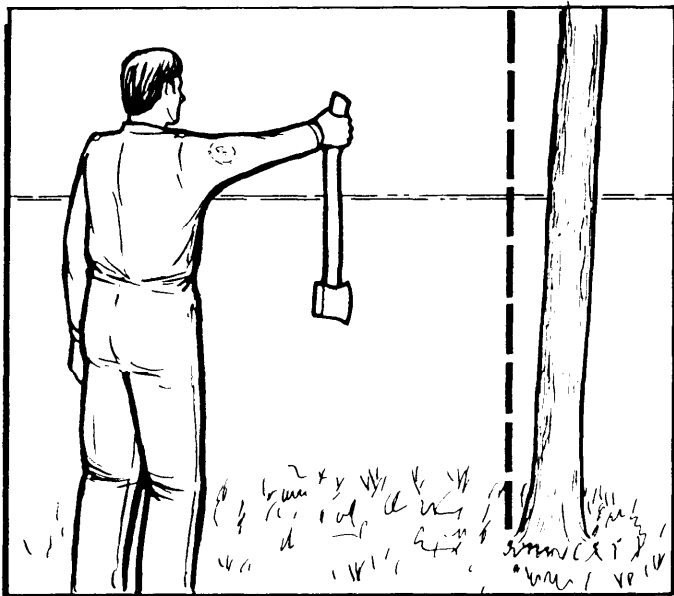

Figure 17-9. Using the Axe as a Plumb Line.

(2) The survivor should make two cuts. The first cut should be on the leaning side of the tree and close to the ground and the second cut on the opposite side and a little higher than the first cut (figure 17-11).

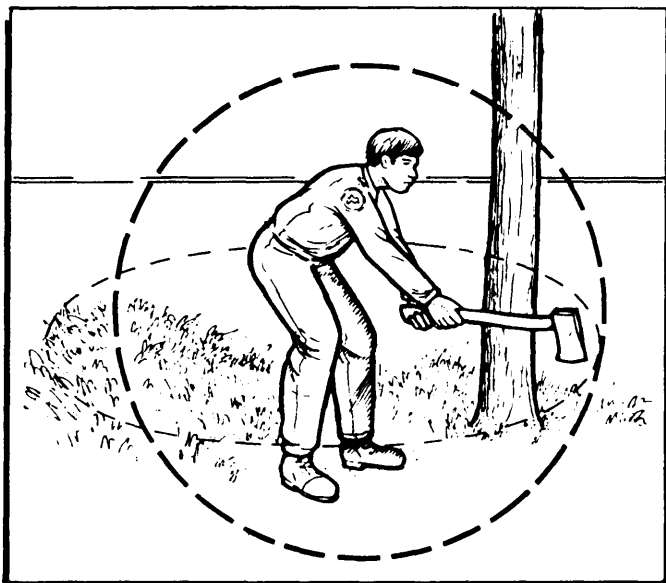

Figure 17-10. Clearing Brush from Cutting Area.

(3) Falling trees often kick back and can cause serious injury (figure 17-12), so survivors must ensure they have a clear escape route. When limbing a tree, start at

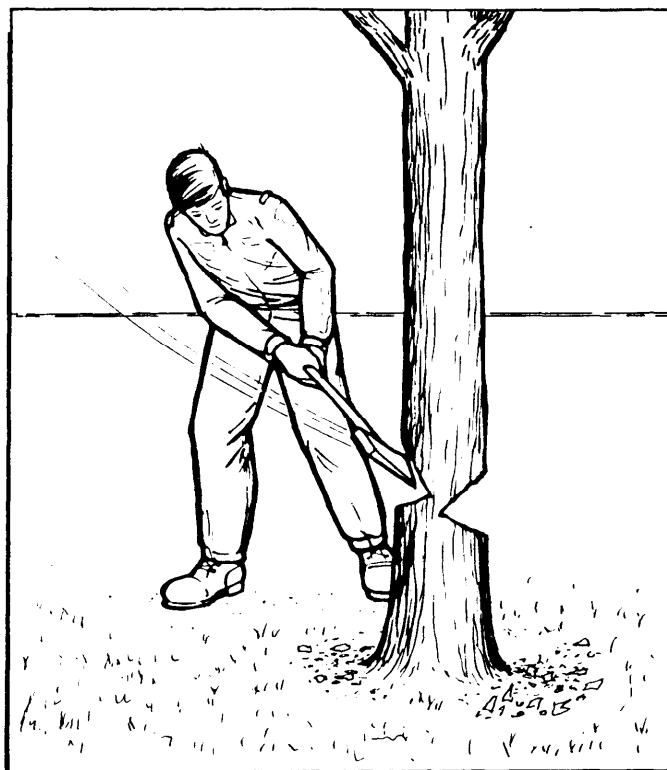

Figure 17-11. Felling Cuts.

the base of the tree and cut toward the top. This procedure will allow for easier limb removal and results in a smoother cut. For safety, the survivor should stand on one side of the trunk with the limb on the other.

(4) To prevent damage to the axe head and possible physical injury, any splitting of wood should be done on a log as in figure 17-13. The log can also be used for cutting sticks and poles (figure 17-14).

(5) To make cutting of a sapling easier, bend it over with one hand, straining grain. A slanting blow close to the ground will cut the sapling (figure 17-15).

17-4. Improvised Equipment:

a. If issued equipment is inoperative, insufficient, or nonexistent, survivors will have to rely upon their ingenuity to manufacture the needed equipment. Survivors must determine whether the need for the item outweighs the work involved to manufacture it. They will also have to evaluate their capabilities. If they have injuries, will the injuries prevent them from manufacturing the item(s)?

b. Undue haste may not only waste materials, but also waste the survivors' time and energy. Before manufacturing equipment, they should have a plan in mind.

c. The survivors' equipment needs may be met in two different ways. They may alter an existing piece of equipment to serve more than one function, or they may also construct a new piece of equipment from



Figure 17-12. Tree Kickbacks.

available materials. Since the items survivors can improvise are limited only by their ingenuity, all improvised items cannot be covered in this regulation.

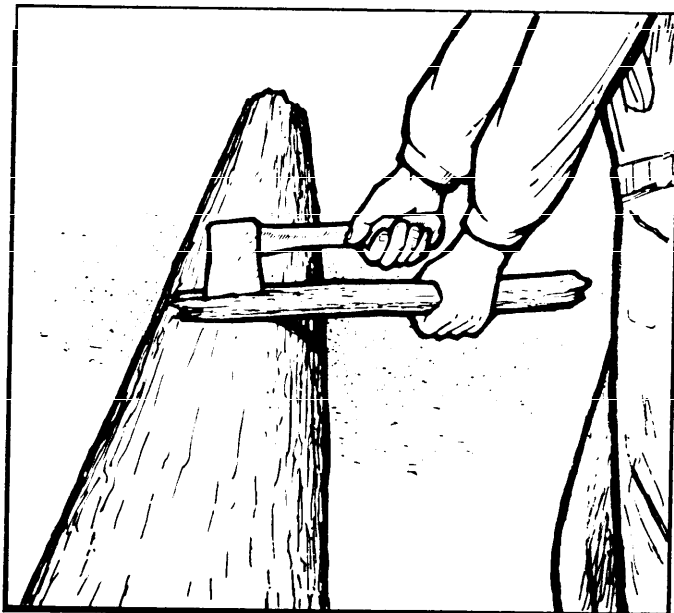

Figure 17-13. Splitting Wood.

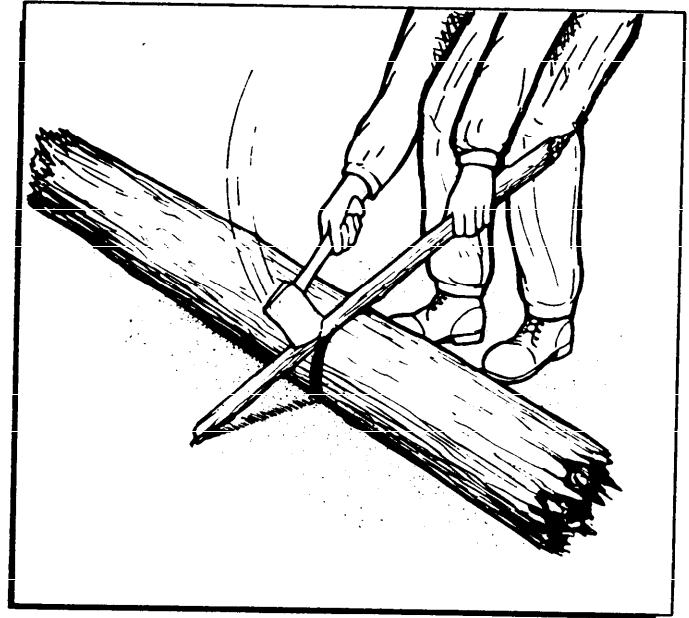

Figure 17-14. Cutting Poles.

d. The methods of manufacturing the equipment referred to in this regulation are only ideas and do not have to be strictly adhered to. Many Air Force survivors have a parachute. This device can be used to improvise a variety of needed equipment items.

e. The parachute consists of (figure 17-16):

(1) The pilot chute which deploys first and pulls the rest of the parachute out.

(2) The parachute canopy which consists of the apex (top) and the skirt or lower lateral band. The canopy material is divided by radial seams into 28 sections called gores. Each gore measures about 3 feet at the skirt and tapers to the apex. Each gore is further subdivided into four sections called panels. The canopy is normally divided into four colors. These colored areas are intended to aid the survivor in shelter construction, signaling, and camouflage.

(3) Fourteen suspension lines connect the canopy material to the harness assembly. Each piece of suspension line is 72 feet long from riser to riser and 22 feet long from riser to skirt and 14 feet from skirt to apex. The tensile strength of each piece of suspension line is 550 pounds. Each piece of suspension line contains seven to nine pieces of innercore with a tensile strength of 35 pounds. The harness assembly contains risers and webbing, buckles, snaps, "D" rings, and other hardware which can be used in improvisation.

f. The whole parachute assembly should be considered as a resource. Every piece of material and hardware can be used.

(1) To obtain the suspension lines, a survivor should cut them at the risers or, if time and conditions permit, consider disassembling the connector links. Cut



Figure 17-15. Cutting Saplings.

the suspension lines about 2 feet from the skirt of the canopy. When cutting suspension lines or dismantling the canopy/pack assembly, it will be necessary to maintain a sharp knife for safety and ease of cutting.

(2) Survivors should obtain all available suspension line due to its many uses. Even the line within the radial seams of the canopy should be stripped for possible use. The suspension line should be cut above the radial seam stitches next to the skirt end of the canopy (two places). The cut should not go all of the way through the radial seam (figure 17-17). At the apex of the canopy, and just below the radial seam stitching, a horizontal cut can be made and the suspension line extracted. The line can then be cut.

(3) For maximum use of the canopy, survivors must plan its disassembly. The quantity requirements for shelter, signaling, etc., should be thought out and planned for. Once these needs have been determined, the canopy may be cut up. The radial seam must be stretched tightly for ease of cutting. The radial seam can then be cut by holding the knife at an angle and following the center of the seam. With proper tension and the gentle pushing (or pulling) of a sharp blade there will be

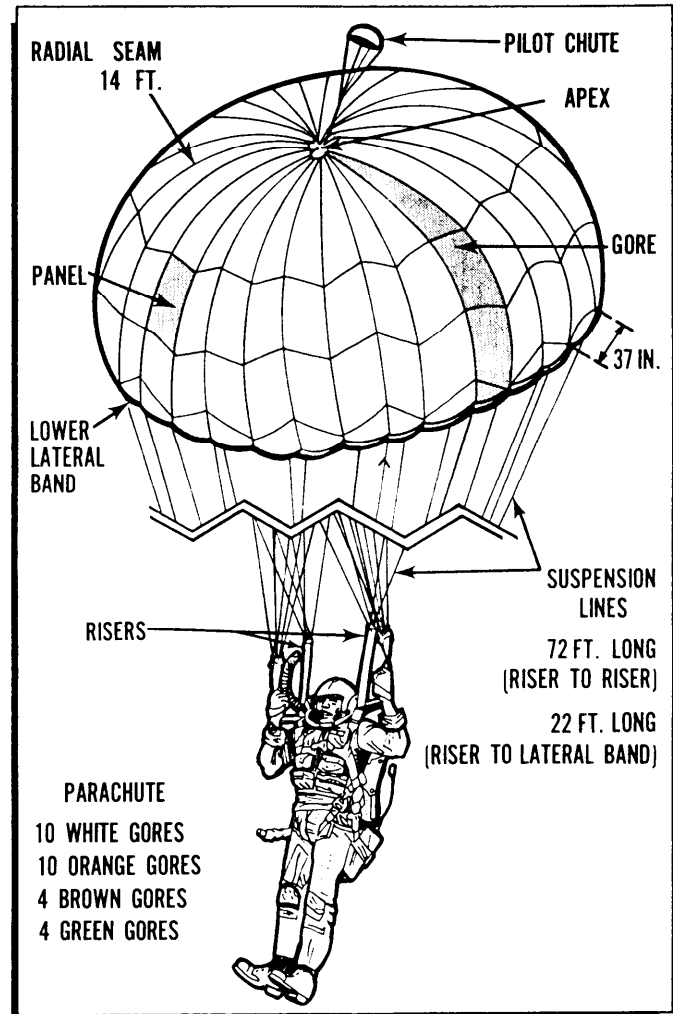

Figure 17-16. Parachute Diagram.

a controlled splitting of the canopy at the seam (figure 17-17). It helps to secure the apex either to another individual or to an immobile object such as a tree.

(4) When stripping the harness assembly, the seams of the webbing should be split so the maximum usable webbing is obtained. The harness material and webbing should not be randomly cut as it will waste much needed materials.

g. One requirement in improvising is having available material. Parachute fabric, harness, suspension lines, etc., can be used for clothing. Needles are helpful for making any type of emergency clothing. Wise survivors should always have extra sewing needles hidden somewhere on their person. A good needle or sewing awl can be made from the can-opening key from the ration tin (figure 17-18) or, as the Eskimos do, from a sliver of bone. Thread is usually available in the form of innercore. It will be to the survivor's benefit to collect small objects which may "come in handy." Wire, nails, buttons, a piece of canvas, or animal skin should not be

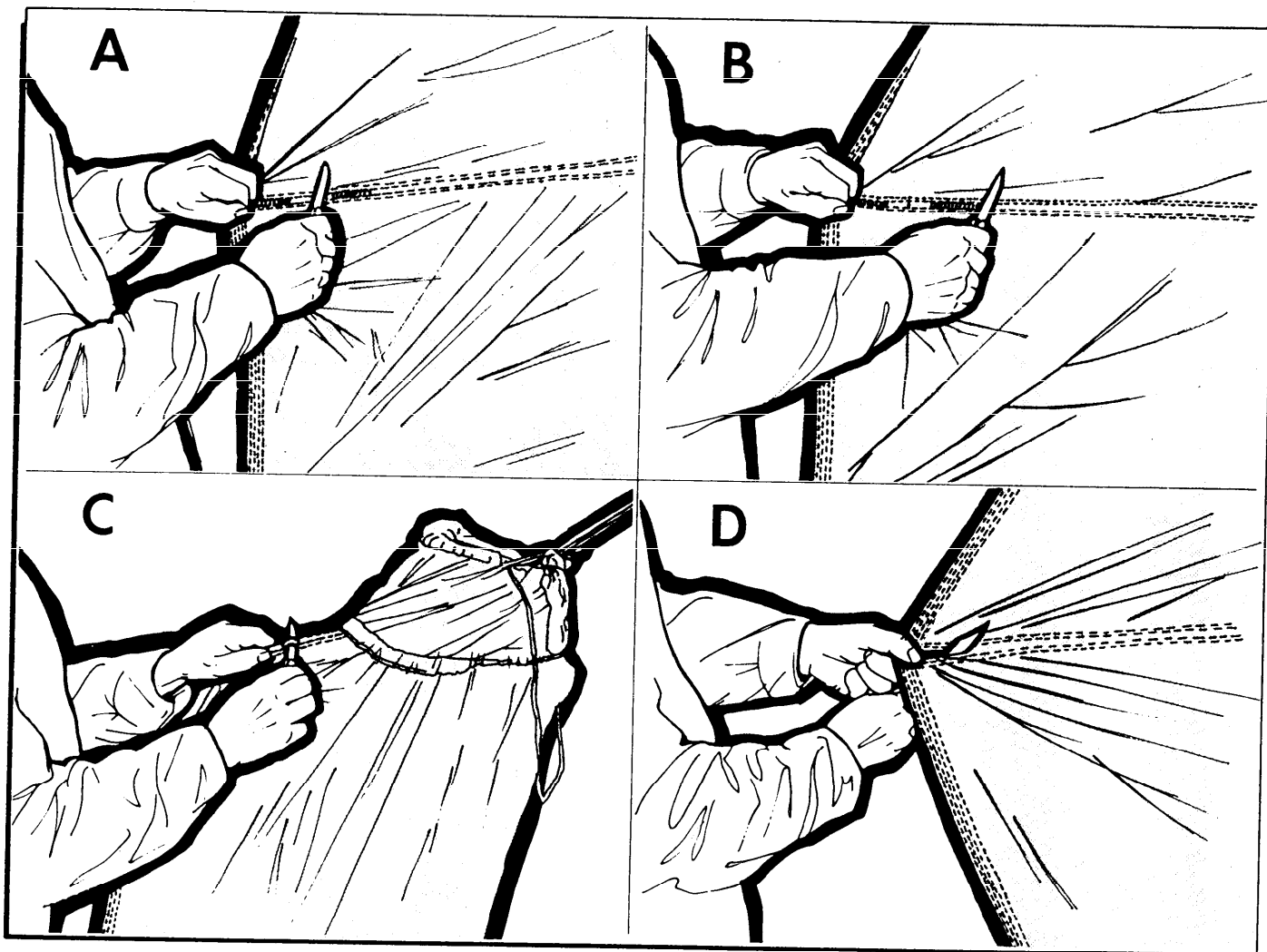

Figure 17-17. Cutting the Parachute.

discarded. Any such object may be worth its weight in gold when placed in a hip pocket or a sewing kit. Any kind of animal skin can be used for making clothing such as gloves or mittens or making a ground cover to keep the sleeping bag dry and clean. Small skins can be used for mending and for boot insoles. Mending and cleaning clothes when possible will pay dividends in health, comfort, and safety.

h. The improvised equipment survivors may need to make will probably involve sewing. The material to be sewn may be quite thick and hard to sew, and to keep from stabbing fingers and hands, a palm-type thimble can be improvised (figure 17-19). A piece of webbing, leather, or other heavy material, with a hole for the thumb, is used. A flat rock, metal, or wood is used as the thimble and this is held in place by a doughnut-shaped piece of material sewn onto the palm piece. To use, the end of the needle with the eye is placed on the thimble and the thimble is then used to push the needle through the material to be sewn.

17-5. Miscellaneous Improvised Equipment:

a. Improvised Trail-Type Snowshoes. The snowshoe frame can be made from a sapling 1 inch in diameter and 5 feet long. The sapling should be bent and spread to 12 inches at the widest point. The survivor can then include the webbing of suspension lines (figure 17-20). The foot harness, for attaching the snowshoe to the boot, is also fashioned from suspension line.

b. Improvised Bear Paw-Type Snowshoes. A sapling can be held over a heat source and bent to the shape shown in figure 17-21. Wire from the aircraft or parachute suspension line can be used for lashing and for making webbing. Snowshoes can also be quickly improvised by cutting a few pine boughs and lashing them together at the cut ends. The lashed boughs positioned with the cut ends forward can then be tied to the feet (figure 17-22).

(1) Survivors should guard against frostbite and blistering while snowshoeing. Due to the design of the

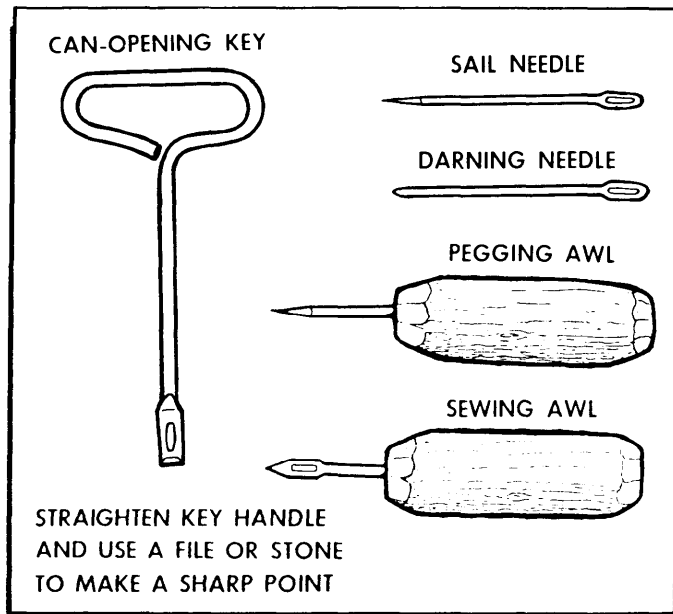

Figure 17-18. Needle and Sewing Awl.

harness, the circulation of the toes is usually restricted, and the hazard of frostbite is greater. They should check the feet carefully, stop often, take off the harness, and massage the feet when they seem to be getting cold.

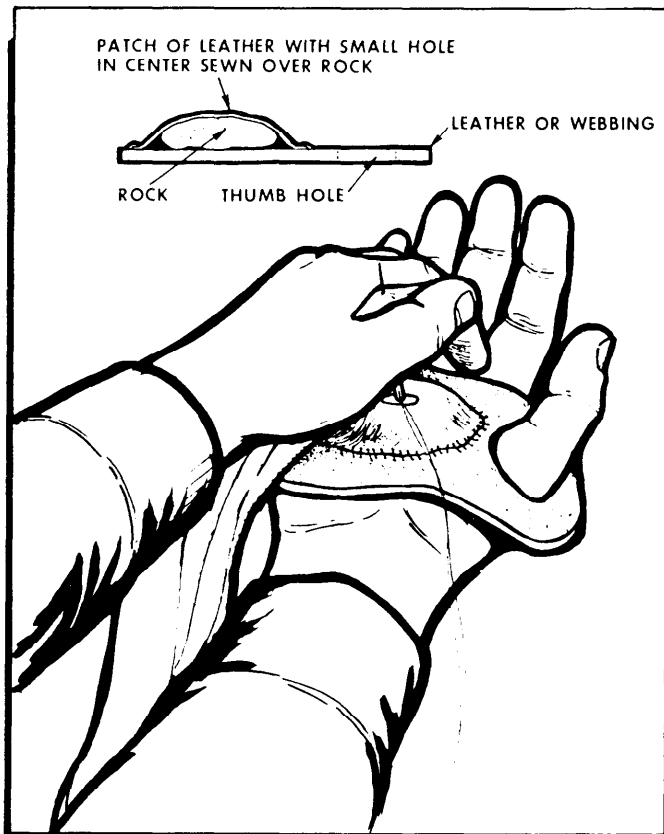

Figure 17-19. Palm Thimble.

(2) Blistering between the toes or on the ball of the foot is sometimes unavoidable in a "tenderfoot" if much snowshoeing is done. To make blisters less likely, the survivor should keep socks and insoles dry and change them regularly.

c. Sleeping Bag. Immediate action should be to use the whole parachute until conditions allow for improvising. A sleeping bag can be improvised by using four gores of parachute material or an equivalent amount of other materials (figure 17-23). The material should be folded in half lengthwise and sewn at the foot. To measure the length, the survivor should allow an extra 6 to 10 inches in addition to the individual's height. The two raw edges can then be sewn together. The two sections of the bag can be filled with cattail down, goat's beard lichen, dry grass, insulation from aircraft walls, etc. The

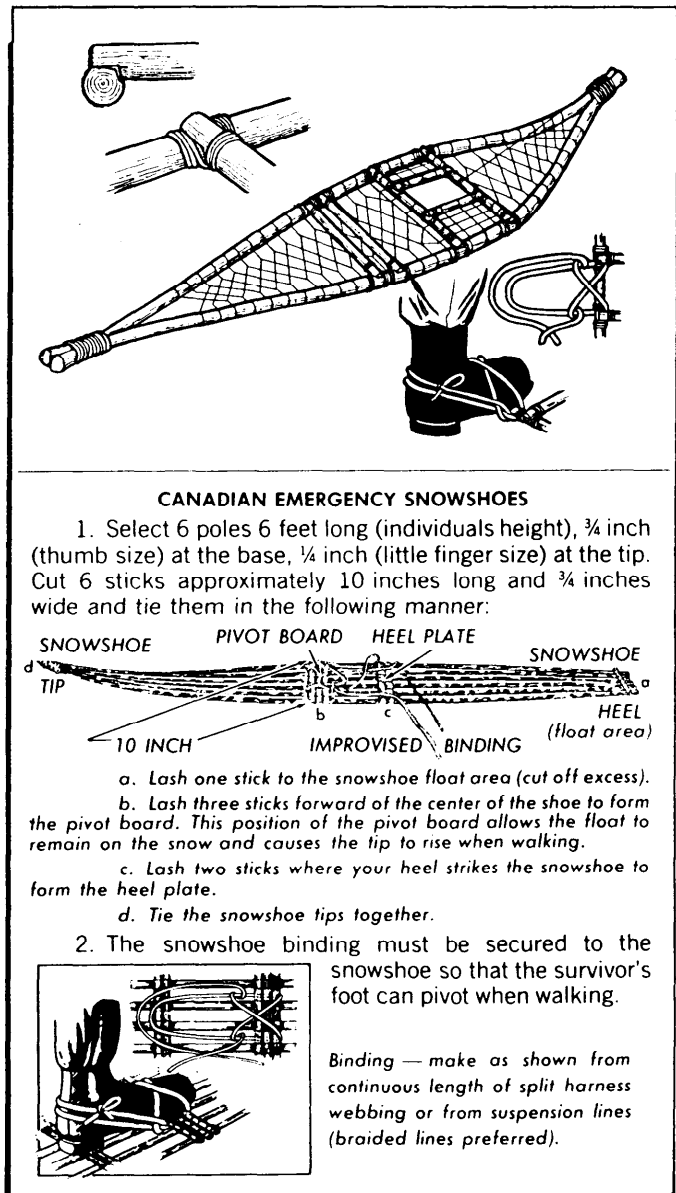

Figure 17-20. Improved Trail Snowshoes.

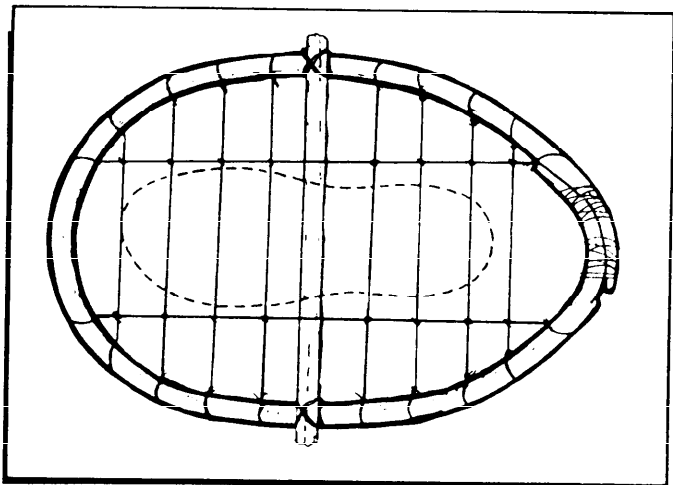

Figure 17-21. Improved Bear Paws.

stuffed sleeping bag should then be quilted to keep the insulation from shifting. The bag can be folded in half lengthwise and the foot and open edges sewn. The length and width can be adjusted for the individual.

d. Insulating Bed:

(1) In addition to the sleeping bag, some form of ground insulation is advisable. An insulation mat will help insulate the survivor from ground moisture and the cold. Any nonpoisonous plants such as ferns and grasses will suffice. Leaves from a deciduous tree make a comfortable bed. If available, extra clothing, seat cushions, aircraft insulation, rafts, and parachute material may be used. In a coniferous forest, boughs from the trees would do well if the bed is constructed properly.

(2) The survivor should start at the foot of the proposed bed and stick the cut ends in the ground at about a 45-degree angle and very close together. The completed bed should be slightly wider and longer than the body. If the ground is frozen, a layer of dead branches can be used on the ground with the green boughs placed in the dead branches, similar to sticking them in the ground.

(3) A bough bed should be a minimum of 12 inches thick before use. This will allow sufficient insulation between the survivor and the ground once the bed is compressed. The bough bed should be fluffed up and boughs added daily to maintain its comfort and insulation capabilities.

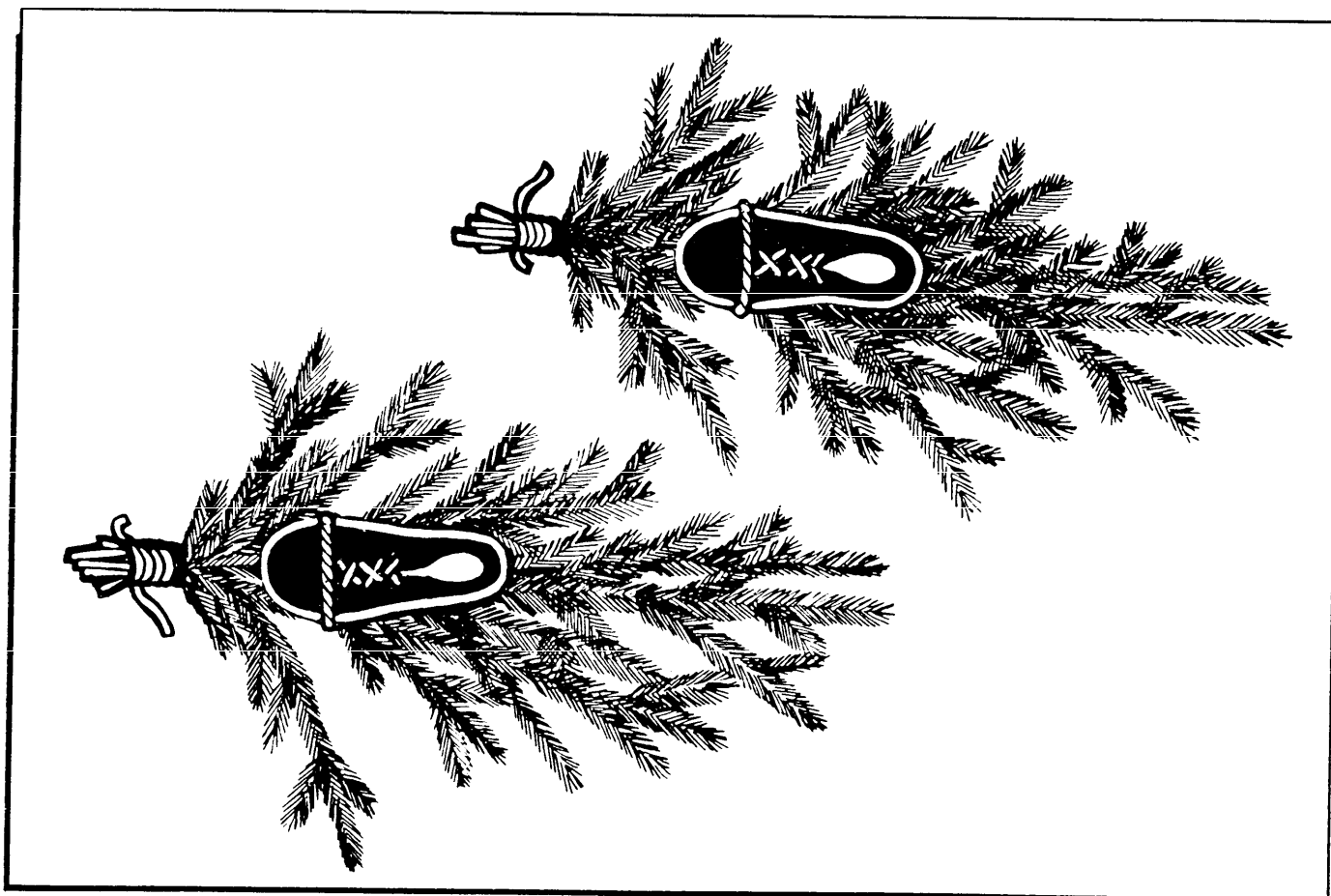

Figure 17-22. Bough Snowshoes.

(4) Spruce boughs have many sharp needles and can cause some discomfort. Also the needles on various types of pines are generally located on the ends of the boughs, and it would take an abundance of pine boughs to provide comfort and insulation. Fir boughs on the other hand, have an abundance of needles all along the boughs and the needles are rounded. These boughs are excellent for beds, providing comfort and insulation (figure 17-24).

e. Rawhide. Rawhide is a very useful material which can be made from any animal hide. Processing it is time consuming but the material obtained is strong and very durable. It can be used for making sheaths for cutting tools, lashing materials, ropes, etc.

(1) The first step in making rawhide is to remove all of the fat and muscle tissue from the hide. The large pieces can be cut off and the remainder scraped off with a dull knife or similar instrument.

(2) The next step is to remove the hair. This can be done by applying a thick layer of wood ashes to the hair side. Ashes from a hardwood fire work best. Thoroughly sprinkle water all over the ashes. This causes lye to leach out of the ash. The lye will remove the hair. The hide should be rolled with the hair side in and stored in a cool place for several days. When the hair begins to slip (check by pulling on the hair), the hide should be unrolled and placed over a log. Remove the hair by scraping it off with a dull knife. Once the hair is removed, the

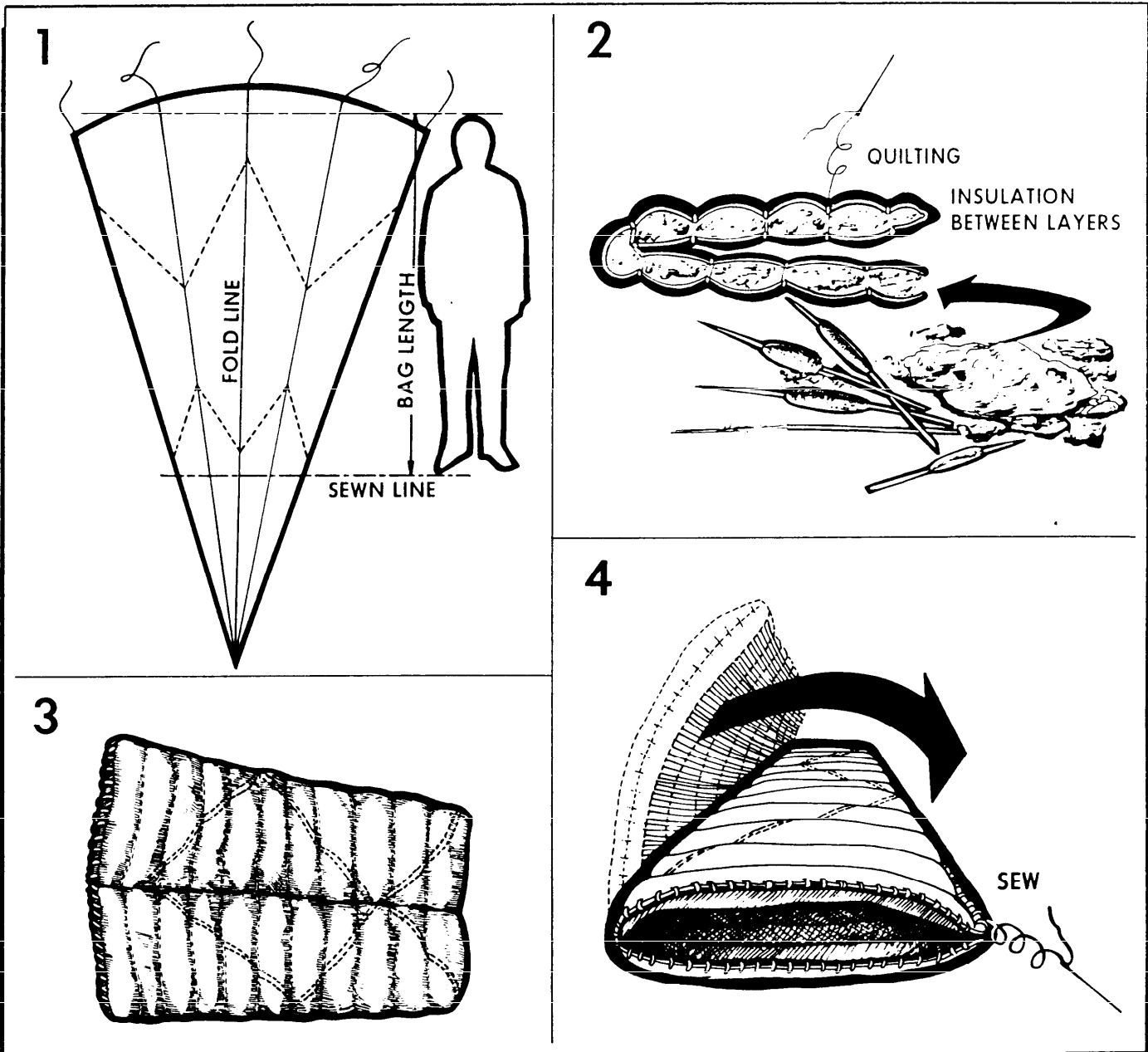

Figure 17-23. Improved Sleeping Bag.

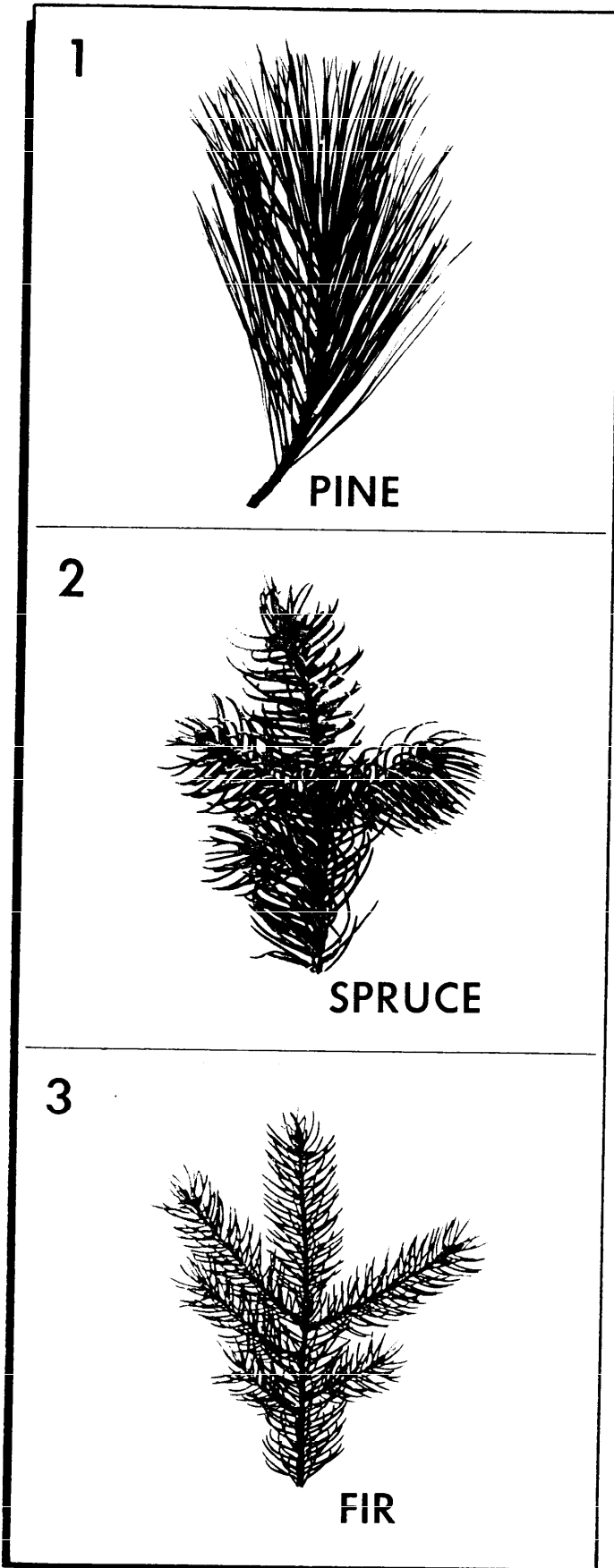

Figure 17-24. Boughs.

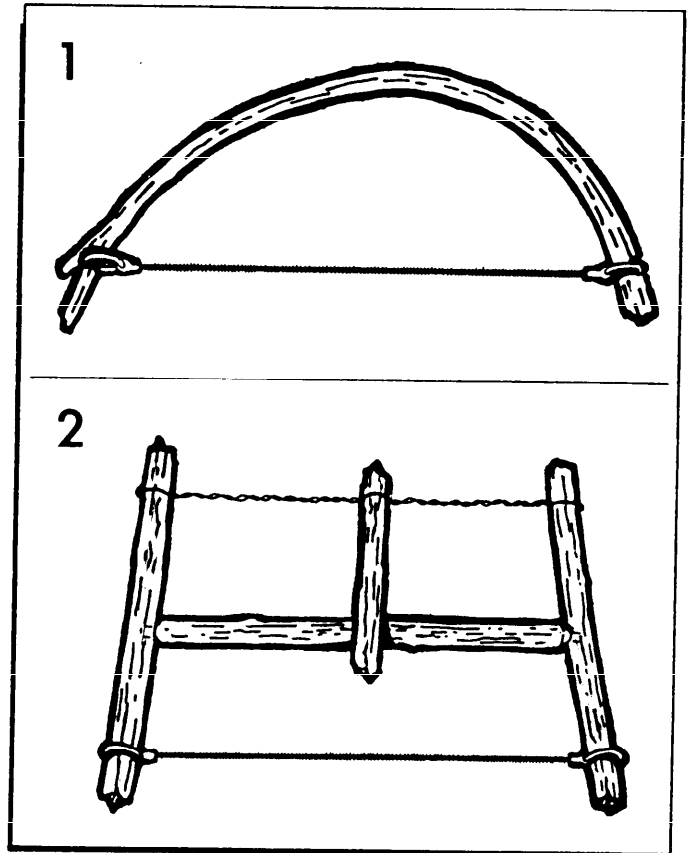

Figure 17-25. Bow Saw and Buck Saw.

hide should be thoroughly washed, stretched inside a frame, and allowed to dry slowly in the shade. When dry, rawhide is extremely hard. It can be softened by soaking in water.

f. **Wire Saws.** Wire or pieces of metal can be used to replace broken issued saws. With minor modifications, the survivor can construct a usable saw. A bow-saw

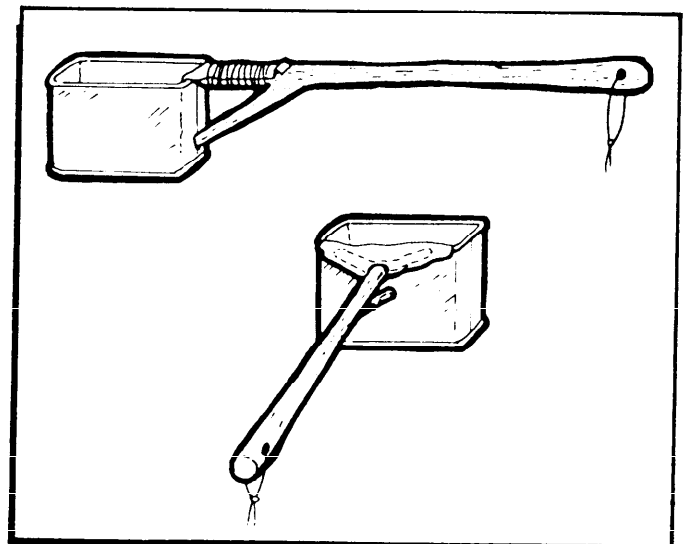

Figure 17-26. Cooking Utensils.

arrangement will help to prevent the blade from flexing. A green sapling may be used for the bow as shown in figure 17-25. If a more durable saw is required and time permits, a bucksaw may be improvised (figure 17-25). Blade tension can be maintained by use of a tightening device known as a "windlass" (figure 17-25).

g. Cooking Utensils. Ration tins can serve as adequate cooking utensils. If the end has been left intact as in figure 17-26, use a green stick long enough to prevent burning the hand while cooking. If the side has been left intact, a forked stick may be used to add support to the container (figure 17-26).

17-6. Ropes and Knots:

a. Basic Knowledge of Tying a Knot. A basic knowledge of correct rope and knot procedures will aid the survivor to do many necessary actions. Such actions as improvising equipment, building shelters, assembling packs, and providing safety devices require the use of proven techniques. Tying a knot incorrectly could result in ineffective improvised equipment, injury, or death.

b. Rope Terminology: (See figure 17-27.)

(1) Bend. A bend (called a knot in this regulation) is used to fasten two ropes together or to fasten a rope to a ring or loop.

(2) Bight. A bight is a bend or U-shaped curve in a rope.

(3) Hitch. A hitch is used to tie a rope around a timber, pipe, or post so that it will hold temporarily but can be readily untied.

(4) Knot. A knot is an interlacement of the parts of bodies, as cordage, forming a lump or knot or any tie or fastening formed with a cord, rope, or line, including bends, hitches, and splices. It is often used as a stopper to prevent a rope from passing through an opening.

(5) Line. A line (sometimes called a rope) is a single thread, string, or cord.

(6) Loop. A loop is a fold or doubling of the rope through which another rope can be passed. A temporary loop is made by a knot or a hitch. A permanent loop is made by a splice or some other permanent means.

(7) Overhand Turn or Loop. An overhand loop is made when the running end passes over the standing part.

(8) Rope. A rope (often called a line) is made of strands of fiber twisted or braided together.

(9) Round Turn. A round turn is the same as a turn, with running end leaving the circle in the same general direction as the standing part.

(10) Running End. The running end is the free or working end of a rope.

(11) Standing End. The standing end is the balance of the rope, excluding the running end.

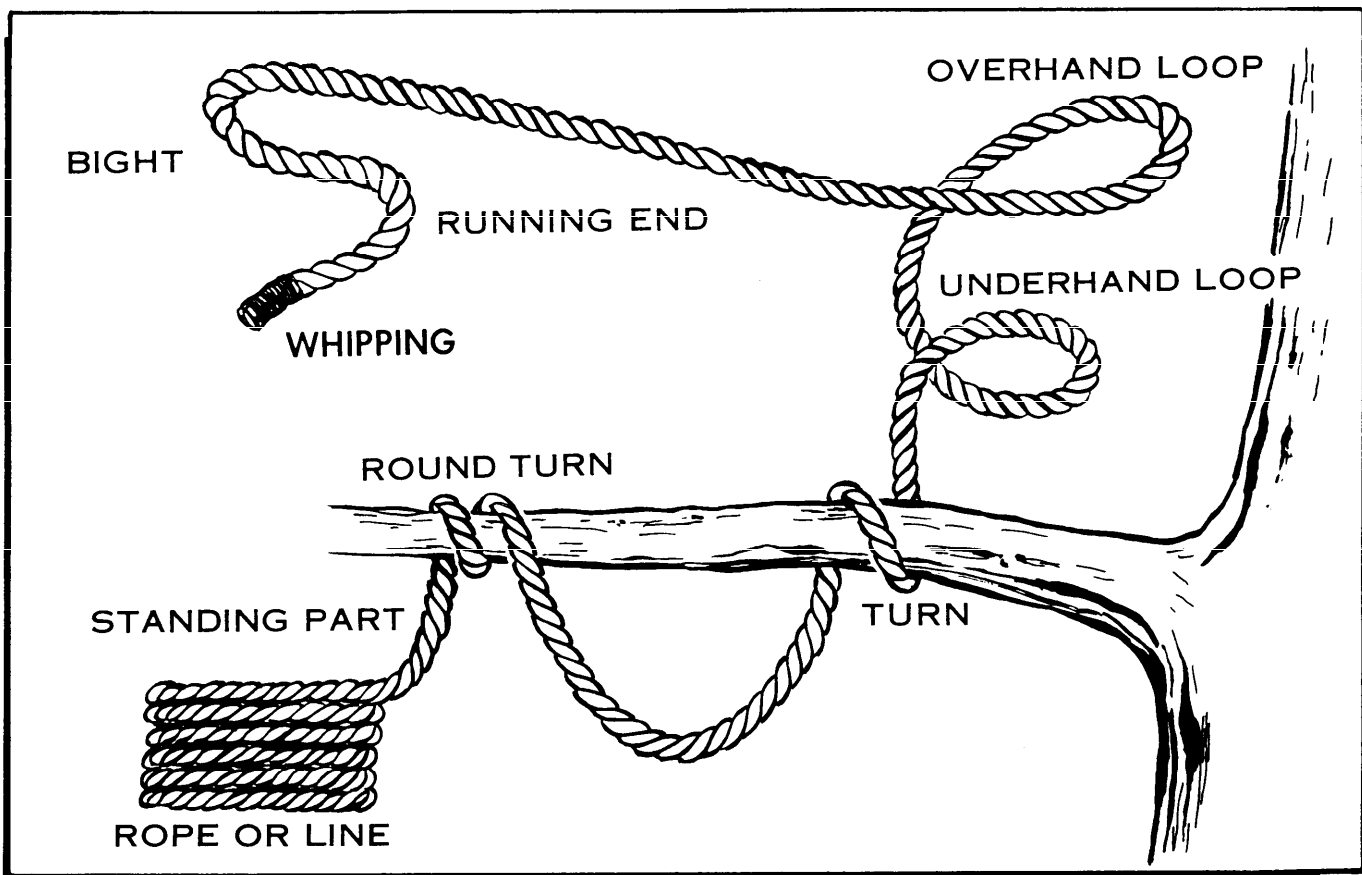

Figure 17-27. Elements of Ropes and Knots.

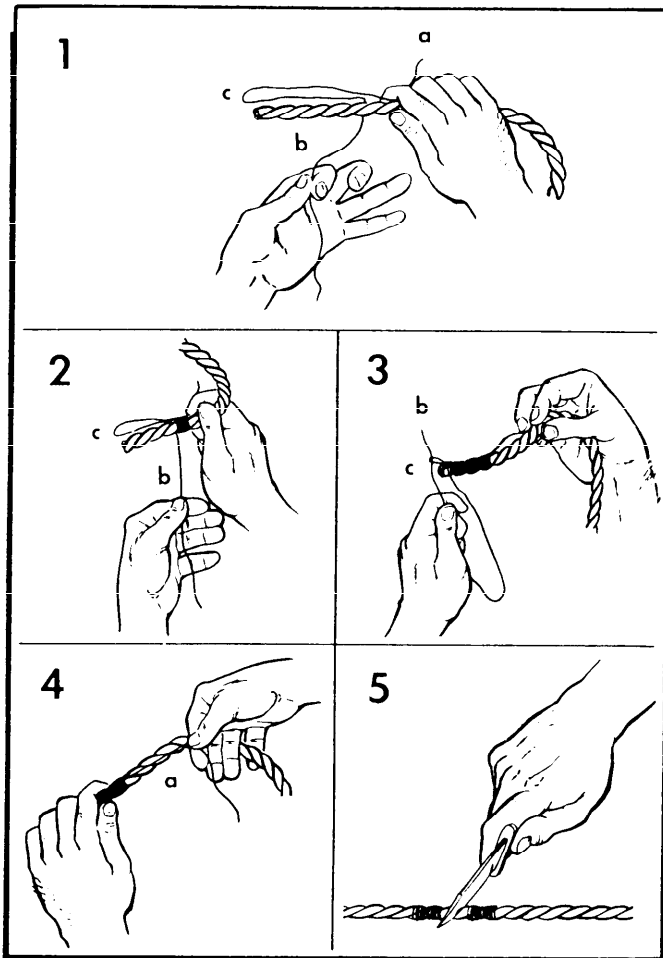

Figure 17-28. Whipping the End of a Rope.

(12) Turn. A turn describes the placing of a rope around a specific object such as a post, rail, or ring with the running end continuing in the opposite direction from the standing end.

(13) Underhand Turn or Loop. An underhand turn or loop is made when the running end passes under the standing part.

c. Whipping the Ends of a Rope. The raw, cut end of a rope has a tendency to untwist and should always be knotted or fastened in some manner. Whipping is one method of fastening the end of the rope. This method is particularly satisfactory because it does not increase the size of the rope. The whipped end of a rope will still

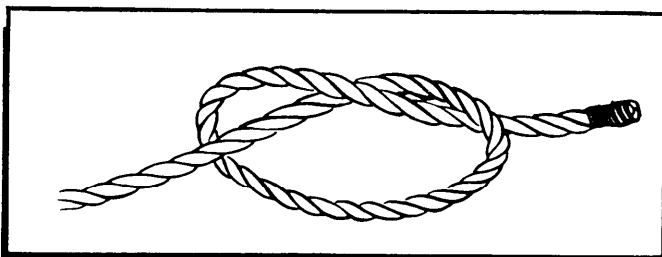

Figure 17-29. Overhand Knot.

thread through blocks or other openings. Before cutting a rope, place two whippings on the rope 1 or 2 inches apart and make the cut between the whippings (figure 17-28-5). This will prevent the cut ends from untwisting immediately after they are cut. A rope is whipped by wrapping the end tightly with a small cord. Make a bight near one end of the cord and lay both ends of the small cord along one side of the rope (figure 17-28-1). The bight should project beyond the end of the rope about one-half inch. The running end (b) of the cord should be wrapped tightly around the rope and cord (figure 17-28-2) starting at the end of the whipping which will be farthest from the end of the rope. The wrap should be in the same direction as the twist of the rope strands. Continue wrapping the cord around the rope, keeping it tight, to within about one-half inch of the end. At this point, slip the running end (b) through the bight of the cord (figure 17-28-3). The standing part of the cord (a) can then be pulled until the bight of the cord is pulled under the whipping and cord (b) is tightened (figure 17-28-4). The ends of cord (a and b) should be cut at the edge of the whipping, leaving the rope end whipped.

d. Knots at End of the Rope:

(1) Overhand Knot. The overhand knot (figure 17-29) is the most commonly used and the simplest of all knots. An overhand knot may be used to prevent the end of a rope from untwisting, to form a knot at the end of a rope, or as a part of another knot. To tie an overhand knot, make a loop near the end of the rope and pass the running end through the loop, pulling it tight.

(2) Figure-Eight Knot. The figure-eight knot (figure 17-30) is used to form a larger knot than would be formed by an overhand knot at the end of a rope. A figure-eight knot is used in the end of a rope to prevent the ends from slipping through a fastening or loop in another rope. To make the figure-eight knot, make a loop in the standing part, pass the running end around

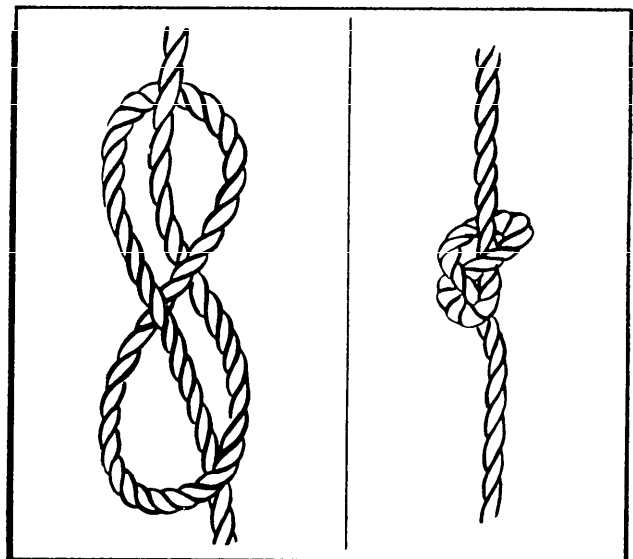

Figure 17-30. Figure-Eight Knot.

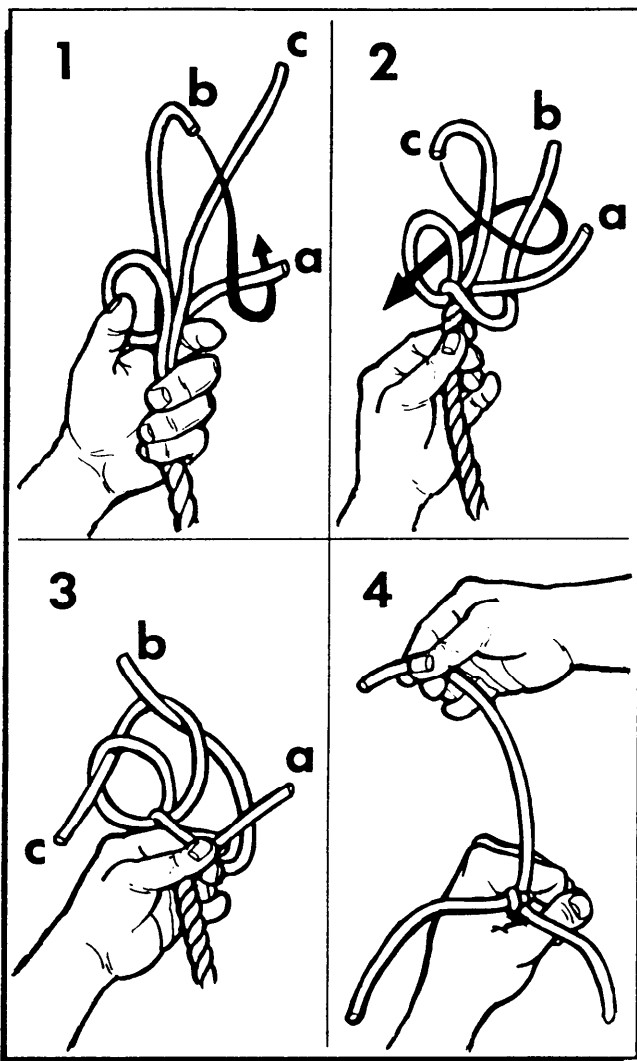

Figure 17-31. Wall Knot.

the standing part back over one side of the loop, and down through the loop. The running end can then be pulled tight.

(3) Wall Knot. The wall knot (figure 17-31) with a crown is used to prevent the end of a rope from untwisting when an enlargement is not objectionable. It also makes a desirable knot to prevent the end of the rope from slipping through small openings, as when rope handles are used on boxes. The crown or the wall knots may be used separately. To make the wall knot, untwist the strands for about five turns of the rope. A loop in strand "a" (figure 17-32-1) should be used and strand "b" brought down (figure 17-31-2) and around strand "a." Strand "c" (figure 17-31-3) can then be brought around strand "b" and through the loop in strand "a." The knot can then be tightened (figure 17-31-4) by grasping the rope in one hand and pulling each strand tight. The strands point up or away from the rope. To make a neat, round knot, the wall knot should be crowned.

(4) Crown on Wall Knot. To crown a wall knot, the end of strand "a" (figure 17-32-1) should be moved between strands "b" and "c." Next strand "c" is passed (figure 17-32-2) between strand "b" and the loop in strand "a." Line "b" is then passed over line "a" and through the bight formed by line "c" (figure 17-32-3). The knots can then be drawn tight and the loose strands cut. When the crown is finished, strands should point down or back along the rope.

e. Knots for Joining Two Ropes:

(1) Square Knot. The square knot (figure 17-33) is used for tying two ropes of equal diameter together to prevent slippage. To tie the square knot, lay the running end of each rope together but pointing in opposite directions. The running end of one rope can be passed under

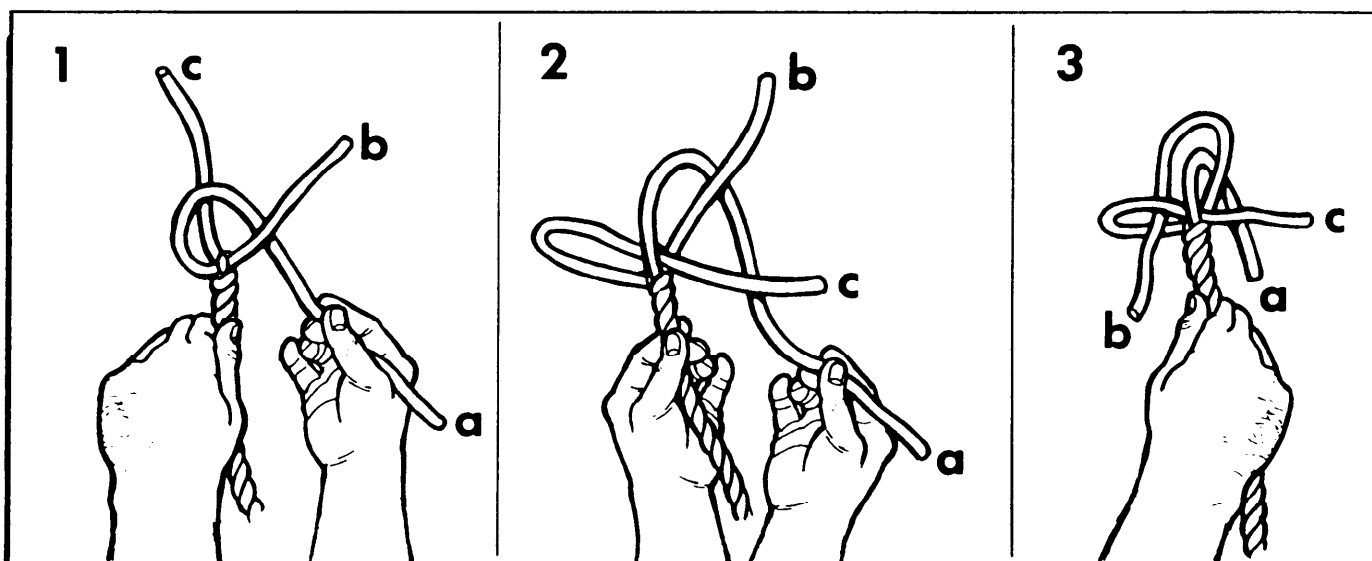

Figure 17-32. Crown on Wall Knot.

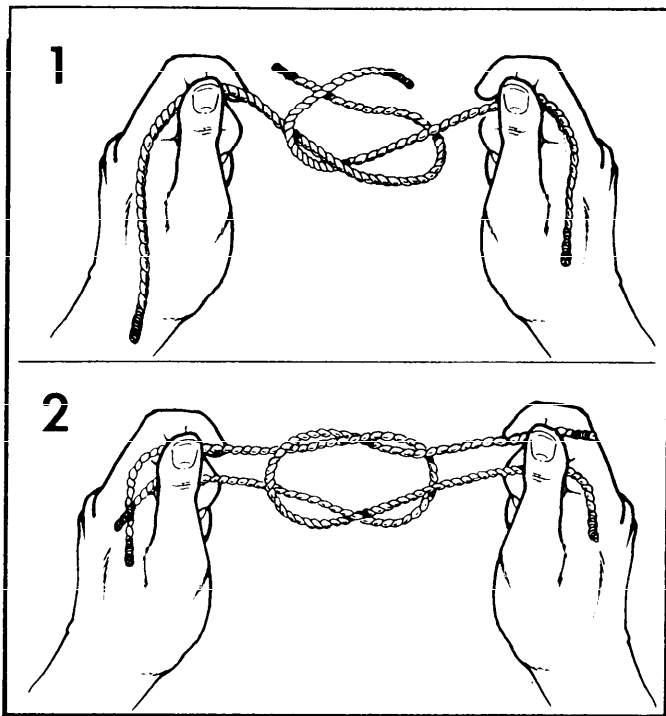

Figure 17-33. Square Knot.

the standing part of the other rope. Bring the two running ends up away from the point where they cross and crossed again (figure 17-33-1). Once each running end is parallel to its own standing part (figure 17-33-2), the two ends can be pulled tight. If each running end does not come parallel to the standing part of its own rope, the knot is called a "granny knot" (figure 17-34-1). Because it will slip under strain, the granny knot should not be used. A square knot can also be tied by making a bight in the end of one rope and feeding the running end of the other rope through and around this bight. The

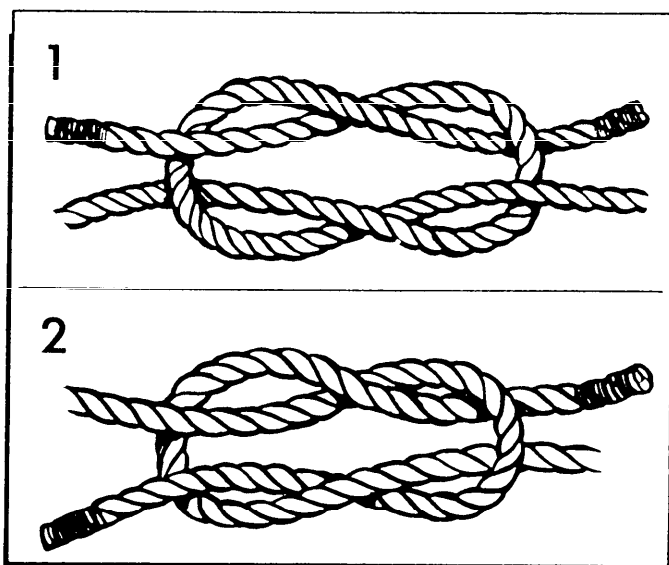

Figure 17-34. Granny and Thief Knots.

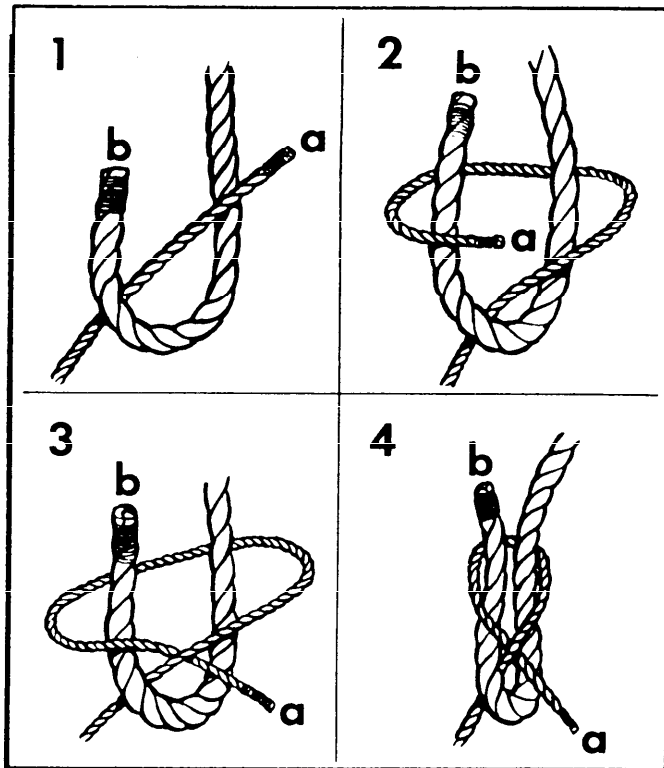

Figure 17-35. Single Sheet Bend.

running end of the second rope is routed from the standing side of the bight. If the procedure is reversed, the resulting knot will have a running end parallel to each standing part but the two running ends will not be opposite each other. This knot is called a "thief" knot (figure 17-34-2). It will slip under strain and is difficult to untie. A true square knot will draw tighter under

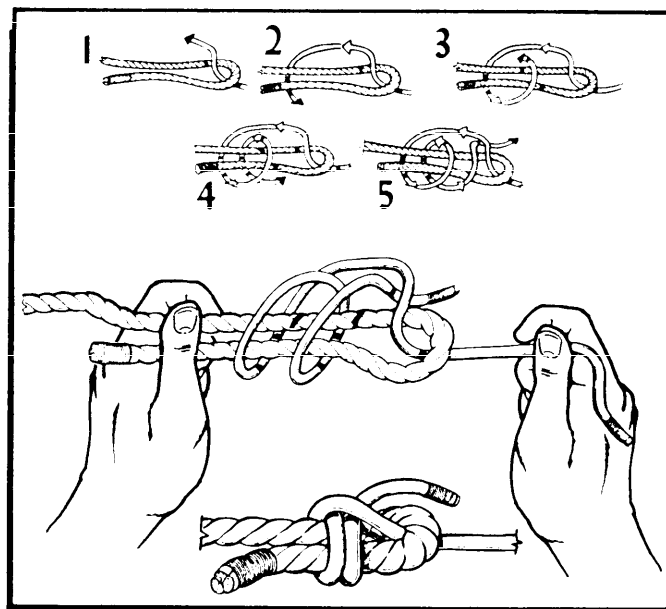

Figure 17-36. Double Sheet Bend.

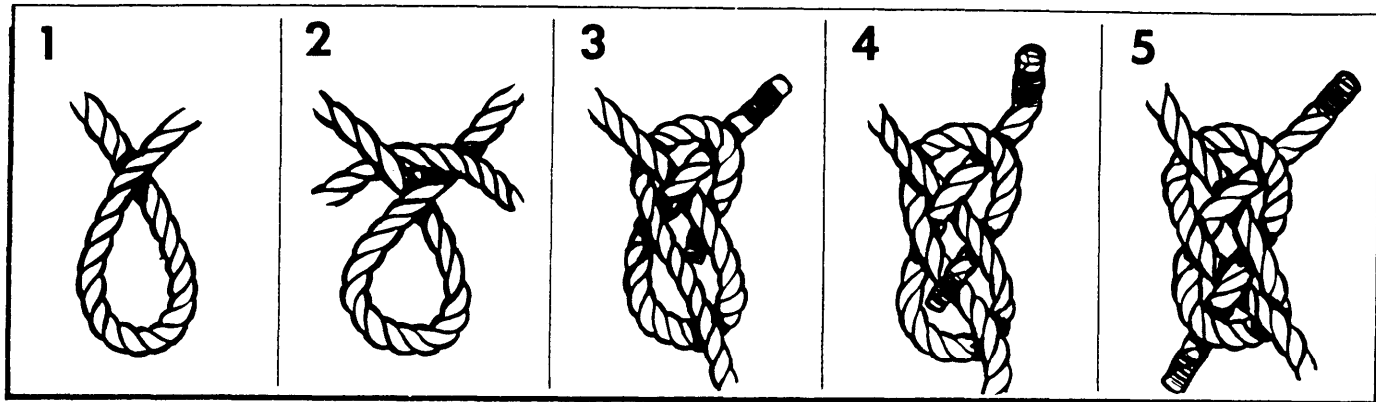

Figure 17-37. Carrick Bend.

strain. A square knot can be untied easily by grasping the bends of the two bights and pulling the knot apart.

(2) Single Sheet Bend. The use of a single sheet bend (figure 17-35), sometimes called a weaver's knot, is limited to tying together two dry ropes of unequal size. To tie the single sheet bend, the running end (a) (figure 17-35-1) of the smaller rope should pass through a bight (b) in the larger rope. The running end should continue around both parts of the larger rope (figure 17-35-2), and back under the smaller rope (figure 17-35-3). The running end can then be pulled tight (figure 17-35-4). This knot will draw tight under light loads but may loosen or slip when the tension is released.

(3) Double Sheet Bend. The double sheet bend (figure 17-36) works better than the single sheet bend for joining ropes of equal or unequal diameter, joining wet ropes, or for tying a rope to an eye. It will not slip or draw tight under heavy loads. To tie a double sheet bend, a single sheet bend is tied first. However, the running end is not pulled tight. One extra turn is taken around both sides of the bight in the larger rope with the running end for the smaller rope. Then tighten the knot.

(4) Carrick Bend. The carrick bend (figure 17-37) is used for heavy loads and for joining thin cable or heavy

rope. It will not draw tight under a heavy load. To tie a carrick bend, a loop is formed (figure 17-37-1) in one rope. The running end of the other rope is passed behind the standing part (figure 17-37-2) and in front of the running part of the rope in which the loop has been formed. The running end should then be woven under one side of the loop (figure 17-37-3), through the loop, over the standing part of its own rope (figure 17-37-4), down through the loop, and under the remaining side of the loop (figure 17-37-5).

f. Knots for Making Loops:

(1) Bowline. The bowline (figure 17-38) is a useful knot for forming a loop in the end of a rope. It is also easy to untie. To tie the bowline, the running end (a) of the rope passes through the object to be affixed to the bowline and forms a loop (b) (figure 17-38-1) in the standing part of the rope. The running end (a) is then passed through the loop (figure 17-38-2) from underneath and around the standing part (figure 17-38-3) of the rope, and back through the loop from the top (figure 17-38-4). The running end passes down through the loop parallel to the rope coming up through the loop. The knot is then pulled tight.

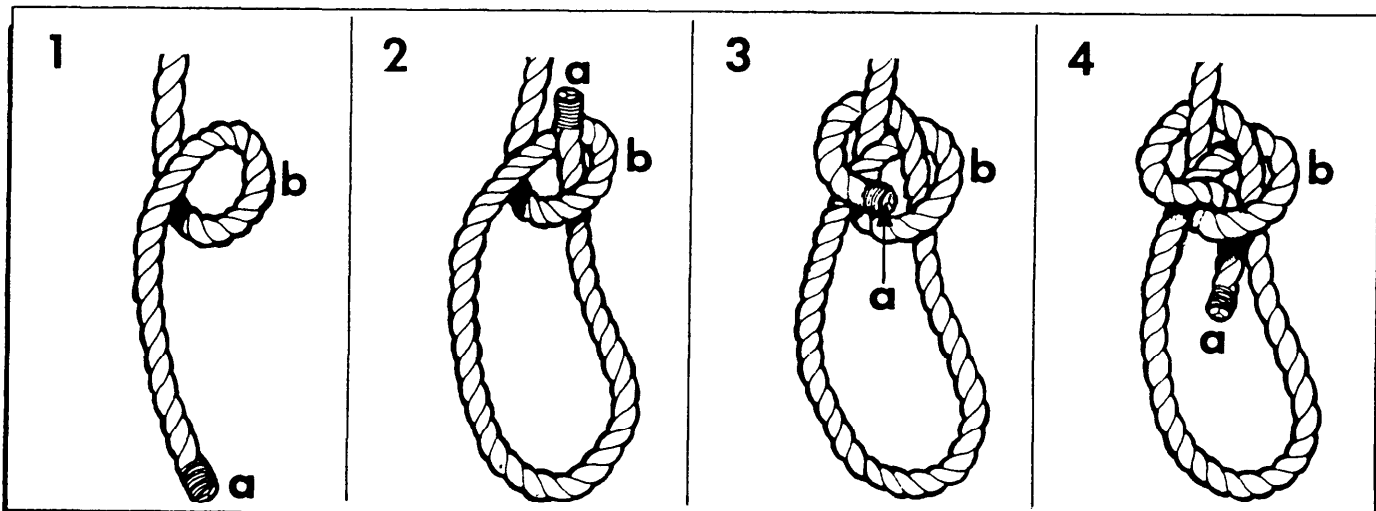

Figure 17-38. Bowline.

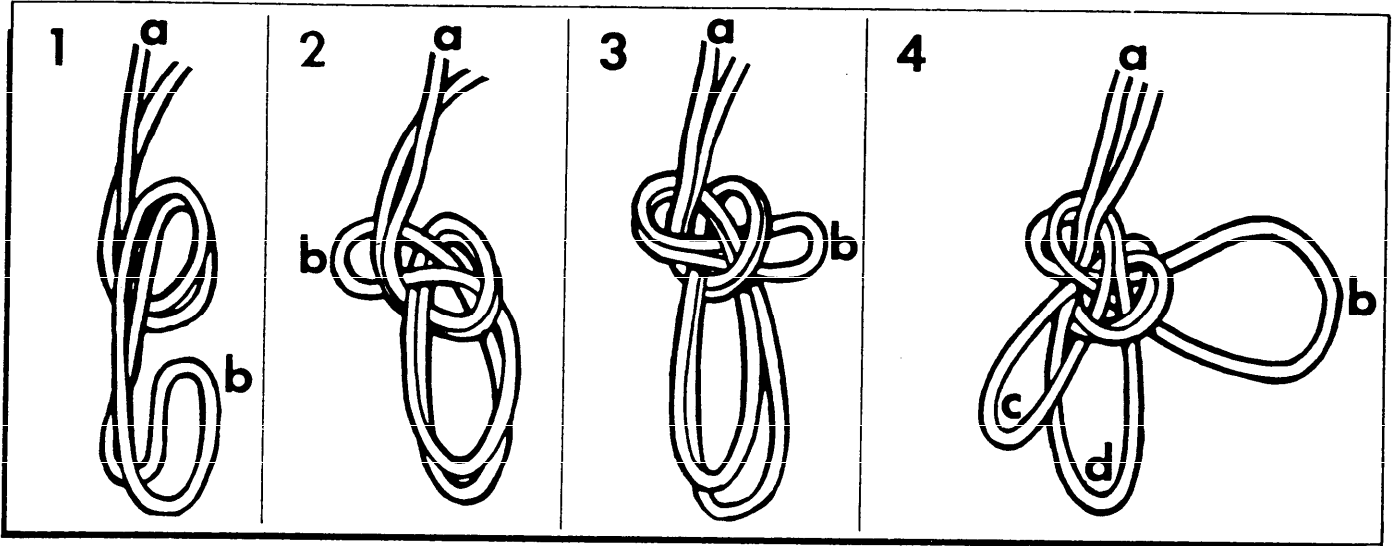

Figure 17-39. Double Bowline.

(2) Double Bowline. The double bowline (figure 17-39) with a slip knot is a rigging used by tree surgeons who work alone in trees for extended periods. It can be made and operated by one person and is comfortable as a sling or boatswain's chair (figure 17-40). A small board with notches as a seat adds to the personal comfort of the user. To tie a double bowline, the running end (a) (figure 17-39) of a line should be bent back about 10 feet along the standing part. The bight (b) is formed as the new running end and a bowline tied as described and illustrated in figure 17-38. The new running end (b) (figure 17-39) or loop is used to support the back and the remaining two loops (c) and (d) support the legs.

(3) Rolling or Magnus Hitch (figure 17-41). A rolling or Magnus hitch is a safety knot designed to make a running end fast to a suspension line with a nonslip grip yet it can be released by hand pressure bending the knot downward. The running end (a) (figure 17-41-1) is passed around the suspension line (b) twice, making two full turns downward (figure 17-41-2). The running end

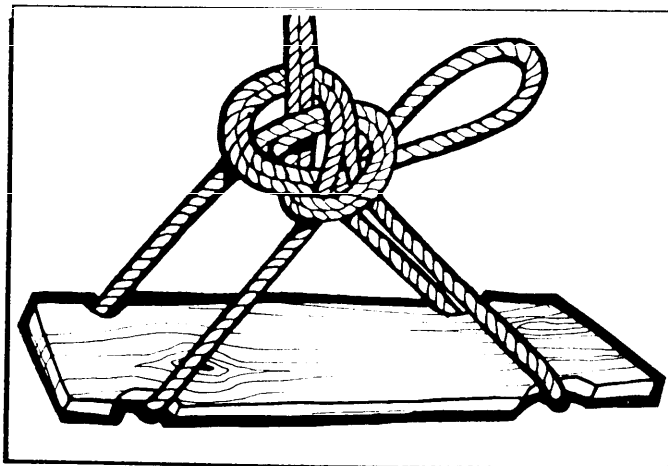

Figure 17-40. Boatswain's Chair.

(a) (figure 17-41-3) is then turned upward over the two turns, again around the suspension line, and under itself (figure 17-41-3). This knot is excellent for fastening a rope to itself, a larger rope, a cable, a timber, or a post.

(4) Running Bowline. The running bowline (figure 17-42) is the basic air transport rigging knot. It provides a sling of the choker type at the end of a single line and is generally used in rigging. To tie a running bowline, make a bight (b) (figure 17-42-1) with an overhand loop (c) made in the running end (a). The running end (a) is passed around the standing part, through the loop (c) (figure 17-42-2), under, then back over the side of the bight, and back through the loop (c) (figure 17-42-3).

(5) Bowline on a Bight. It is sometimes desirable to form a loop at some point in a rope other than at the end. The bowline on a bight (figure 17-43) can be used

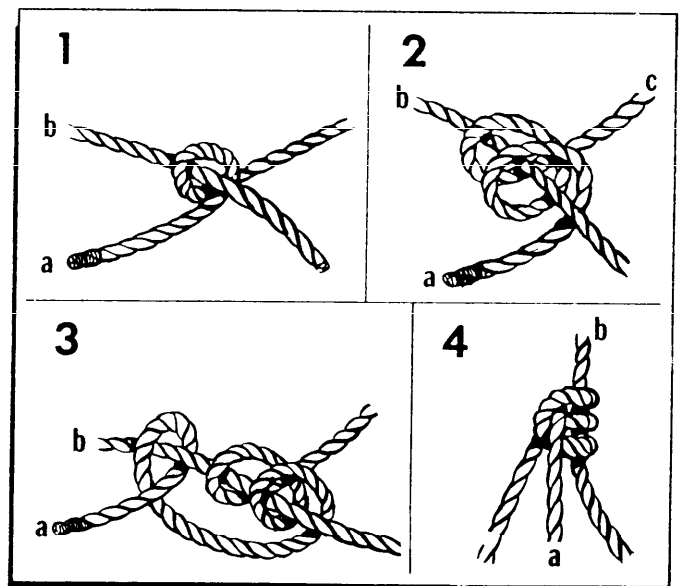

Figure 17-41. Rolling or Magnus Hitch.

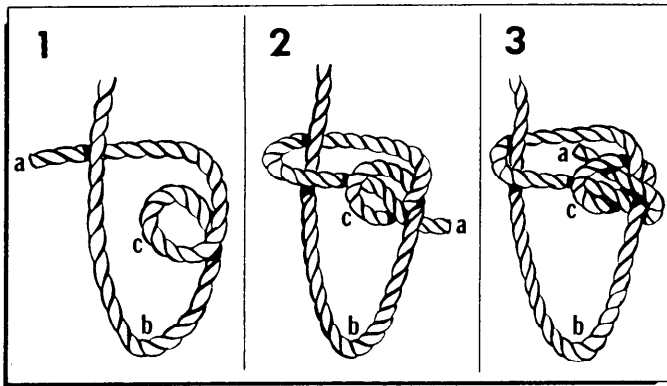

Figure 17-42. Running Bowline.

for this purpose. It is easily untied and will not slip. The same knot can be tied at the end of the rope by doubling the rope for a short section. A doubled portion of the rope is used to form a loop (b) (figure 17-43-1) as in the case of the bowline. The bight end (a) of the doubled portion is passed up through the loop (b), back down (figure 17-43-2), up around the entire knot (figure 17-43-3), and tightened (figure 17-43-4).

(6) Spanish Bowline. A Spanish bowline (figure 17-44) can be tied at any point in a rope, either at a

place where the line is doubled or at an end which has been doubled back. The Spanish bowline is used in rescue work or to give a two-fold grip for lifting a pipe or other round object in a sling. To tie the Spanish bowline, a doubled portion of the rope is held in the left hand with the loop up and the center of the loop is turned back against the standing parts to form two loops (figure 17-44-1) or "rabbit ears." The two rabbit ears (c) and (d) (figure 17-44-2) are moved until they partly overlap each other. The top of the loop nearest the person is brought down toward the thumb of the left hand, being sure it is rolled over as it is brought down. The thumb is placed over this loop (figure 17-44-5) to hold it in position. The top of the remaining loop is grasped and brought down, rolling it over and placing it under the thumb. There are now four small loops, (c, d, e, and f) in the rope. The lower left-hand loop (c) is turned one-half turn and inserted from front to back of the upper left-hand loop (e). The lower right-hand loop (d) is turned (figure 17-44-4) and inserted through the upper right-hand loop (f). The two loops (c and d) which have been passed through are grasped and the rope pulled tight (figure 17-44-5).

(7) French Bowline. The French bowline (figure 17-45) is sometimes used as a sling for lifting injured

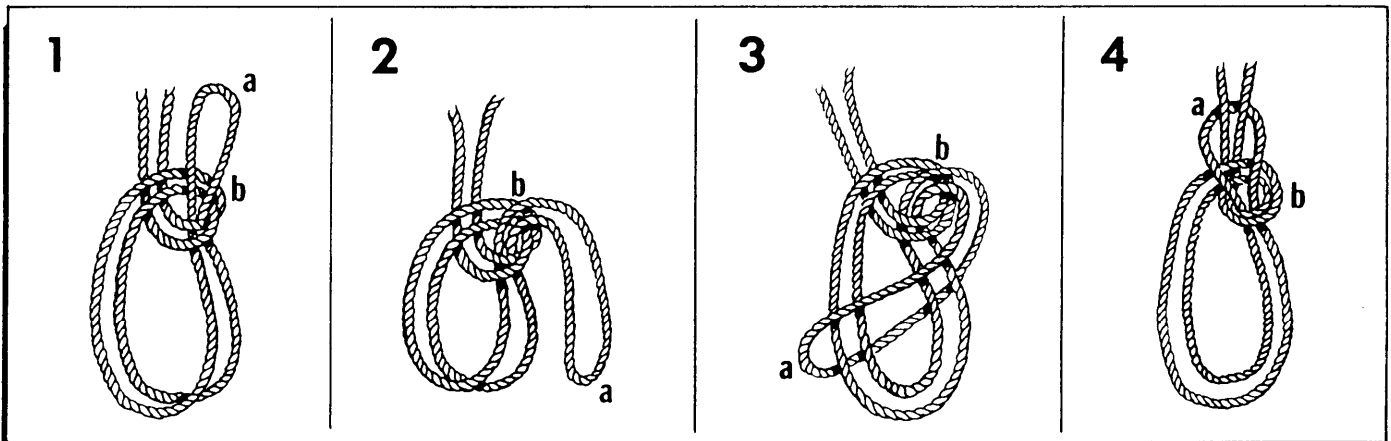

Figure 17-43. Bowline on a Bight.

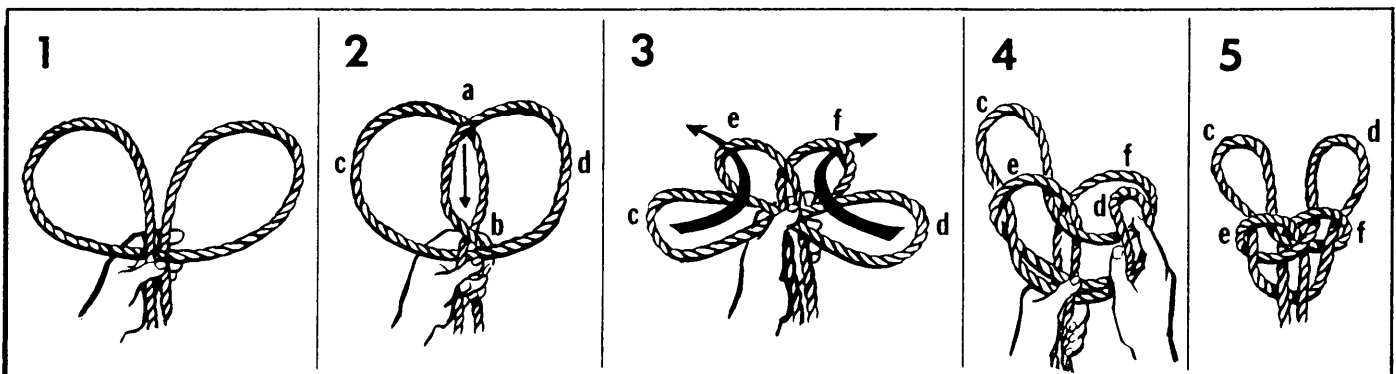

Figure 17-44. Spanish Bowline.

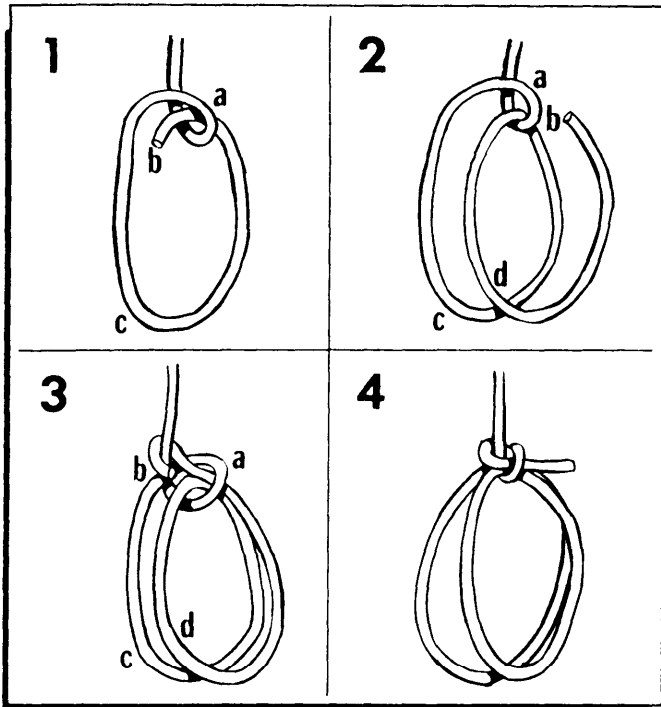

Figure 17-45. French Bowline.

people. When used in this manner, one loop is used as a seat and the other loop is used around the body under the arms. The weight of the injured person keeps the two loops tight so that the victim cannot fall out and for this reason, it is particularly useful as a sling for someone who is unconscious. The French bowline is started in the same way as the simple bowline. Make a loop (a) (figure 17-45-1) in the standing part of the rope. The running end (b) is passed through the loop from underneath and a separate loop (c) is made. The running end (b) is passed through the loop (a), again from underneath (figure 17-45-3), around the back of the standing part and back through the loop (a) so that it comes out parallel to the looped portion. The standing part of the rope is pulled to tighten the knot (figure 17-45-4), leaving two loops (c and d).

(8) Harness Hitch. The harness hitch (figure 17-46) is used to form a nonslipping loop in a rope. To make

the harness hitch, form a bight (a) (figure 17-46-1) in the running end of the rope. Hold this bight in the left hand and form a second bight (b) in the standing part of the rope. The right hand is used to pass bight (b) over bight (a) (figure 17-46-2). Holding all loops in place with the left hand, the right hand is inserted through bight (a) behind the upper part of bight (b) (figure 17-46-3). The bottom (c) of the first loop is grasped and pulled up through the entire knot (figure 17-46-4), pulling it tight.

g. Hitches:

(1) Half Hitch. The half hitch (figure 17-47-1) is used to tie a rope to a timber or to another larger rope. It is not a very secure knot or hitch and is used for temporarily securing the free end of a rope. To tie a half hitch, the rope is passed around the timber, bringing the running end around the standing part, and back under itself.

(2) Timber Hitch. The timber hitch (figure 17-47-2) is used for moving heavy timbers or poles. To make the timber hitch, a half hitch is made and similarly the running end is turned about itself at least another time. These turns must be taken around the running end itself or the knot will not tighten against the pull.

(3) Timber Hitch and Half Hitch. To get a tighter hold on heavy poles for lifting or dragging a timber hitch and half hitch are combined (figure 17-47-3). The running end is passed around the timber and back under the standing part to form a half hitch. Further along the timber, a timber hitch is tied with the running end. The strain will come on the half hitch and the timber hitch will prevent the half hitch from slipping.

(4) Clove Hitch. A clove hitch (figure 17-47-4) is used to fasten a rope to a timber, pipe, or post. It can be tied at any point in a rope. To tie a clove hitch in the center of the rope, two turns are made in the rope close together. They are twisted so that the two loops lay back-to-back. These two loops are slipped over the timber or pipe to form the knot. To tie the clove hitch at the end of a rope, the rope is passed around the timber in two turns so that the first turn crosses the standing part and the running end comes up under itself on the second turn.

(5) Two Half Hitches. A quick method for tying a rope to a timber or pole is the use of two half hitches.

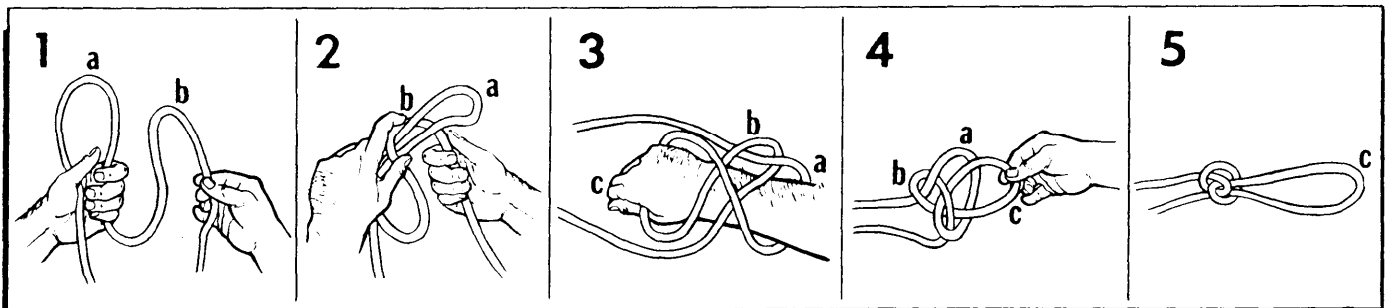

Figure 17-46. Harness Hitch.

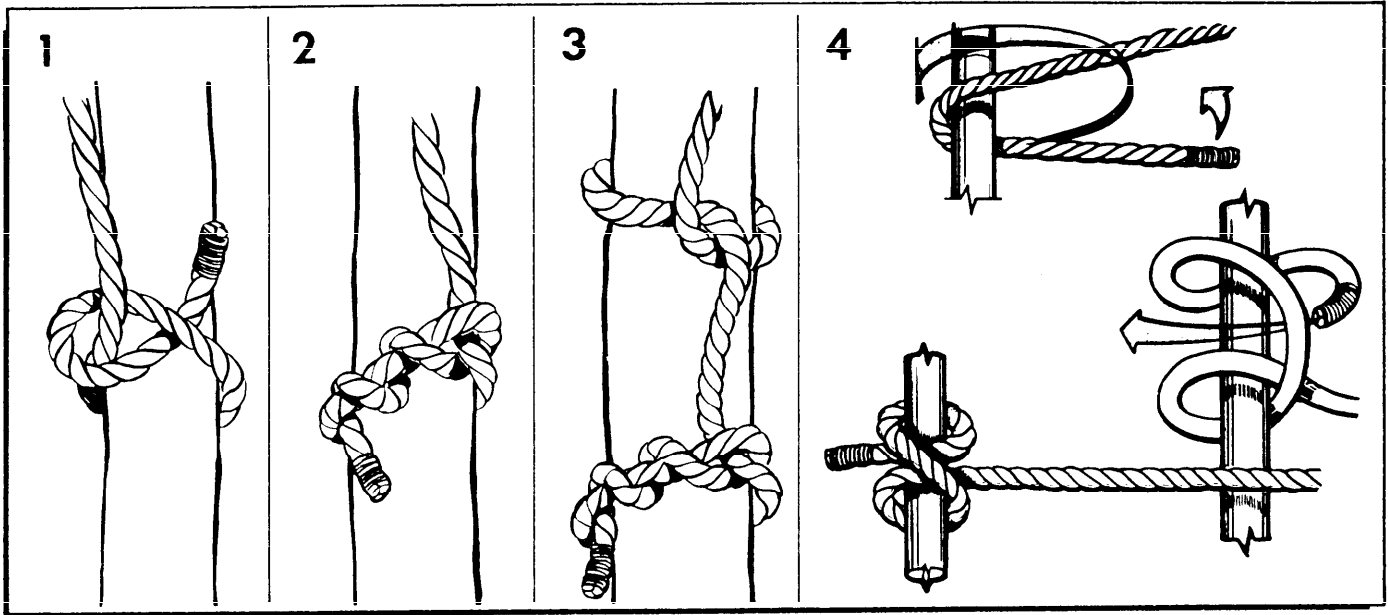

Figure 17-47. Half Hitch, Timber Hitch, and Clove Hitch.

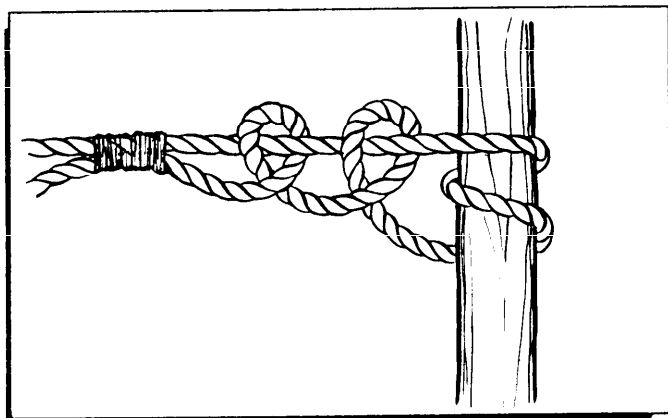

Figure 17-48. Round Turn and Two Half Hitches.

The running end of the rope is passed around the pole or timber, and a turn is taken around the standing part and under the running end. This is one half hitch. The running end is passed around the standing part of the rope and back under itself again.

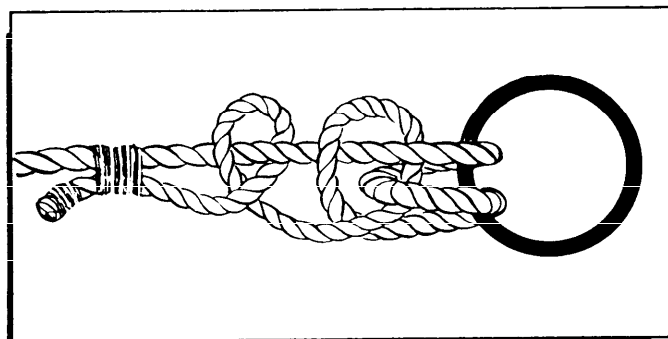

Figure 17-49. Fisherman's Bend.

(6) Round Turn and Two Half Hitches. Another hitch used for fastening a rope to a pole, timber, or spar is the round turn and two half hitches (figure 17-48). The running end of the rope is passed around the pole or spar in two complete turns, and the running end is brought around the standing part and back under itself to make a half hitch. A second half hitch is made. For greater security, the running end of the rope should be secured to the standing part.

(7) Fisherman's Bend. The fisherman's bend (figure 17-49) is used to fasten a cable or rope to an anchor, or for use where there will be a slackening and tightening motion in the rope. To make this bend, the running end of the rope is passed in two complete turns through the

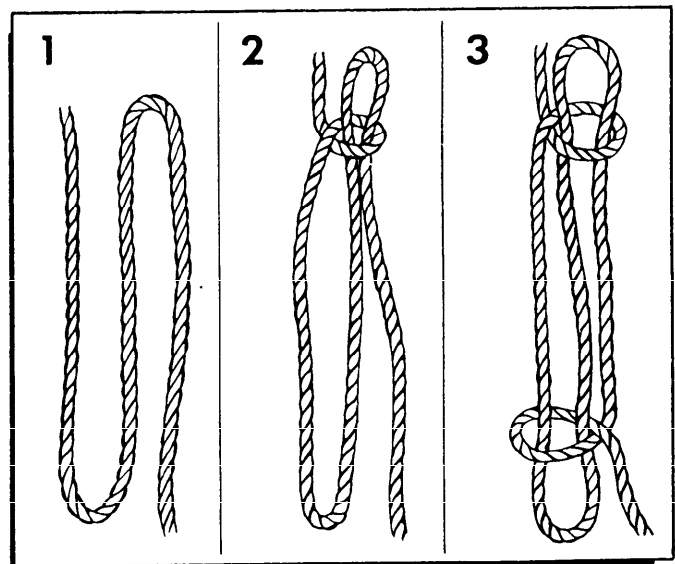

Figure 17-50. Sheep Shank.

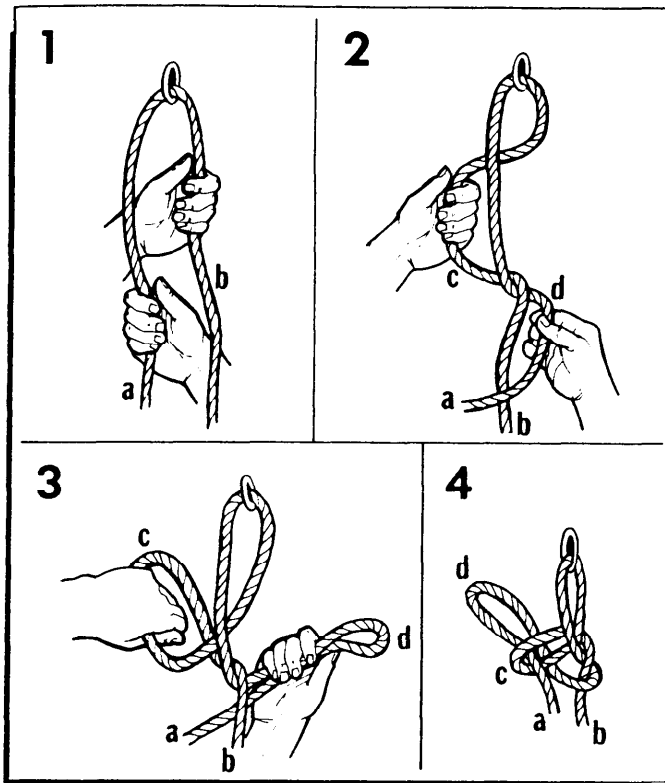

Figure 17-51. Speir Knot.

ring or object to which it is to be secured. The running end is passed around the standing part of the rope and through the loop which has just been formed around the ring. The running end is then passed around the standing part in a half hitch. The running end should be secured to the standing part.

(8) Sheepshank. A sheepshank (figure 17-50) is a method of shortening a rope, but it may also be used to take the load off a weak spot in the rope. To make the sheepshank (which is never made at the end of a rope), two bights are made in the rope so that three parts of the rope are parallel. A half hitch is made in the standing part over the end of the bight at each end.

(9) Speir Knot. A Speir knot (figure 17-51) is used when a fixed loop, a nonslip knot, and a quick release are required. It can be tied quickly and released by a pull on the running end. To tie the Speir knot, the

running end (a) is passed through a ring (figure 17-51-1) or around a pipe or post and brought back on the left side of the standing part (b). Both hands are placed, palms up, under both parts of the rope with the left hand higher than the right hand; grasping the standing part (b) with the left hand and the running end (a) with the right hand. The left hand is moved to the left and the right hand to the right (figure 17-51-3) to form two bights (c and d). The left hand is twisted a half turn toward the body so that bight (c) is twisted into a loop (figure 17-51-3). Pass bight (d) over the rope and down through the loop (c). The Speir knot is tightened by pulling on the bight (d) and the standing part (b) (figure 17-51-4).

(10) Rolling Hitch (Pipe or Pole). The rolling hitch (pipe or pole) (figure 17-52) is used to secure a rope to a pipe or pole so that the rope will not slip. The standing part (a) of the rope is placed along the pipe or pole (figure 17-52-1) extending in the direction opposite to the direction the pipe or pole will be moved. Two turns (b) are taken with the running end around the standing part (a) and the pole (figure 17-52-3). The standing part (a) of the rope is reversed so that it is leading off in the direction in which the pole will be moved (figure 17-52-3) and two turns taken (c) (figure 17-52-4) with the running end (d). On the second turn around, the running end (d) is passed under the first turn (c) to secure it. To make this knot secure, a half hitch (e) (figure 17-52-6) is tied with the standing part of the rope 1 or 2 feet above the rolling hitch.

(11) Blackwall Hitch. The blackwall hitch (figure 17-53) is used for fastening a rope to a hook. To make the blackwall hitch, a bight of the rope is placed behind the hook. The running end (a) and standing part (b) are crossed through the hook so that the running end comes out at the opposite side of the hook and under the standing part.

(12) Catspaw. A catspaw can be made at the end of a rope (figure 17-54) for fastening the rope to a hook. Grasp the running end (a) of the rope in the left hand and make two bights (c and d) in the standing part (b). Hold these two bights in place with the left hand and take two turns about the junction of the two bights with the standing part of the rope. Slip the two loops (c and d) so formed over the hook.

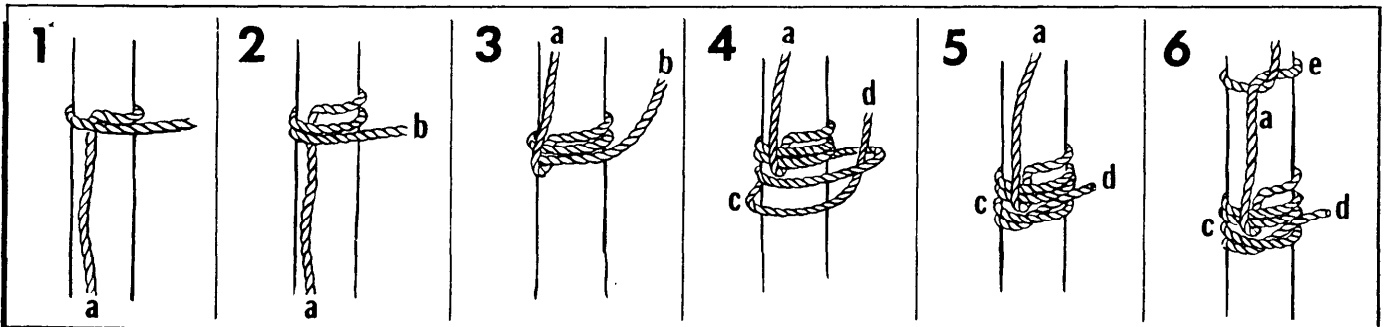

Figure 17-52. Rolling Hitch.

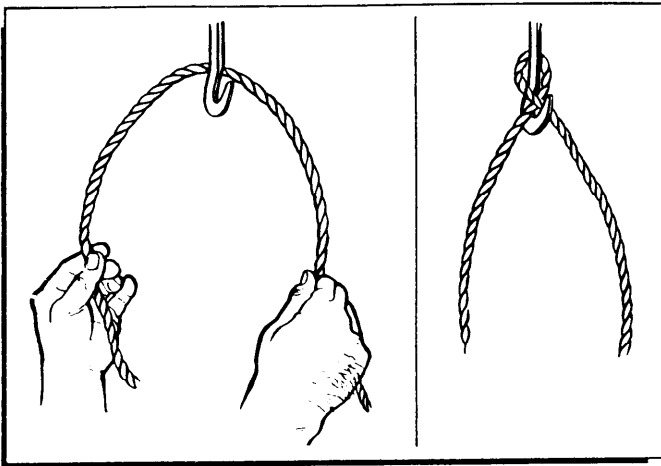

Figure 17-53. Blackwall Hitch.

(13) Scaffold Hitch. The scaffold hitch (figure 17-55) is used to support the end of a scaffold plank with a single rope. To make the scaffold hitch, the running end of the rope is layed across the top and around the plank, then up and over the standing part (figure 17-55-1). A doubled portion of the running end is brought back under the plank (figure 17-55-2) to form a

bight (b) at the opposite side of the plank. The running end is taken back across the top of the plank (figure 17-55-3) until it can be passed through the bight (b). A loop is made (c) in the standing part (figure 17-55-4) above the plank. The running end is passed through the loop (c) around the standing part, and back through the loop (c).

(14) Barrel Slings. Barrel slings can be made to hold barrels horizontally or vertically. To sling a barrel horizontally (figure 17-56), a bowline is made with a long bight. The rope at the bottom of the bight is brought up over the sides of the bight. The two "ears" are thus moved forward over the end of the barrel. To sling a barrel vertically (figure 17-57) the rope is passed under the barrel and up to the top. An overhand knot is made (a) on top (figure 17-57-1). With a slight tension on the rope, the two parts (figure 17-57-2) of the overhand knot are grasped, separated and pulled down to the center of the barrel (b and c). The rope is pulled snug and a bowline tied (d) over the top of the barrel (figure 17-57-3).

h. Lashing. There are numerous items which require lashings for construction; for example, shelters, equipment racks, and smoke generators. Three types of lash-

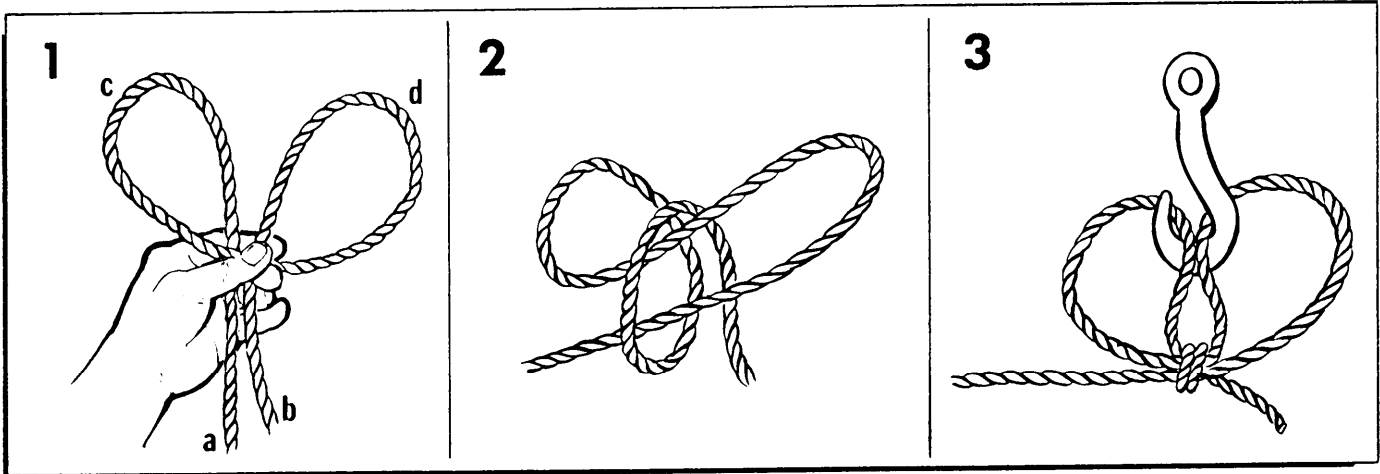

Figure 17-54. Catspaw.

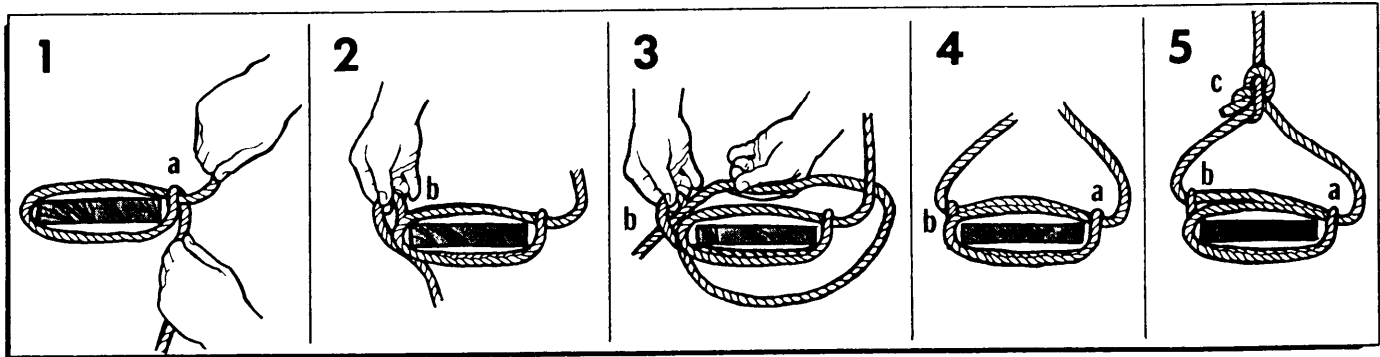

Figure 17-55. Scaffold Hitch.

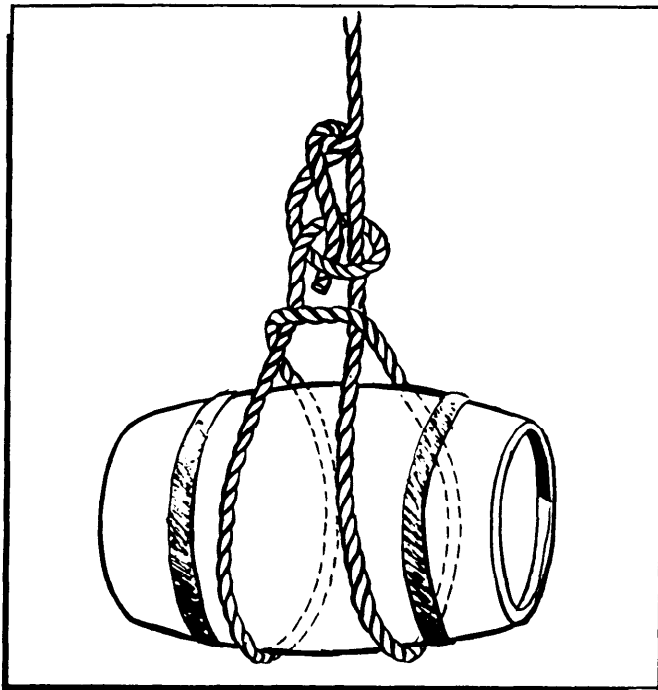

Figure 17-56. Barrel Slung Horizontally.

ings will be discussed here—the square lash, the diagonal lash, and the shear lash.

(1) Square Lash. Square lashing is started with a clove hitch around the log, immediately under the place where the crosspiece is to be located (figure 17-58-1). In laying the turns, the rope goes on the outside of the previous turn around the crosspiece, and on the inside of the previous turn around the log. The rope should be kept tight (figure 17-58-2). Three or four turns are necessary. Two or three “frapping” turns are made between the crosspieces (figure 17-58-3). The rope is pulled tight; this will bind the crosspiece tightly together. It is finished with a clove hitch around the same piece that the lashing was started on (figure 17-58-4). The square lash

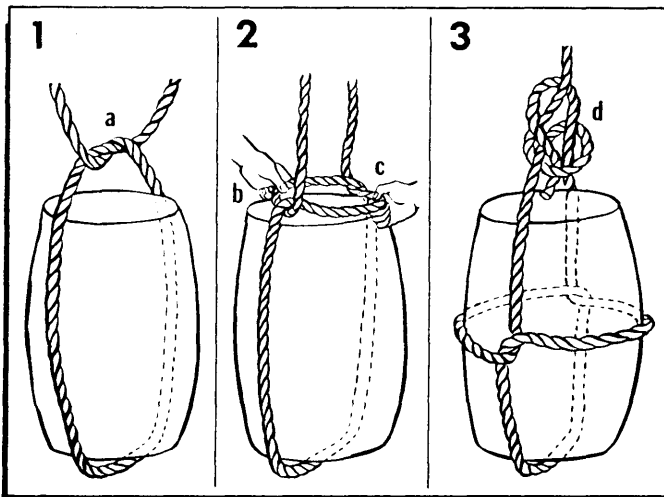

Figure 17-57. Barrel Slung Vertically.

is used to secure one pole at right angles to another pole. Another lash that can be used for the same purpose is the diagonal lash.

(2) Diagonal Lash. The diagonal lash is started with a clove hitch around the two poles at the point of crossing. Three turns are taken around the two poles (figure 17-59-1). The turns lie beside each other, not on top of each other. Three more turns are made around the two poles, this time crosswise over the previous turns. The turns are pulled tight. A couple of frapping turns are made between the two poles, around the lashing turns, making sure they are tight (figure 17-59-2). The lashing is finished with a clove hitch around the same pole the lash was started on (figure 17-59-3).

(3) Shear Lash. The shear lash is used for lashing two or more poles in a series. The desired number of poles are placed parallel to each other and the lash is started with a clove hitch on an outer pole (figure 17-60-1). The poles are then lashed together, using seven or eight turns of the rope laid loosely beside each other (figure 17-60-2). Make frapping turns between each pole (figure 17-60-3). The lashing is finished with a clove hitch on the pole opposite that on which the lash was started (figure 17-60-4).

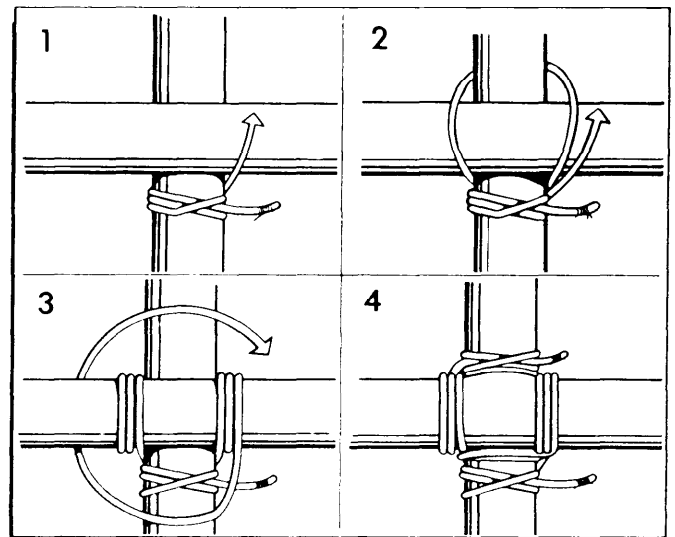

Figure 17-58. Square Lash.

i. Making Ropes and Cords. Almost any natural fibrous material can be spun into good serviceable rope or cord, and many materials which have a length of 12 to 24 inches or more can be braided. Ropes up to 3 and 4 inches in diameter can be “laid” by four people, and tensile strength for bush-made rope of 1-inch diameter range from 100 pounds to as high as 3,000 pounds.

(1) Tensile Strength. Using a three-lay rope of 1-inch diameter as standard, the following table of tensile strengths may serve to illustrate general strengths of various materials. For safety’s sake, the lowest figure should always be regarded as the tensile strength.

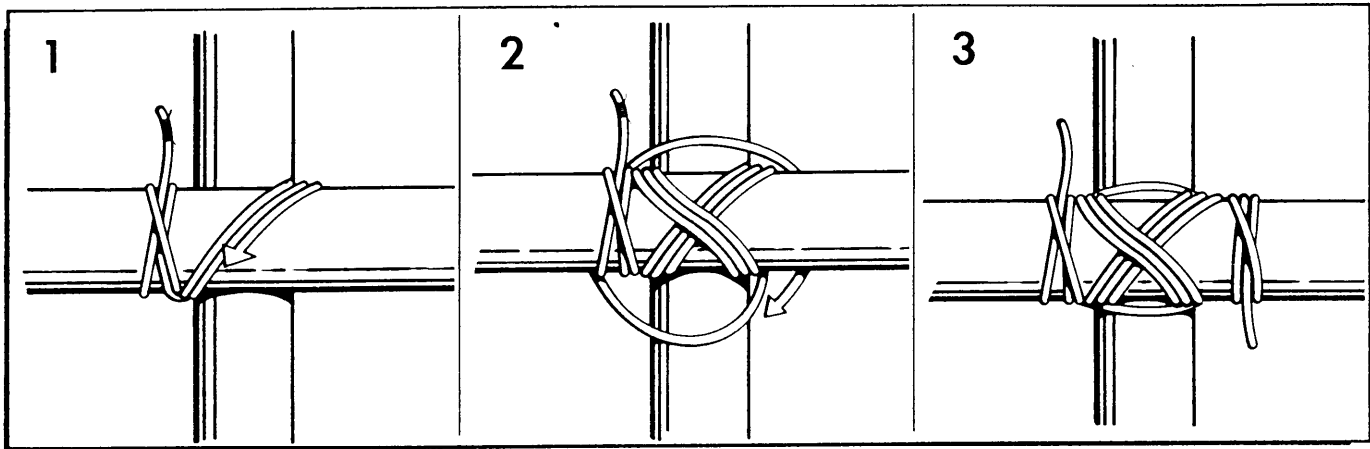

Figure 17-59. Diagonal Lash.

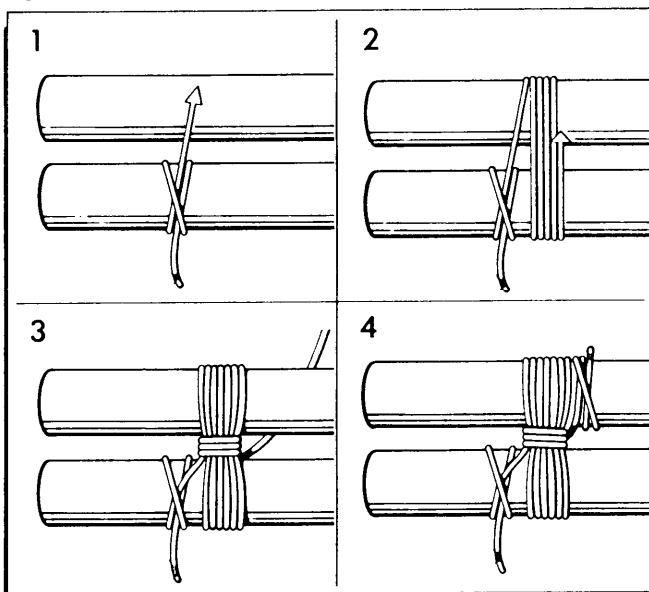

Figure 17-60. Shear Lash.

Green Grass	100 lbs to 250 lbs
Bark Fiber	500 lbs to 1,500 lbs
Palm Fiber	650 lbs to 2,000 lbs
Sedges	2,000 lbs to 2,500 lbs
Monkey Rope (Lianas)	560 lbs to 700 lbs
Lawyer Vine (Calamus)	1/2-inch diam, 1,200 lbs

NOTE: Doubling the diameter quadruples the tensile strength half the diameter reduces the tensile strength to one-fourth.

(2) Principles of Ropemaking Materials. To discover whether a material is suitable for rope making, it must have four qualities:

- (a) It must be reasonably long in the fiber.
- (b) It must have "strength."
- (c) It must be pliable.
- (d) It must have "grip" so the fibers will "bite" onto one another.

(3) Determining Suitability of Material. There are simple tests to determine if a material is suitable:

(a) First, pull on a length of the material to test for strength.

(b) Second, twist it between the fingers and "roll" the fibers together; if it will withstand this and not "snap" apart, an overhand knot is tied and gently tightened. If the material does not cut upon itself, but allows the knot to be pulled taut, it is suitable for ropemaking if the material will "bite" together and is not smooth or slippery.

(4) Where to Find Suitable Material. These qualities can be found in various types of plants, in ground vines, in most of the longer grasses, in some of the water reeds and rushes, in the inner barks of many trees and shrubs, and in the long hair or wool of many animals.

(5) Obtaining Fibers for Making Ropes. Some green freshly gathered materials may be "stiff" or unyielding. When this is the case, it should be passed through hot flames for a few moments. The heat treatment should cause the sap to burst through some of the cell structure, and the material thus becomes pliable. Fibers for rope making may be obtained from many sources such as:

- (a) Surface roots of many shrubs and trees have strong fibrous bark.
- (b) Dead inner bark of fallen branches of some species of trees and in the new growth of many trees such as willows.
- (c) The fibrous material of many water and swamp growing plants and rushes.
- (d) Many species of grass and weeds.
- (e) Some seaweeds.
- (f) Fibrous material from leaves, stalks, and trunks of many palms.
- (g) Many fibrous-leaved plants such as the aloes.

(6) Gathering and Preparing Materials. There may be a high content of vegetable gum in some plants. This can often be removed by soaking the plants in water, by

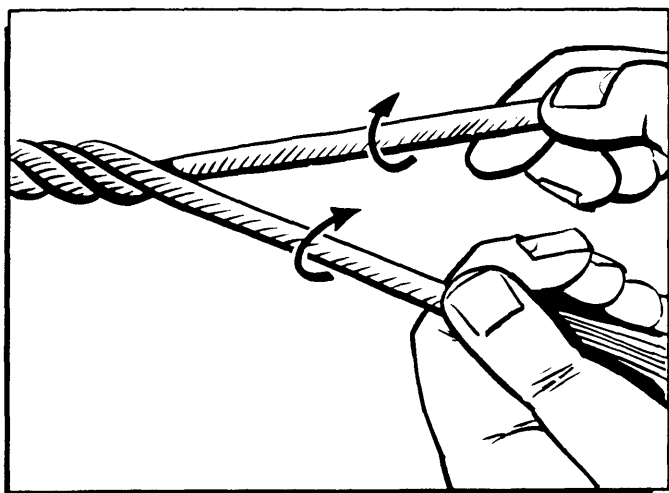

Figure 17-61. Twisting Fibers.

boiling, or by drying the material and “teasing” it into thin strips.

(a) Some of the materials have to be used green if any strength is required. The materials that should be green include the sedges, water rushes, grasses, and lianas.

(b) Palm fiber is harvested in tropical or subtropical regions. It is found at the junction of the leaf and the palm trunk, or it will be found lying on the ground beneath many palms. Palm fiber is a “natural” for making ropes and cords.

(c) Fibrous matter from the inner bark of trees and shrubs is generally more easily used if the plant is dead or half dead. Much of the natural gum will have dried out and when the material is being teased, prior to spinning, the gum or resin will fall out in fine powder.

(7) Making a Cord by Spinning with the Fingers:

(a) Use any material with long strong threads or fibers which have been previously tested for strength and pliability. The fibers are gathered into loosely held strands of even thickness. Each of these strands is twisted clockwise. The twist will hold the fibers together. The strands should be formed one-eighth inch diameter. As a general rule, there should be about 15 to 20 fibers to a strand. Two, three, or four of these strands are later twisted together, and this twisting together or “laying” is done with a counterclockwise twist, while at the same time, the separate strands which have not yet been laid up are twisted clockwise. Each strand must be of equal twist and thickness.

(b) Figure 17-61 shows the general direction of twist and the method whereby the fibers are bonded into strands. In a similar manner, the twisted strands are put together into lays, and the lays into ropes.

(c) The person who twists the strands together is called the “layer” and must see that the twisting is even, the strands are uniform, and the tension on each strand is equal. In “laying,” care must be taken to ensure each

of the strands is evenly “laid up;” that is, one strand does not twist around the other one.

(d) When spinning fine cords for fishing lines, snares, etc., considerable care must be taken to keep the strands uniform and the lay even. Fine thin cords of no more than $\frac{1}{32}$ -inch thickness can be spun with the fingers and are capable of taking a breaking strain of 20 to 30 pounds or more.

(e) Normally two or more people are required to spin and lay up the strands for cord. However, many native people spin cord unaided. They twist the material by running the flat of the hand along the thigh, with the fibrous material between hand and thigh; and with the free hand, they feed in fiber for the next “spin.” Using this technique, one person can make long lengths of single strands. This method of making cord or rope with the fingers is slow if any considerable length of cord is required.

(f) An easier and simpler way to rapidly make lengths of rope from 50 to 100 yards or more in length is to make a rope machine and set up multiple spinners in the form of cranks. Figure 17-62 shows the details of rope spinning.

(g) To use a rope machine, each feeder holds the material under one arm and with one free hand feeds it into the strand which is being spun by the crank. The other hand lightly holds the fibers together till they are spun. As the lightly spun strands are increased in length, they must be supported on crossbars. They should not be allowed to lie on the ground. Spin strands from 20 to 100 yards before laying up. The material should not be spun in too thickly. Thick strands do not help strength in any way, rather, they tend to make a weaker rope.

(8) Setting Up a Rope Machine:

(a) When spinning ropes of 10 yards or longer, it is necessary to set crossbars every 2 or 3 yards to carry the strands as they are spun. If crossbars are not set up, the strands or rope will sag to the ground, and some of the fibers will tangle up with grass, twigs, or dirt on the ground. Also, the twisting of the free end may either be stopped or interrupted and the strand will be unevenly twisted.

(b) The easiest way to set up crossbars for the rope machine is to drive pairs of stakes into the ground about 6 feet apart and at intervals of about 6 to 10 feet. The crossbars must be smooth and free from twigs and loose portions of bark that might twist in with the spinning strands.

(c) The crossbar (a) is supported by two uprights and pierced to take the cranks (b). These cranks can be made out of natural sticks, morticed slab, and pegs, or if available, bent wire. The connecting rod (c) enables one person to turn all cranks clockwise simultaneously. Crossbars supporting the strands as they are spun are shown (d). A similar crank handle to the previous ones (b) is supported on a forked stick at the end of the rope

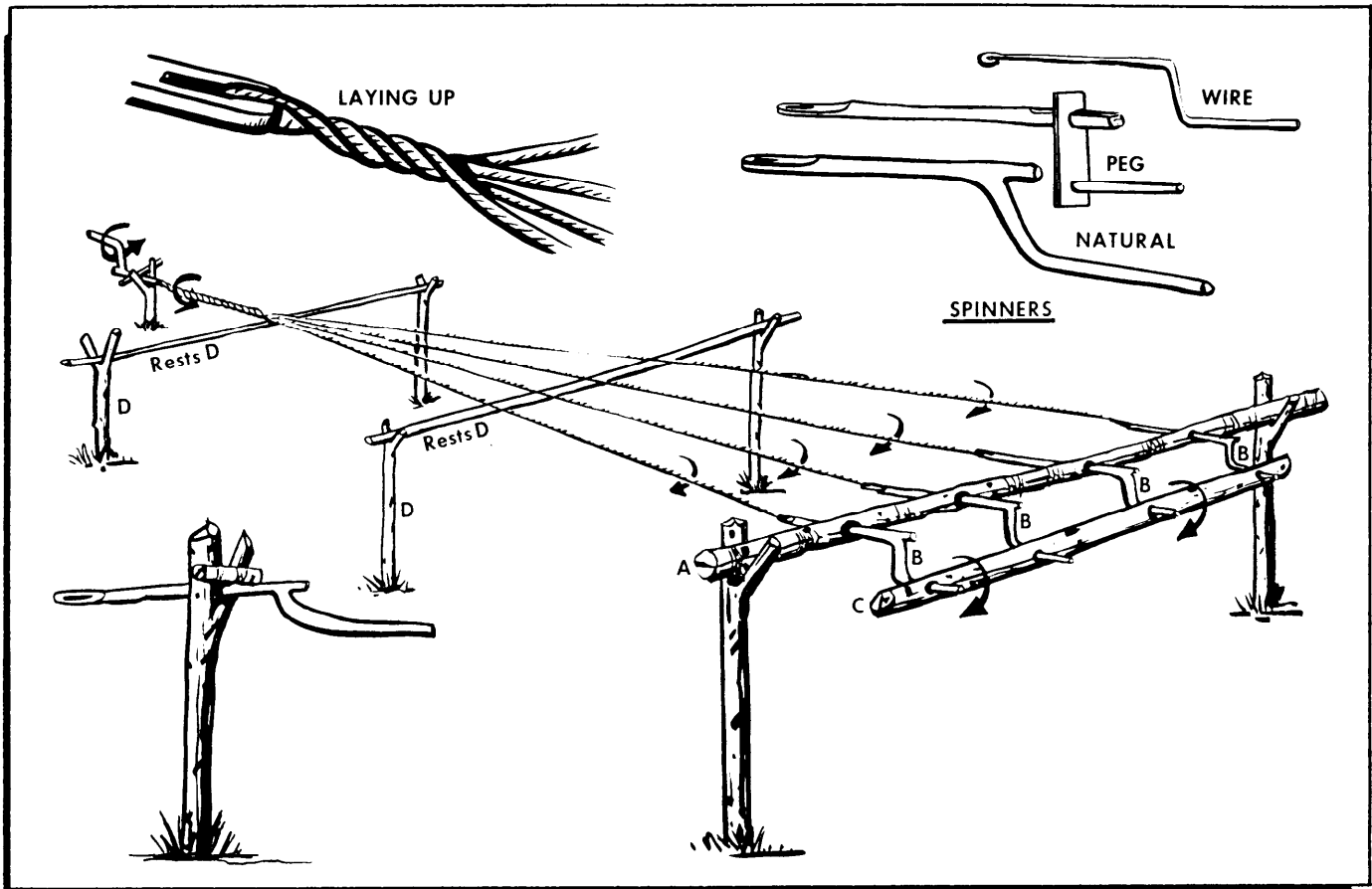

Figure 17-62. Rope Machine.

machine. This handle is turned in reverse (counterclockwise) to the cranks (c) to twist the connected strands together. These are "laid up" by one or more of the feeders.

(d) The first strand should be turned clockwise, then the laying up of the strands will be done counterclockwise and the next laying will again be clockwise. Proof that the rope is well made is that the individual fibers lay lengthways along the rope.

(e) In the process of laying up the strands, the actual twisting together or laying will take some of the original "twist" out of the strand which has not yet been laid. Therefore, it is necessary to keep twisting the strands while laying together.

(f) When making a rope too long to be spun and laid in one piece, a section is laid up and coiled on the ground at the end of the rope walk farthest from the cranks. Strands for a second length are spun, and these strands are married or spliced into the strands of the first section and then the laying up of the second section continues the rope.

(g) The actual "marrying" of the strands is done only in the last lay, which makes the rope when completed. The ends where the strands are married should be staggered in different places. By this means, rope can be made and extended in sections to a great length.

(h) After a complete length of rope is laid up, it should be passed through the fire to burn off the loose ends and fibers. This will make the rope smooth and more professional looking.

(9) Laying the Strands:

(a) The strands lie on the crossbar as they are spun. When the strands have been spun to the required length, which should not be more than about a hundred feet, they are joined together by being held at the far end. They are then ready for laying together. The turner, who is facing the cranks, twists the ends together counterclockwise, at the same time keeping full weight on the rope which is being laid up. The layer advances placing the strands side by side as they turn.

(b) It is important to learn to feed the material evenly, and lay up slowly, thereby getting a smooth even rope (figure 17-63). Do not try to rush the ropemaking. Speed in ropemaking only comes with practice. At first it will take a team of three or four up to 2 hours or more to make a 50-yard length of rope of three lays, each of three strands; that is, nine strands for a rope with a finished diameter of about 1 inch. With practice, the same three or four people will make the same rope in 15 to 20 minutes. These times do not include time for gathering material.

(c) In feeding the free ends of the strands, twist in the loose material fed in by the feeder. As the feeders move backward, they must keep a slight tension on the strands.

(10) Making Rope with a Single Spinner:

(a) Using a Single Crank. Two people can make a rope, using a single crank. A portion of the material is fastened to the eye of the crank, as with the multiple crank. Supporting crossbars, as used in a ropewalk, are required when a length of more than 20 or 30 feet is being spun.

(b) Feeding:

-1. If the feeder is holding material under the left arm, the right hand is engaged in continuously pulling material forward to the left hand which feeds it into the turning strand. These actions, done together as the feeder walks backward, govern the thickness of the strands. The left hand, lightly closed over the loose turning material, must "feel" the fibers "biting" or twisting together.

-2. When the free end of the turning strand, which is against the loose material under the arm, takes in too thick a tuft of material, the left hand is closed, and so arrests the twist of the material between the left hand and the bundle. This allows teasing out the overall "bite," with the right hand, thus maintaining a uniform thickness of the spinning strand.

(c) Thickness of Strands. Equal thickness and twist for each of the strands throughout their length are important. The thickness should not be greater than is necessary with the material being used. For a grass rope, the strand should not be more than one-fourth inch diameter; for coarse bark or palm, not more than one-eighth or three-sixteenth inch; and for fine bark, hair, or sisal fiber, not more than one-eighth inch.

(d) Common Errors in Ropemaking:

-1. There is a tendency with beginners to feed unevenly. Thin wispy sections of strand are followed by

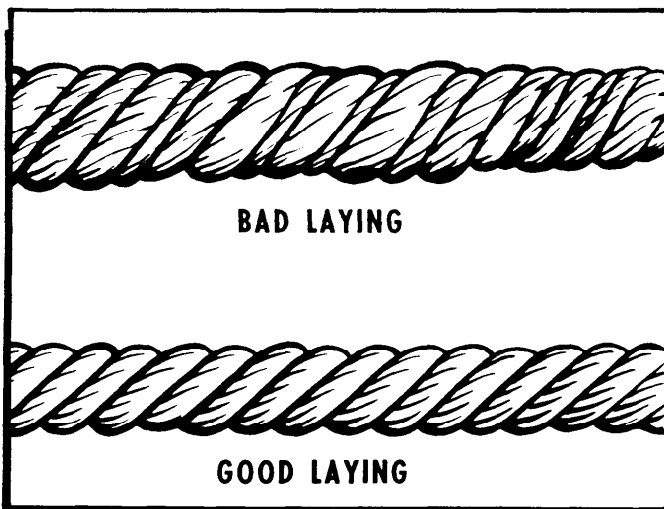

Figure 17-63. Rope Laying.

thick portions. Such feeding degrades the quality of rope. Rope made from such strands will break with less than one-fourth of the tensile strain on the material.

-2. Beginners are wise to twist and feed slowly. Speed, with uniformity of twist and thickness, comes with practice.

-3. Thick strands do not help. It is useless to try and spin a rope from strands an inch or more in thickness. Such a rope will break with less than half the tensile strain on the material. Spinning "thick" strands does not save time in ropemaking.

(e) Lianas, Vines, and Canes. Lianas and ground vines are natural ropes, and grow in subtropical and tropical scrub and jungle. Many are of great strength and useful for braiding, tree climbing, and other purposes. The smaller ground vines, when "braided", give great strength and flexibility. Canes and stalks of palms provide excellent material if used properly. Only the outer skin is tough and strong, and this skin will split off easily if the main stalk is bent away from the skin. This principle also applies to the splitting of lawyer cane (calamus), palm leaf stalks, and all green material. If the split starts to run off, bend the material away from the thin side, and it will gradually gain in size and come back to an even thickness with the other split side.

(f) Bark Fibers:

-1. The fibers in many barks which are suitable for "ropemaking" are located near the innermost layers. This is the bark next to the sap wood. When seeking suitable barks of green timber, cut a small section about 3 inches long and 1 inch wide. Cut this portion from the wood to the outer skin of the bark.

-2. The specimen should be peeled and the different layers tested. Green bark fibers are generally difficult to spin because of "gum" and it is better to search around for windfall dead branches and try the inner bark of these. The gum probably has leached out, and the fibers should separate easily.

-3. Many shrubs have excellent bark fiber, and here it is advisable to cut the end of a branch and peel off a strip of bark for testing. Thin bark from green shrubs is sometimes difficult to spin into fine cord and is easier to use as braid for small cords.

-4. Where it is necessary to use green bark fiber for rope spinning the gum will generally wash out when the bark is teased and soaked in water for a day or so. After removing from the water, the bark strips should be allowed to dry before shredding and teasing into fiber.

(11) Braiding. One person may require a length of rope. If there is no help available to spin materials, it is necessary to find reasonably long material. With this material, one person can braid and make suitable rope. The usual three-strand braid makes a flat rope, and while quite good, it does not have finish or shape, nor is it as "tight" as the four-strand braid. On other occa-

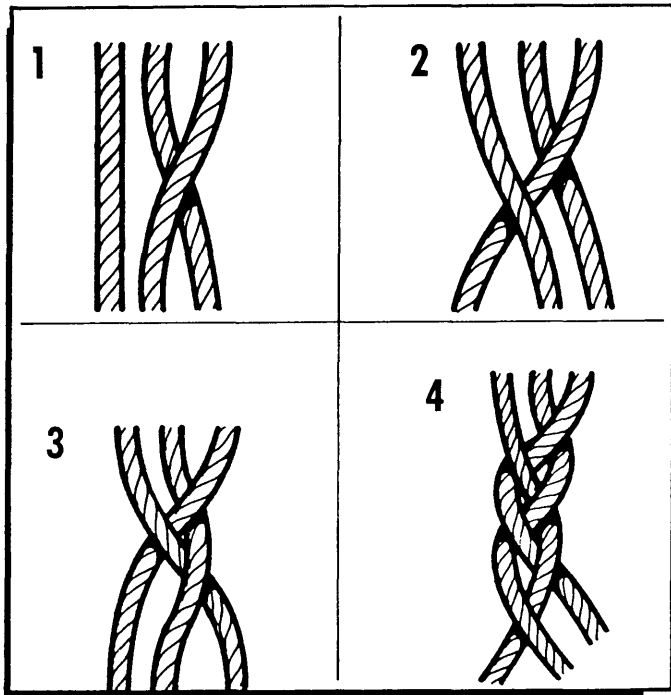

Figure 17-64. Three-Strand Braid.

sions, it may be necessary to braid broad bands for belts or for shoulder straps. There are many fancy braids which can be developed from these, but these three are basic, and essential for practical woodcraft work. A general rule for all braids is to work from the outside into the center.

(a) Three Plait:

- 1. The right-hand strand is passed over the strand to the left.

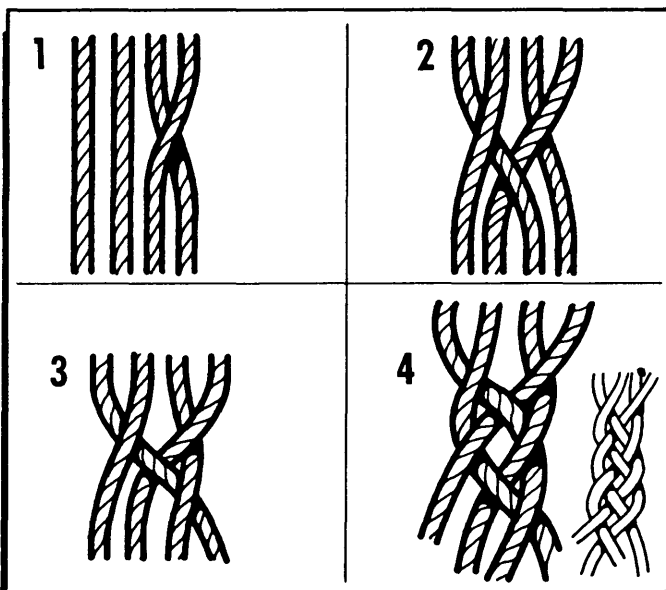

Figure 17-65. Four-Strand Braid.

- 2. The left-hand strand is passed over the strand to the right.
- 3. This is repeated alternately from left to right (figure 17-64).

(b) Flat Four-Strand Braid:

- 1. The four strands are placed side by side. The right-hand strand is taken (figure 17-65-1) and placed over the strand to the left.
- 2. The outside left-hand strand (figure 17-65-2) is laid under the next strand to itself and over what was the first strand.
- 3. The outside right-hand strand is laid over the first strand to its left (figure 17-65-3).
- 4. The outside left strand is placed under and over the next two strands, respectively, moving toward the right.
- 5. Thereafter, the right-hand strand goes over one strand to the left, and the left-hand strand under and over to the right (figure 17-65-4).

(c) Broad Braid. Six or more strands are held flat and together.

- 1. A strand in the center is passed over the next strand to the left, as in figure 17-66-1.
- 2. The second strand to the left of center is passed toward the right and over the first strand so that it points toward the right (figure 17-66-2).
- 3. The strand next to the first one is taken and woven under and over (figure 17-66-3).
- 4. The next strands are woven from left and right alternately towards the center (figure 17-66-4 through 6). The finished braid should be tight and close (figure 17-66-7).

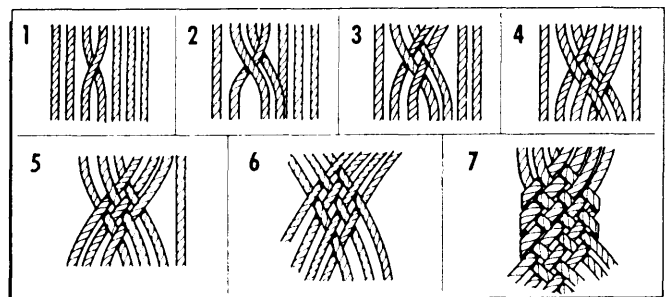

Figure 17-66. Broad Braid.

- 5. To finish the broad braid:
 - a. One of the center strands is laid back upon itself (figure 17-67-1).
 - b. Now take the first strand which it enclosed in being folded back, and weave this back upon itself (figure 17-67-2).
 - c. Strand from the opposite side is laid back and woven between the strands already braided (figure 17-67-3).

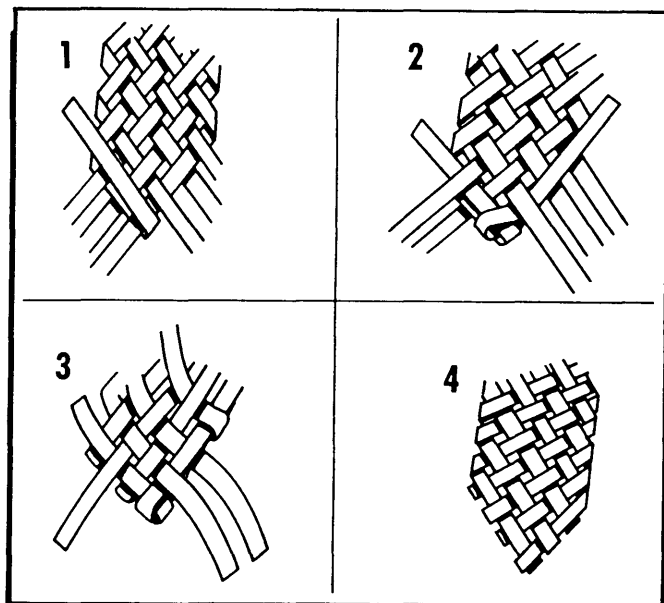

Figure 17-67. Finishing the Broad Braid.

-d. All the strands should be so woven back that no strands show an uneven pattern, and there should be a regular under-over-under of the alternating weaves (figure 17-67-4).

-e. If the braid is tight, there may be a difficulty in working the loose ends between the plaited strands.

-f. This can be done easily by sharpening a thin piece of wood to a chisel edge to open the strands sufficiently to allow the ends being finished to pass between the woven strands.

-g. It should be rolled under a bottle or other round object and made smooth for final finishing.

17-7. Personal Survival Kit:

a. Even though a survival kit may be available, aircrew members should consider assembling and carrying

personal survival kits. Survival experiences have occurred where survivors hit the ground running, and because of shock and fear left their survival kits behind. If survivors have a personal survival kit in a pocket, it may improve their survival chances considerably.

b. A great deal of thought should go into preparing personal survival kits. The potential needs of the survivors must be a consideration, such as the impact of the environmental elements, type of mission to be flown (tactical or nontactical), availability of rescue, and how far to friendly forces (figure 17-68).

c. There are two basic ways to carry a personal survival kit. One way is to pack all items into one or two waterproof containers. The other way is to scatter the items throughout personal clothing. Any type of small container can be used to encase the contents of the personal survival kit. Plastic cigarette cases, soap dishes, and Band-aid boxes are excellent containers.

d. Examples of items which can be packed into a small container are:

- (1) Matches.
- (2) Safety pins (varied sizes).
- (3) Fishhooks.
- (4) Knife (small, multibladed).
- (5) Button compass.
- (6) Prophylactic (for water container).
- (7) Bouillon cubes.
- (8) Salt.
- (9) Snare wire.
- (10) Water purification tablets.
- (11) Signal mirror.
- (12) Needles.
- (13) Band-aids.
- (14) Aluminum Foil.
- (15) Insect repellent stick.
- (16) Chapstick.
- (17) Soap (Antiseptic).

NOTE: All kits carried aboard the aircraft should be approved by the unit life support officer.

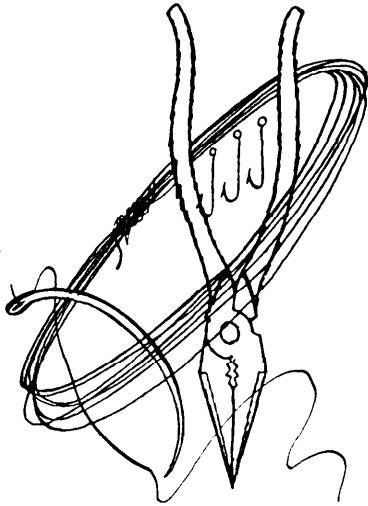

MINIMUM ESSENTIAL ITEMS

High quality pocket knife with at least two cutting blades.

Pocket compass.

Match safe with matches.

- Plastic or metallic container.
- Waterproof kitchen-type matches (cushion heads against friction), or
- Waterproof matches rolled in paraffin-soaked muslin in an easily opened container such as small soap box, toothbrush case, etc.

Needles — sailmakers, surgeons, and darning — at least one of each.

Assorted fishhooks in heavy foil, tin, or plastic holders.

Snare wire — small hank.

Needle-nosed pliers with side cutters; high quality.

Bar surgical soap or hand soap containing physohex.

Small fire starter of pyrophoric metal (some plastic match cases have a strip of the metal anchored on the bottom outside of the case).

Personal medicines.

Water purification tablets.

"Band-aids."

Insect repellent stick.

Chapstick.

GOOD TO HAVE ITEMS

*Pen-gun and flares.

*Colored cloth or scarf for signaling.

Stick-type skin dye (for camouflage).

Plastic water bottle.

*Flexible saw (wire saw).

*Sharpening stone.

Safety pins (several sizes).

Travel razor.

Small steel mirror.

6" flat bastard file.

Aluminum foil.

ADDITIONAL SUGGESTIONS

Toothbrush — small type.

Surgical tape.

Prophylactics (make good waterproof containers or canteens).

*Penlight with batteries.

Fishline.

*Fishline monofilament.

*Clear plastic bags.

Emergency ration can opener (can be taped shut and strung on dog tag chain).

Split shot — for fishing sinkers.

Gill net.

Small, high quality candles.

INDIVIDUAL MEDICAL KIT

Sterile gauze compress bandage.

Antibiotic ointment (Neomycin polymycin bacitracin ophthalmic ointment is good).

Tincture of zephrine — skin antiseptic.

Aspirin tablets.

Salt tablets.

Additional medications may be desirable, depending upon nature of the mission and an individual's particular personal needs.

This should be discussed with and procured from your local flight surgeon.

*Especially valuable.

Figure 17-68. Personal Survival Kit Items.

Part Six

SUSTENANCE

Chapter 18

FOOD

18-1. Introduction. Except for the water they drink and the oxygen they breathe, survivors must meet their body needs through the intake of food. This chapter will explore the relationship of proper nutrition to physical and mental efficiency. It is extremely important that survivors maintain a proper diet at all times. A nutritionally sound body stands a much better chance of surviving. Improper diet over a long period of time may lead to a lack of stamina, slower reactions, less resistance to illness, and reduced mental alertness, all of which can cost survivors their lives in a survival situation. A knowledge of the body's nutritional requirements will help survivors select foods to supplement their rations.

18-2. Nutrition. Survivors and evaders expend much more energy in survival situations than they would in the course of their normal everyday jobs and life. Basal metabolism is the amount of energy expended by the body when it is in a resting state. The rate of basal metabolism will vary slightly with regard to the sex, age, weight, height, and race of a person. The basic energy expended, or number of calories consumed by the hour will change as a person's activity level changes. A person who is simply sitting in a warm shelter, for example, may consume anywhere from 20 to 100 calories an hour, while that same person evading through thick undergrowth with a heavy pack, would expend a greater amount of energy. In a survival situation, proper food can make the difference between success and failure.

a. The three major constituents of food are carbohydrates, fats, and proteins. Vitamins and minerals are also important as they keep certain essential body processes in good working order. It is also necessary for survivors to maintain proper water and salt levels in their bodies, as they aid in preventing certain heat disorders.

(1) Carbohydrates. Carbohydrates are composed of very simple molecules which are easily digested. Carbohydrates lose little of their energy to the process of digestion and are therefore efficient energy suppliers. Because carbohydrates supply easily used energy, many nutritionists recommend that, if possible, survivors should try to use them for up to half of their calorie intake. Examples of carbohydrates are: starches, sugars, and cellulose. These can be found in fruits, vegetables, candy, milk, cereals, legumes, and baked goods. Cellu-

lose cannot be digested by humans, but it does provide needed roughage for the diet.

(2) Fats. Fats are more complex than carbohydrates. The energy contained in fats is more slowly released than the energy in carbohydrates. Because of this, it is a longer lasting form of energy. Fats supply certain fat-soluble vitamins. Sources of these fats and vitamins are butter, cheese, oils, nuts, egg yolks, margarine, and animal fats. If survivors eat fats before sleeping, they will sleep warmer. If fats aren't included in the diet of survivors, they can become run down and irritable. This can lead to both physical and psychological breakdown.

(3) Protein. The digestive process breaks protein down into various amino acids. These amino acids are formed into new body tissue protein, such as muscles. Some protein gives the body the exact amino acids required to rebuild itself. These proteins are referred to as "complete." Protein that lacks one or more of these essential amino acids is referred to as "incomplete." Incomplete protein examples are cheese, milk, cereal grains, and legumes. Incomplete protein, when eaten in combination with milk and beans for example, can supply an assortment of amino acids needed by the body. Some complete protein is found in fish, meat, poultry, and blood. No matter which type of protein is consumed, it will contain the most complex molecules of any food type listed.

(a) If possible, the recommended daily allowance of 2½ to 3 ounces complete protein should be consumed by each survivor each day. If only the incomplete protein is available, two, three, or even four types of foods may need to be eaten in combination so that enough amino acids are combined to form complete protein.

(b) If amino acids are introduced into the body in great numbers and some of them are not used for the rebuilding of muscle, they are changed into fuel or stored in the body as fat. Because protein contains the more complex molecules, over fats or carbohydrates, they supply energy after those forms of energy have been used up. A lack of protein causes malnutrition, skin and hair disorders, and muscle atrophy.

b. Vitamins occur in small quantities in many foods, and are essential for normal growth and health. Their chief function is to regulate the body processes. Vitamins can generally be placed into two groups: fat-soluble and water-soluble. The body only stores slight amounts of the water-soluble type. In a long survival episode where a routinely balanced diet is not available,

survivors must overcome food aversions and eat as much of a variety of vitamin-rich foods as possible. Often one or more of the four basic food groups (meat, fish, poultry; vegetables and fruits; grain and cereal; milk and milk products) are not available in the form of familiar foods, and vitamin deficiencies such as beriberi or scurvy result. If the survivor can overcome aversions to local foods high in vitamins, these diseases as well as signs and symptoms such as depression and irritability can be warded off.

c. Adequate minerals can also be provided by a balanced diet. Minerals build and (or) repair the skeletal system and regulate normal body functions. Minerals needed by the body include iodine, calcium, iron, and salt, to name but a few. A lack of minerals can cause problems with muscle coordination, nerves, water retention, and the ability to form or maintain healthy red blood cells.

d. For survivors to maintain their efficiency, the following number of calories per day is recommended. These figures will change because of individual differences in basal metabolism, weight, etc. During warm weather survivors should consume anywhere from 3,000 to 5,000 calories per day. In cold weather the calorie intake should rise from 4,000 to 6,000 calories per day. A familiarity with the calorie and fat amounts in foods is important for survivors to meet their nutritional needs. For example, it would take quite a few mussels and dandelion greens to meet those requirements. Survivors should attempt to be familiar enough with foods that they can select or find foods that provide a high calorie intake (figure 18-1).

(1) Survivors should also be familiar with the number of calories supplied by the food in issued rations. In most situations, rations will have to be supplemented with other foods procured by survivors. If possible, survivors should limit their activities to save energy. Rationing food is a good idea since survivors never know when their ordeal will end. They should eat when they can, keeping in mind that they should maintain at least a minimum calorie intake to satisfy their basic activity needs.

(2) Caloric and fat values of selected foods are shown in the chart, and unless otherwise specified, the foods listed are raw. Depending on how survivors cook the food, the usable food value can be increased or decreased.

18-3. Food. Survivors should be able to find something to eat wherever they are. One of the best places to find food is along the seacoast, between the high and low watermark. Other likely spots are the areas between the beach and a coral reef; the marshes, mud flats, or mangrove swamps where a river flows into the ocean or into a larger river; riverbanks, inland waterholes, shores of ponds and lakes, margins of forests, natural meadows,

FOOD	CALORIES	FAT
WHOLE LARGE DUCK EGG	177	12.0
SMALL OR LARGE MOUTH BASS - 3 TO 4 OZ.	109	3.6
CLAMS - 4 TO 5 LARGE	88	.2
FRESHWATER CRAYFISH - 3 TO 4 OZ.	75	.6
EEL - 3 TO 5 OZ.	240	20.0
OCTOPUS - 3 TO 4 OZ.	76	.9
ATLANTIC SALMON - 4 OZ.	220	14.0
RAINBOW TROUT - 4 OZ.	200	11.8
BANANA - ONE SMALL	87	.3
BREADFRUIT - 3 TO 4 OZ.	105	.5
GUAVA - ONE MEDIUM	64	.7
MANGO - ONE SMALL	68	.5
WILD DUCK - 4 OZ.	230	16.0
BAKED OPOSSUM - 4 OZ.	235	10.6
WILD RABBIT - 4 OZ.	124	4.0
VENISON - 4 OZ.	128	3.1
DANDELION GREENS - ONE CUP COOKED	70	1.4
POTATO - MEDIUM	78	.2
PRICKLY PEAR - 4 OZ.	43	.2

Figure 18-1. Food and Calorie Diagram.

protected mountain slopes, and abandoned cultivated fields.

a. Rations placed in survival kits have been developed especially to provide some of the proper sustenance needed during survival emergencies. When eaten as directed on the package, it will keep the survivor relatively efficient. If enough other food can be found, rations should be conserved for emergency use.

b. Consideration must be given to available food and water and how long the survival episode may last. Environmental conditions must also be considered. If a survivor is in a cold environment, more of the *proper* food will be required to provide necessary body heat. Rescue may vary from a few hours to several months, depending on the environment, operational commitments, and availability of rescue resources in that area. Available food must be rationed based on the estimated time which will elapse before being able to supplement issued rations with natural foods. If it is decided that some of the survivors should go for help, each traveler should be given twice as much food as those remaining behind. In this way, the survivors resting at the encampment and

those walking out will stay in about the same physical condition for about the same length of time.

c. If available water is less than a quart a day, avoid dry, starchy, and highly seasoned foods and meat. Keep in mind that eating increases thirst. For water conservation, the best foods to eat are those with high carbohydrate content, such as hard candy and fruit. All work requires additional food and water. When work is being performed, the survivor must increase food and water consumption to maintain physical efficiency. If food is available, it is alright to nibble throughout the day. It is preferable though to have at least two meals a day, with one being hot. Cooking usually makes food safer, more digestible, and palatable. The time spent cooking will provide a good rest period. On the other hand, some food such as saponilla, star apple, and soursop, are not palatable unless eaten raw.

d. Native foods may be more appetizing if they are eaten by themselves. Rations and native foods usually do not mix well. In many countries, vegetables are often contaminated by human feces which the natives use as fertilizer. Dysentery is transmitted in this way. If possible, survivors should try to select and prepare their own meals. If necessary to avoid offending the natives, indicate that religious beliefs or taboos require self-preparation of food.

e. Learn to overcome food prejudices. Foods that may not look good to the survivor are often a part of the natives regular diet. Wild foods are high in mineral and vitamin content. With a few exceptions, all animals are edible when freshly killed. Avoid strange looking fish and fish with flesh that remains indented when depressed as it is probably becoming spoiled and should not be eaten. With knowledge and the ability to overcome food prejudices, a survivor can eat and sustain life in strange or hostile environment.

18-4. Animal Food. Animal food gives the most food value per pound. Anything that creeps, crawls, swims, or flies is a possible source of food. People eat grasshoppers, hairless caterpillars, wood-boring beetle larvae and pupae, ant eggs, spider bodies, and termites. Such insects are high in fat and should be cooked until dried. Everyone has probably eaten insects contained in flour, cornmeal, rice, beans, fruits, and greens in their daily foods.

a. Man as a Predator. To become successful in hunting, the hunter must go through a behavioral change and reorganize personal priorities. This means the one and only goal for the present is to kill an animal to eat. To kill this animal, the hunter must mentally become a predator. The hunter must be prepared to undergo stress in order to hunt down and kill an animal. Because of the type of weapons survivors are likely to have, it will be necessary to get very close to the animal to immobilize or kill it. This is going to require all the stealth and cunning survivors can muster. In addition to

stealth and cunning, knowledge of the animal being hunted is very important. If in an unfamiliar area, survivors may learn much about the animal life of the area by studying signs such as trails, droppings, and bedding areas.

b. Animal Sign. The survivor should establish the general characteristics of the animals. The size of the tracks will give a good idea of the size of the animal. The depth of the tracks will indicate the weight of the animal. The animal dung can tell the hunter much. For example, if it is still warm or slimy, it was made very recently; if there is a large amount scattered around the area, it could well be a feeding or bedding area. The droppings may indicate what the animal feeds upon. Carnivores often have hair and bone in the dung; herbivores have coarse portions of the plants they have eaten. Many animals mark their territory by urinating or scraping areas on the ground or trees. These signs could indicate good trap or ambush sites. Following the signs (tracks, droppings, etc.) may reveal the feeding, watering, and resting areas. Well worn trails will often lead to the animal's watering place. Having made a careful study of all the signs of the animal, the hunter is in a much better position to procure it, whether electing to stalk, trap, or snare it, or lie in wait to shoot it.

c. Hunting. If survivors elect to hunt, there are some basic techniques which will be helpful and improve chances of success. Wild animals rely entirely upon their senses for their preservation. These senses are smell, vision, and hearing. Humans have lost the keenness of some of their senses like smelling, hearing, etc. To overcome this disadvantage, they have the ability to reason. As an example, some animals have a fantastic sense of smell, but this can be overcome by approaching the quarry from a downwind direction. The best times to hunt are at dawn and dusk as animals are either leaving or returning to their bedding areas. Both diurnal and nocturnal animals are active at this time. There are five basic methods of hunting:

(1) Still or Stand. This is the best method for inexperienced hunters as it involves less skill. The main principle of this method is to wait in ambush along a well-used game trail, until the quarry approaches within killing range. Morning and evening are usually the best times to still hunt. Care should be taken not to disturb the area; always wait downwind. Patience and self-control are necessary to remain motionless for long periods of time.

(2) Stalking. "Stalking" refers to the stealthily approach toward game. This method is normally used when an animal has been sighted and the hunter then proceeds to close the distance using all available cover. Stalking must be done slowly so that minimum noise is made; quick movement is easily detected by the animal. Always approach from the downwind side and move when the animal's head is down eating, drinking, or looking in another direction. The same techniques are

used in blind stalking as in the regular stalk, the main difference being that the hunter is stalking a position where the animal is expected to be while the animal is not in sight.

(3) Tracking. Tracking is very difficult unless conditions are ideal. This method involves reading all of the signs left behind by the animal, interpreting what the animal is doing, and how it can best be killed. The most common signs are trails, beds, urine, droppings, blood, tracks, and feeding signs.

(4) Driving. Some wild animals can be scared or driven in a direction where other hunters or traps have been set. This method is normally used where the game can be funneled; a valley or canyon is a good place to make a drive. More than one person is usually necessary to make a drive.

(5) Calling. Small predators may be called in by imitating an injured animal. Ducks and geese can be attracted by imitating their feeding calls. These noises can be made by sucking on the hand, blowing on a blade of grass or paper, sucking the lip, or using specially designed devices. Survivors should not call animals unless they know what they are doing as strange noises may "spook" the animal.

d. Killing Implements. It is difficult to kill animals of any size without using some type of tool or weapon. As our technology has increased in complexity, so have our killing tools. If a firearm is available, a basic knowledge of shooting and hunting techniques is necessary.

(1) Learning to become proficient with primitive weapons is important. Many primitive tribes of the world are still effectively using spears, clubs, bows and arrows, sling shots, etc., to provide food for their families. One of the limiting factors in the use of firearms is the amount of ammunition on hand. Therefore, a survivor cannot afford to waste ammunition on moving game or game which is beyond the effective range of the firearm being used. Wait for a pause in the animal's motions. The shot must be placed in a vital area with any firearm. Aim for the brain, spine, lungs, or heart (figure 18-2). A hit in these areas is usually fatal.

(2) A full-jacketed bullet often won't immediately down a larger animal hit in a vital area such as the lungs or heart. The alternative to losing the animal is tracking it to where it falls. Often it's better to wait awhile before pursuing the animal. If not pursued, it may lay down and stiffen or perhaps bleed to death. Follow the blood trail to where the game has gone down and kill it if it is

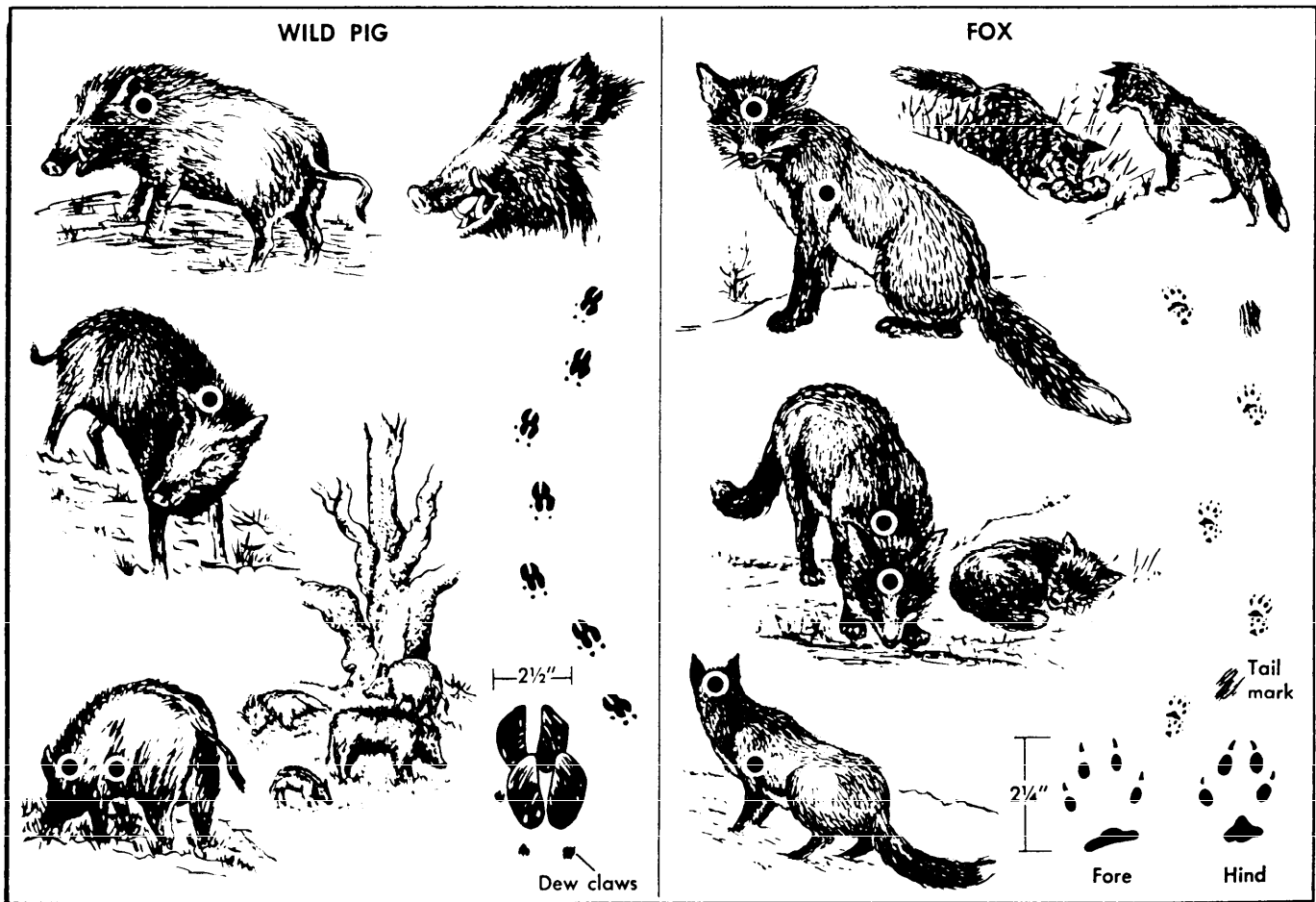

Figure 18-2. Shooting Game.

still alive. Even though ammunition might be limited, small game may be more productive than large game. Although they present smaller targets and have less meat, they are less wary, more numerous, and travel less distance to escape if wounded. A large amount of edible meat on small game can be destroyed from a bullet wound. On rodents, most of the meat is on the hind-quarters and frontquarters; birds, it is the breast and legs. The survivor should try to hit a vital spot that spoils the least meat.

(3) Night hunting is usually best, since most animals move at night. A flashlight or torch may be used to shine in the animal's eyes. It will be partly blinded by the light and a survivor can get much closer than in the daytime. If no gun is available, the animal can be killed with a club or a sharpened stick used as a spear.

(4) Remember that large animals, when wounded, cornered, or with their young, can be dangerous. Be sure the animal is dead, not just wounded, unconscious, or playing "possum." Animals usually die with their eyes open and glazed-over. Poke all "dead" animals in the eye with a long sharp stick before approaching them.

(5) Small freshwater turtles can often be found sunning themselves along rivers and lakeshores. If they dash into shallow water, they can still be procured with nets, clubs etc; watch out for mouth and claws. Frogs and snakes also sun and feed along streams. Use both hands to catch a frog—one to attract it and keep it busy while grabbing it with the other. Bright cloth on a fishhook also works. All snakes are good eating and can be killed with a long stick. Both marine and dry-land lizards are edible. A noose, small fishhook baited with a bright cloth lure, slingshot, or club can be used. A slingshot can be made with a forked stick and the elastic from the parachute pack or surgical tubing found in some survival kits (figure 18-3). With practice, the slingshot can be very effective for killing small animals.

e. Snaring and Trapping. Snaring and trapping animals are ways survivors can procure animal food to supplement issued rations. Since small animals are usually more abundant than large animals, they will probably be the survivor's main source of food. Snares should

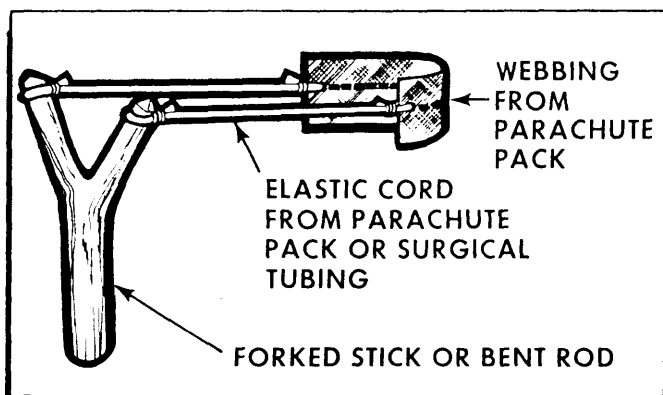

Figure 18-3. Slingshot.

be set out on a 15:1 ratio; 15 snares should be set out for every one animal expected to be caught.

(1) Using traps and snares are more advantageous than going out on foot and physically hunting the animal. The most important advantage being that traps work 24 hours a day with no assistance from the hunter. A large area can be effectively trapped with the possibility of catching many animals within the same period of time. Survivors (generally) use much less energy maintaining a trapline than is used by hunting. This means less food is required because less energy is expended.

(2) The traps or snares should be set in areas where the game is known to live or travel. Look for signs such as tracks, droppings, feeding signs, or actual sightings of the animal. If snares are used, they should be set up to catch the animal around the neck. Therefore, the loop must allow the head to pass through but not the body. Loops will vary in size from one animal to another. When placing snares, try to find a narrow area of the game trail where the animal has no choice but to enter the loop. If a narrow area cannot be found, brush or other obstacles can be arranged to funnel the animal into the snare (figure 18-4). Do not overdo the funneling; use as little as possible. Avoid disturbing the natural surroundings if possible. Do not walk on game trails, but approach 90 degrees to the trail, set the snare, and back away. Snares may also be set over holes or burrows. All snares and traps should be set during the midday because most animals are nocturnal in nature. Check snares and traps twice daily. If possible, check after sunup and before sunset. The checks should be made from a distance so any animals moving at the time of checking will not be disturbed or frightened away.

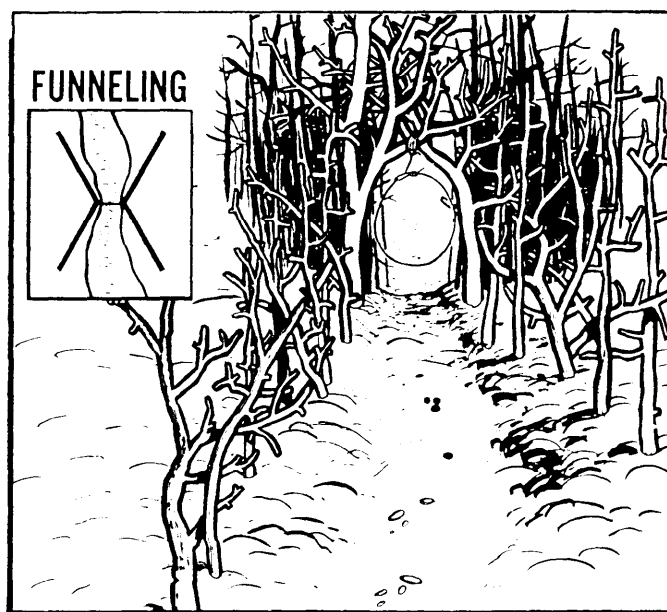

Figure 18-4. Funneling.

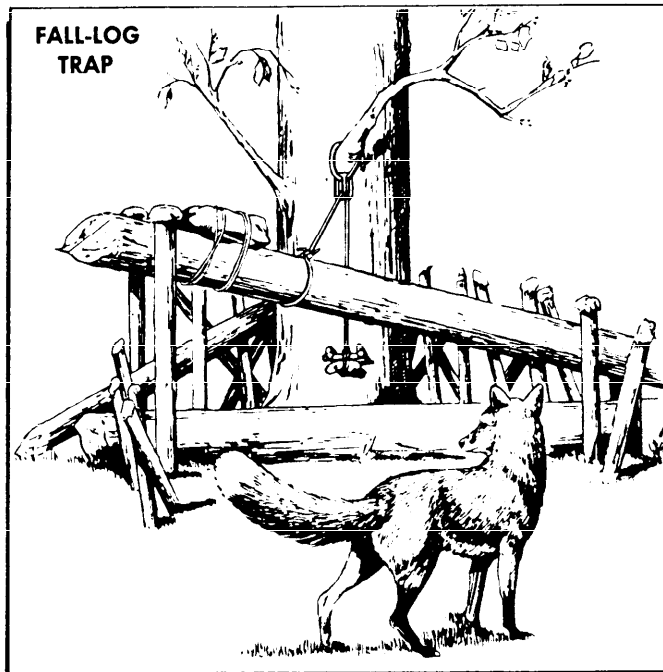

Figure 18-5. Mangle.

(3) There are three ways to immobilize or trap animals.

(a) Strangle. This is done by simply using a free-sliding noose which, when tightened around the neck, will restrict circulation of air and blood. The materials should be strong enough to hold the animal; for example, suspension line, string, wire, cable, or rawhide.

(b) Mangle. Mangle traps use a weight which is suspended over the animal's trail or over bait. When the animal trips the trigger, the weight (log) will descend and mangle the animal (figure 18-5).

(c) Hold. Any means of impeding the animal and detaining its progress would be considered a hold-type trap.

(4) The apache foot snare is an example of a hold-type trap. It is used for large browsers and grazers like deer (figure 18-6). It should be located along game trails where an obstruction, such as a log, blocks the trail. When animals jump over this obstruction, a very shallow depression is formed where their hooves land. The apache foot snare should be placed at this depression. The box trap for birds is another example of hold-type traps (figure 18-7).

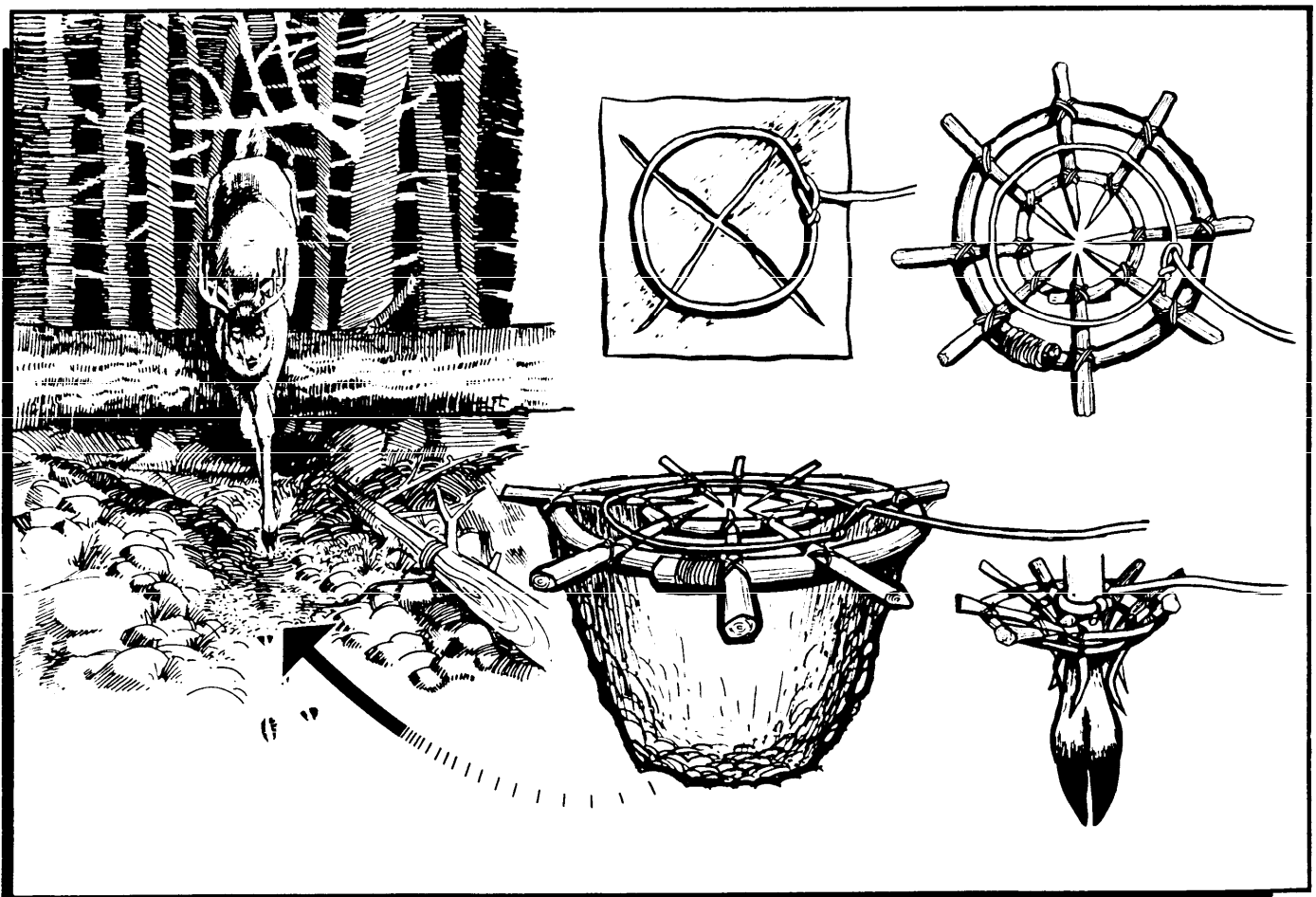

Figure 18-6. Apache Foot Snare.

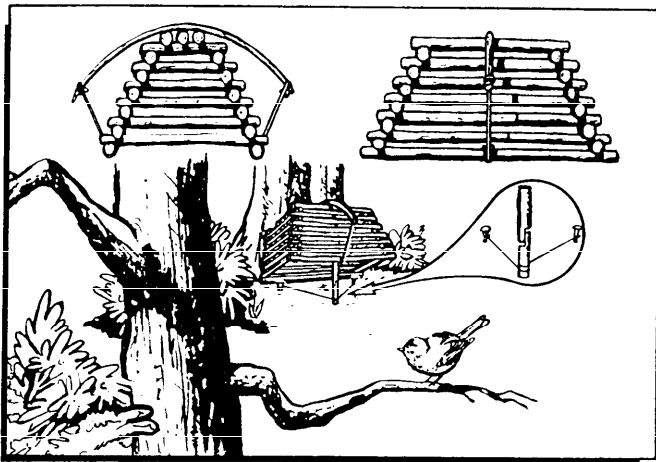

Figure 18-7. Box Trap.

(5) The simple loop is the quickest snare to construct. All snares and traps should be simple in construction with as few moving parts as possible. This loop can be constructed from any type of bare wire, suspension line, inner core, vines, long strips of green bark, clothing strips or belt, and any other material that will not break under the strain of holding the animal. If wire is being used for snares, a figure "8" or locking loop should be used (figure 18-8). Once tightened around the animal, the wire is locked into place by the figure "8" which prevents the loop from opening again. A simple loop snare is generally placed in the opening of a den, with the end of the snare anchored to a stake or similar object (figure 18-8). The simple loop snare can also be used when making a squirrel pole (figure 18-9) or with some types of trigger devices.

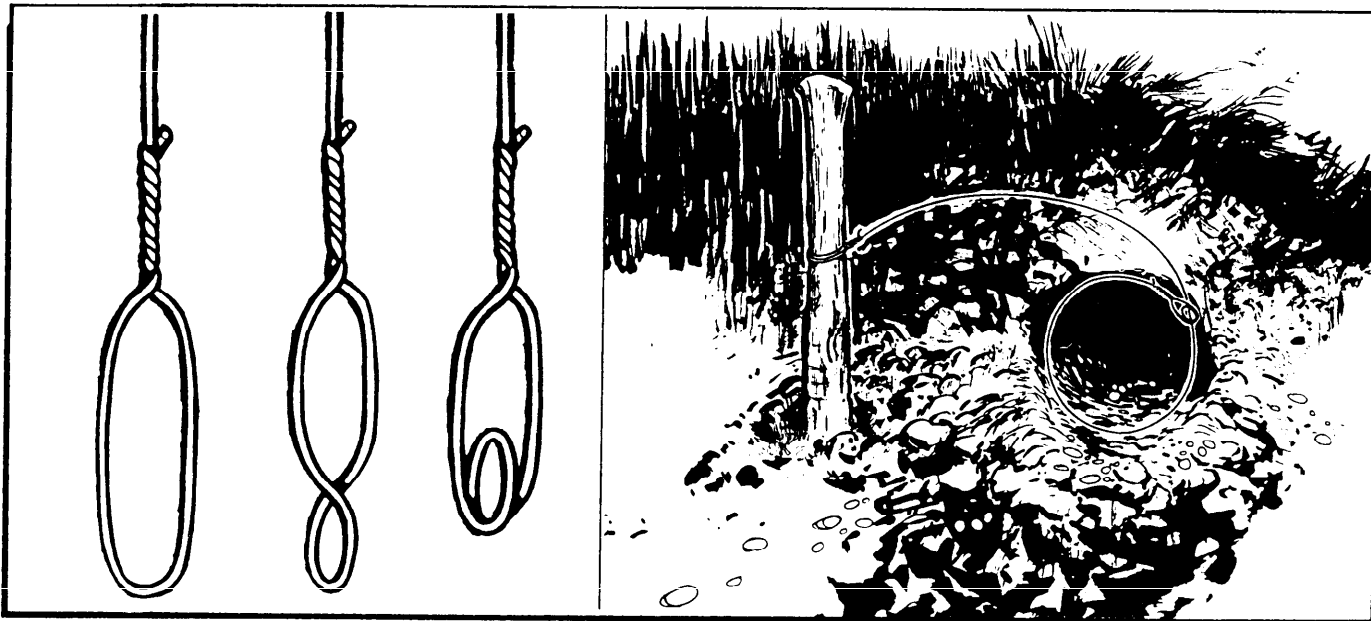

Figure 18-8. Locking Loop and Setting Noose.

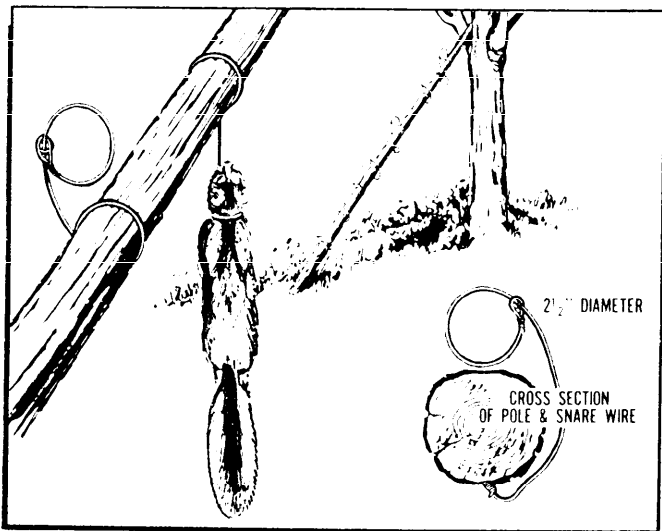

Figure 18-9. Squirrel Pole.

f. Triggers. Triggers may be used with traps. The purpose of the trigger is to set the device in motion, which will eventually strangle, mangle, or hold the animal. There are many triggers. Some of the more common ones are:

- (1) Two-pin toggle with a counterweight for small to medium animals which are lifted out of the reach of predators (figure 18-10).
- (2) Figure "H" with wire snare for small mammals and rodents (figure 18-11).
- (3) Canadian ace for predators such as bobcat, coyote, etc., (figure 18-12).
- (4) Three-pin toggle with deadfall for medium to large animals (figure 18-13). Medium and large animals can be captured using deadfalls, but this type of trap is recommended only when big game exists in large quantities to justify the great expense of time and effort spent in constructing the trap.

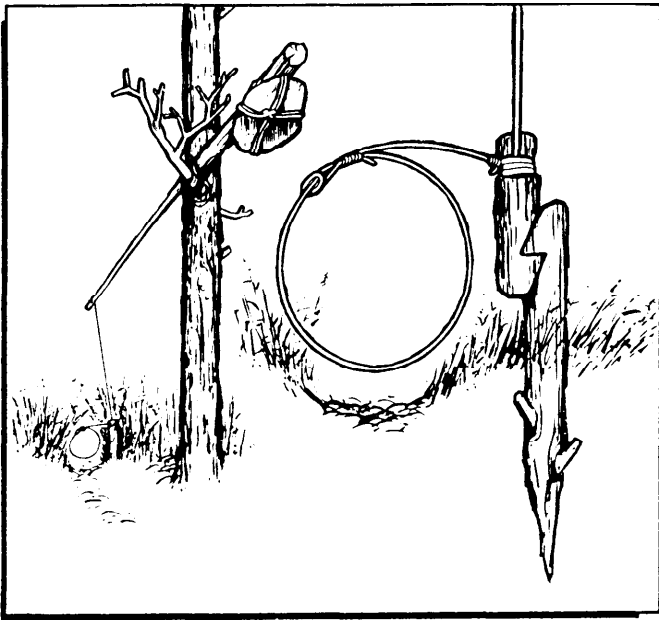

Figure 18-10. Two-Pin Toggle.

(5) The twitch-up snare which incorporates the simple loop, can be used to catch small animals (figure 18-14). When the animal is caught, the sapling jerks it up into the air and keeps the carcass out of the reach of predators. This type of snare will not work well in cold climates, since the bent sapling will freeze in position and not spring up when released.

(6) A long forked stick can be used as a twist stick to procure ground squirrels, rabbits, etc. A den that has signs of activity must be located. Using the long forked stick, the survivor probes the hole with the forked end until something soft is felt then twisting the stick will entangle the animal's hide in the stick and the animal can be extracted (figure 18-18).

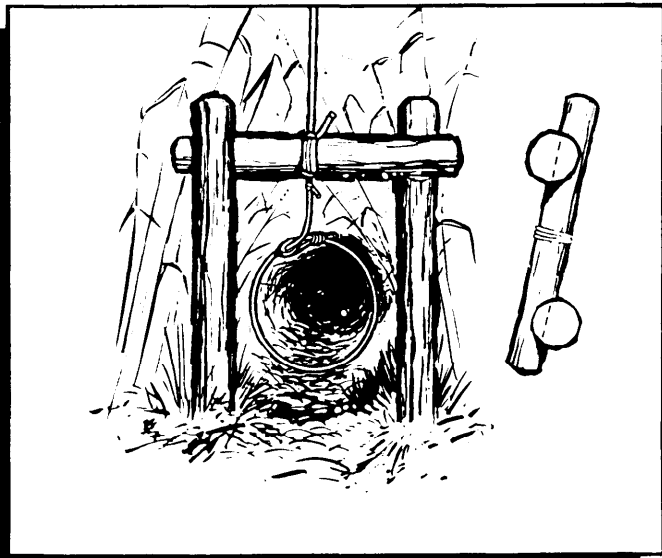

Figure 18-11. Figure H.

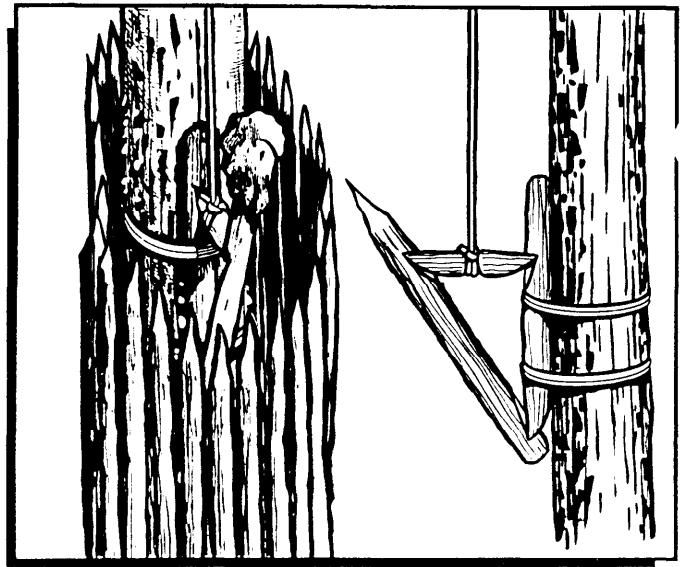

Figure 18-12. Canadian Ace.

g. Birds. Birds can be caught with a gill net. The net should be set up at night vertically to the ground in some natural flyway, such as an opening in dense foliage. A small gill net on a wooden frame with a disjointed stick for a trigger can also be used. A gill net can be made by using inner core from parachute suspension line (figure 18-20).

(1) Birds can be caught on baited fishhooks (figure 18-15) or simple slipping loop snares. Bird's nest can be a source of food. All bird eggs are edible when fresh. Large wading birds such as cranes and herons often nest in mangrove swamps or in high trees near water.

(2) During molting season, birds cannot fly because of the loss of their "flight" feathers; they can be procured by clubbing or netting.



Figure 18-13. Three-Pin Toggle.

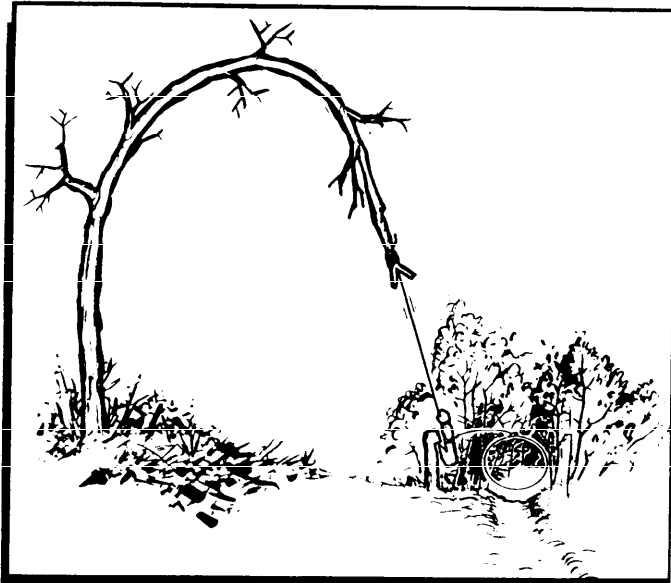

Figure 18-14. Twitch Up.

(3) Birds can be also caught in an Ojibway snare. This snare is made by cutting a 1- or 2-inch thick sapling at a height of 4½ to 5 feet above the ground (figure 18-16). A springy branch is then whittled flat at the butt end and a rectangular hole is cut through the flattened end. One end of a ½-inch thick stick, 15 inches long, is then whittled to fit slightly loose in the hole and the top corner of the whittled end is rounded off so the stick will easily drop away from the hole. The branch is then tied by its butt end to the top of the sapling. A length of inner core from suspension line is tied to the bottom end of the branch and the branch is bent into a bow with the line passing through the hole in the butt end. A knot is tied in the line and the 15-inch stick is then placed in the hole to lock the line in place (just behind the knot). An 8-inch loop is made at the end of the line

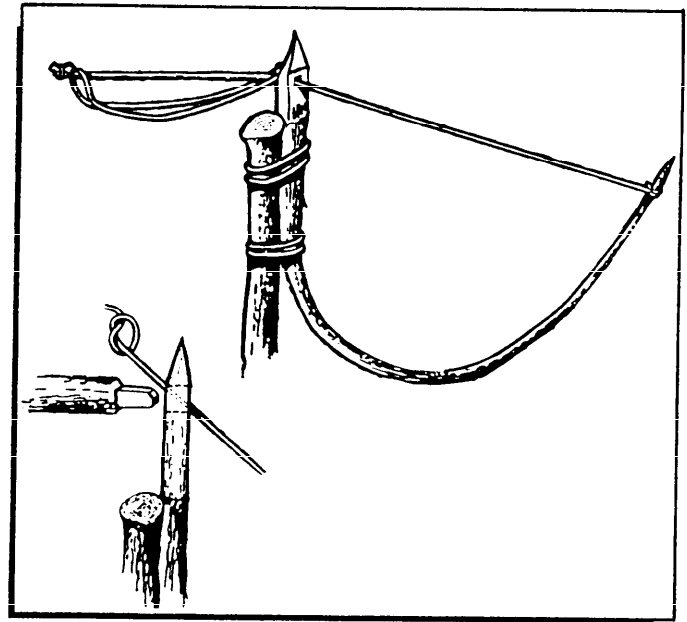

Figure 18-16. Ojibwa Bird Snare.

and laid out on the 15-inch stick (spread out as well as possible). A piece of bait is placed on top of the sapling, and when a bird comes to settle on the 15-inch stick, the stick drops from the hole causing the loop to tighten around the bird's legs.

(4) When many birds frequent a particular type of bush, some simple loop snares may be set up throughout the bush. Make the snares as large as necessary for the particular type of birds that come to perch, feed, or roost there (figure 18-17).

(5) In wild, wooded areas, many larger species of birds such as spruce grouse and ptarmigan may be approached. The spruce grouse, which has merited the name of "fools hen," can be approached and killed with

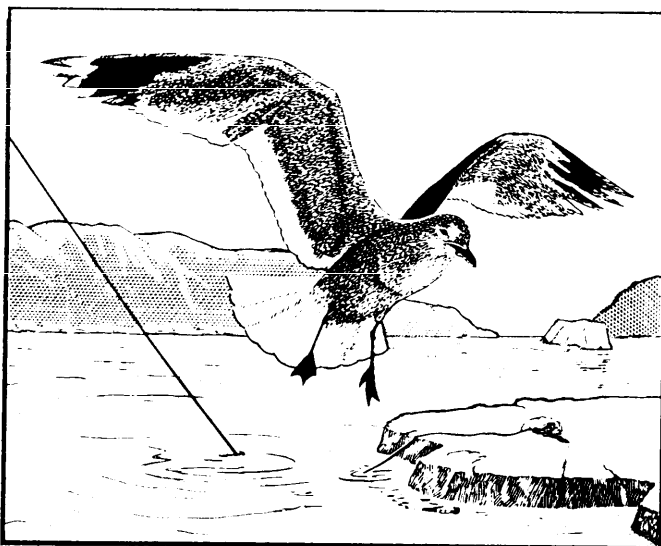

Figure 18-15. Baited Fishhook.

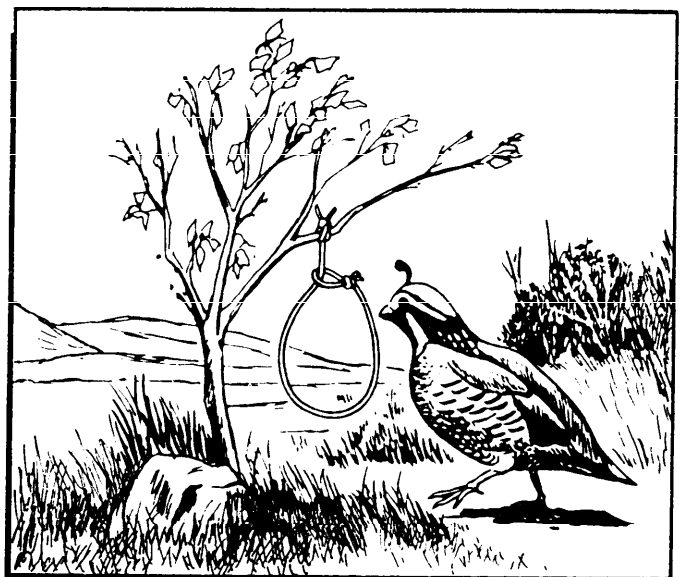

Figure 18-17. Ptarmigan or Small Game Snare.

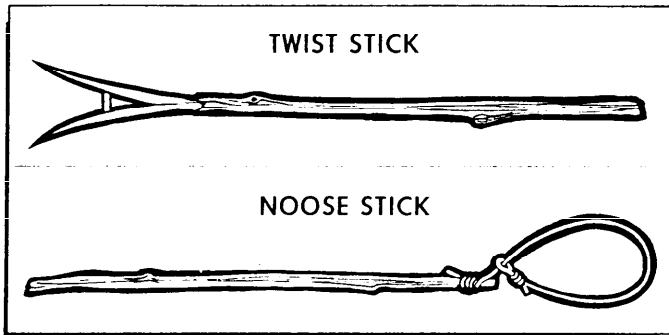

Figure 18-18. Twist Stick and Noose Stick.

a stick with little trouble. It often sits on the lower branches of trees and can be easily caught with a long stick with a loop at the end (figure 18-18).

(6) Ground feeding birds (Quail, Hungarian Partridge, Chukar) can be trapped in a trench dug into the ground. The trench should be just wide enough for the bird to walk into, so survivors must first observe the

type of ground feeding birds in the area. The trench should be 2 to 3 feet long and about 10 to 12 inches deep at the deep end. The other end of the trench should be ramped down from the surface level. Bait is scattered along the surface into the pit, and after having pecked the last piece of bait the bird will not be able to get out of the pit because it can't fly out or climb out, its feathers keep it from backing out, and it can't turn around to walk out.

(7) Perching birds may be captured by using bird lime. Bird lime is a term applied to any sticky or gluey substance which is rubbed on a branch to prevent the flight of a bird which has landed on it or has flapped a wing against it. Bird lime is usually made from the sap of plants in the Euphorbia family. The common names of some of these plants are spotted spurge, cypress spurge, snow-on-the-mountain, and poinsettias. The Euphorbias have a wide range in North and Central America. The milky sap is poisonous and may cause blisters on the skin and should be handled with care. Bird lime is most effective in the desert and jungle, but

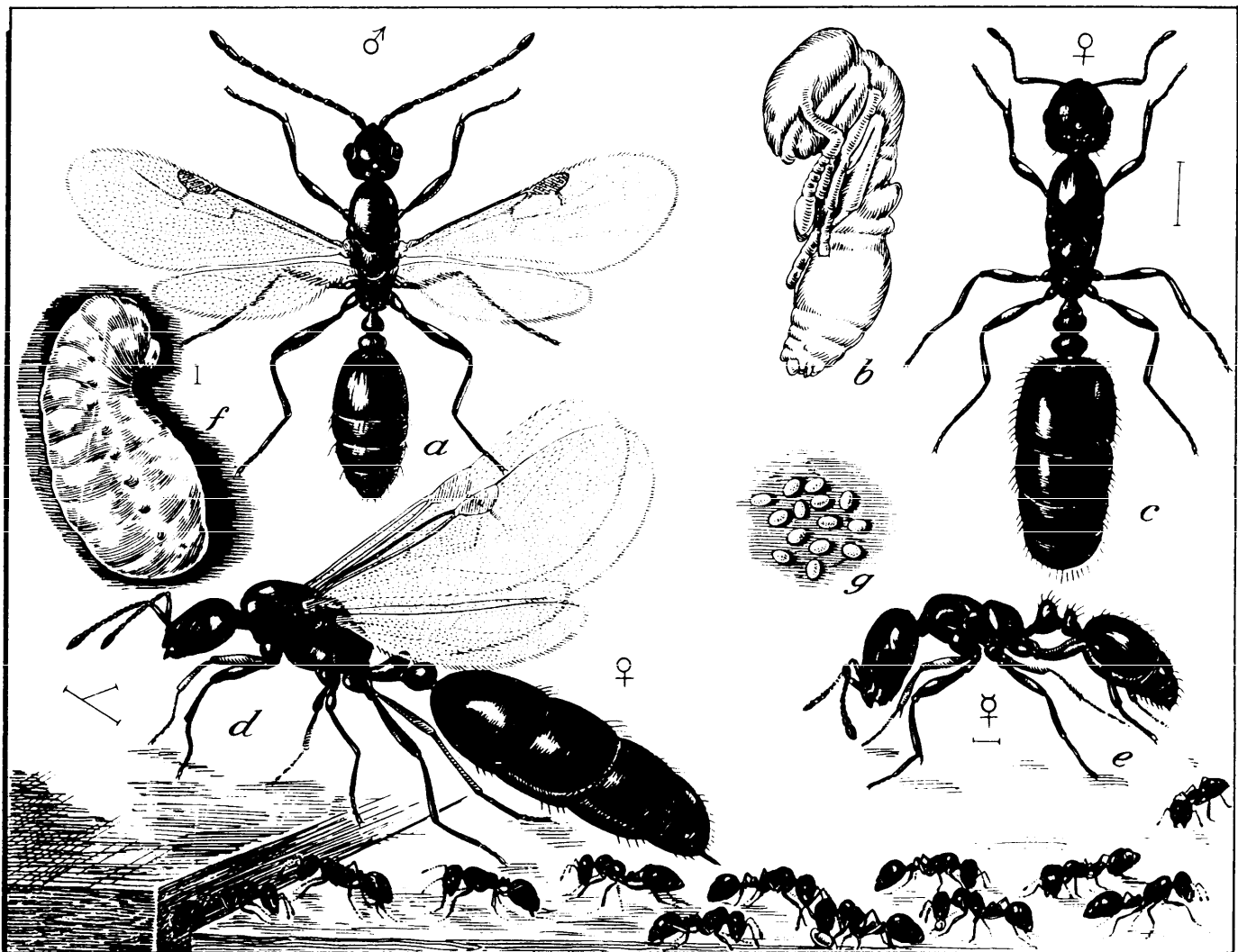

Figure 18-19. Ants.

it will not work in cold weather. Dust will make bird lime ineffective, so it should be used in spots where dust is not prevalent. The sap of the breadfruit tree makes excellent bird lime as it swells and become glutinous upon contact with air.

h. Insects. If there *ever* is a time when food aversions must be overcome, it is when survivors turn to insects as a food source.

(1) Primitive peoples eat insects and consider them great delicacies. When food is limited and insects are available, they can become a valuable food source. In some places, locusts and grasshoppers, cicadas, and crickets are eaten regularly; occasionally termites, ants, and a few species of stonefly larvae are consumed. Big beetles such as the Goliath Beetle of Africa, the Giant Water Beetles, and the big Long Horns are relished the world over. Clusters, like those of the Snipefly *Atherix* (that overhang the water), and the windrows of Brinefly puparia are eaten. Aquatic water bugs of Mexico are grown especially for food. All stages of growth can be eaten, including the eggs but, the large insects must be cooked to kill internal parasites.

(2) Termites and white ants are also an important food source. Strangely enough, these are closely related to cockroaches. The reason they are eaten so extensively in Africa is the fact that they occur in enormous numbers and are easily collected both from their nests and during flight. They are sometimes attracted to light in unbelievable numbers and the natives become greatly excited when the large species appear.

(3) Many American Indian tribes made a habit of eating the large carpenter ants that are sometimes pests in houses. These were eaten both raw and cooked. Even today the practice of eating them has not entirely disappeared, although they do not form an essential part of the diet of any of the inhabitants of this country (figure 18-19).

(4) It is not at all unnatural that the American Indians should have relished the honey ants in all parts of the continent where they occur. These ants are peculiar in that some of the workers become veritable storehouses for honey, their abdomens becoming more or less spherical and so greatly enlarged that they are scarcely able to move. They cluster on the ceilings and walls of their nests and disgorge part of their stored food to other inhabitants. The Indians discovered the sweetness stored in these insects and made full use of it. At first they ate the ants alive, later gathering them in quantity and crushing them so that they formed an enticing dish—one which was considered a delicacy and served to guests of distinction as a special favor. The next step in the use of the honey ant was the extraction of the pure honey by crushing the insects and straining the juices. After the honey was extracted, it was allowed to ferment, forming what is said to be a highly flavored wine.

(5) Indians of the American tropics, with a much larger ant fauna from which to choose, select the queens

of the famous leafcutting or so-called umbrella ants upon which to feed, eating only the abdomens, either raw or cooked.

(6) It is natural that caterpillars, the larvae of moths and butterflies, should form a very substantial part of the food of primitive peoples because these are often of large size or occur in great abundance. In Africa, many tribes consider caterpillars choice morsels of food, and much time is spent in collecting them. Some of the native tribes recognize 20 or more different kinds of caterpillars that are edible, and are sufficiently well acquainted with the life history of the insects to know the plants upon which they feed and the time of year when they have reached the proper stage of development for collecting. Caterpillars with hairs should be avoided. If eaten, the hairs may become lodged in the throat causing irritation or infection. Today it is known that insects have nutritional or medicinal value. The praying mantis, for example, contains 58 percent protein, 12 percent fat, 3 percent ash, vitamin B complex, and vitamin A. The insect's outer skeleton is an interesting compound of sugar and amino acids.

(7) Bee larvae were eaten by the ancient Chinese. Some Chinese today eat locusts, dragonflies, and bumblebees. Cockroaches and locusts are a favorite dish in Szechuan. In Kwangtun, grasshoppers, golden June beetles, crickets, wasp larvae, and silkworm larvae are used for food.

(8) Stinging insects should have their stinging apparatus removed before they are eaten.

(9) As can be seen, insects have been used as a food source for thousands of years and will undoubtedly continue to be used. If survivors cannot overcome their aversion to insects as a food source, they will miss out on a valuable and plentiful supply of food.

i. Fishing. Fishing is one way to get food throughout the year wherever water is found. There are many ways to catch fish which include hook and line, gill nets, poisons, traps, and spearing.

(1) If an emergency fishing kit is available, there will be a hook and line in it, but if a kit is not available a hook and line will have to be procured elsewhere or improvised. Hooks can be made from wire or carved from bone or wood. The line can be made by unraveling parachute suspension line or by twisting threads from clothing or plant fibers. A piece of wire between the fishing line and the hook will help prevent the fish from biting through the line. Insects, smaller fish, shellfish, worms, or meat can be used as bait. Bait can be selected by observing what the fish are eating. Artificial lures can be made from pieces of brightly colored cloth, feathers, or bits of bright metal or foil tied to a hook. If the fish will not take the bait, try to snag or hook them in any part of the body as they swim by. In freshwater, the deepest water is usually the best place to fish. In shallow streams, the best places are pools below falls, at the foot of rapids, or behind rocks. The best time to fish is usual-



Figure 18-20. Fishing Places.

ly early morning or late evening (figure 18-20). Sometimes fishing is best at night, especially in moonlight or if a light is available to attract the fish. The survivor should be patient and fish at different depths in all kinds of water. Fishing at different times of the day and changing bait often is rewarding.

(2) The most effective fishing method is a net because it will catch fish without having to be attended (figures 18-21 and 18-22). If a gill net is used, stones can be used for anchors and wood for floats. The net should be set at a slight angle to the current to clear itself of any floating refuse that comes down the stream. The net should be checked at least twice daily (figure 18-23). A net with poles attached to each end works effectively if moved up or down a stream as rapidly as possible while moving stones and threshing the bottom or edges of the streambanks. The net should be checked every few moments so the fish cannot escape.

(3) Shrimp (prawns) live on or near the sea bottom and may be scraped up. They may be lured to the surface with light at night. A hand net made from parachute cloth or other material is excellent for catching shrimp. Lobsters are creeping crustaceans found on or near the sea bottom. A lobster trap, jig, baited hook, or dip net can be used to catch lobster. Crabs will creep, climb, and burrow and are easily caught in shallow

water with a dip net or in traps baited with fish heads or animal viscera.

(4) Fishtraps (figure 18-24) are very useful for catching both freshwater and saltwater fish, especially those that move in schools. In lakes or large streams, fish tend to approach the banks and shallows in the morning and evening. Sea fish, traveling in large schools, regularly approach the shore with the incoming tide, often moving parallel to the shore guided by obstruction in the water.

(a) A fishtrap is basically an enclosure with a blind opening where two fence-like walls extend out, like a funnel, from the entrance. The time and effort put into building a fishtrap should depend on the need for food and the length of time survivors plan to stay in one spot.

(b) The trap location should be selected at high tide and the trap built at low tide. One to 2 hours of work should do the job. Consider the location, and try to adapt natural features to reduce the labors. Natural rock pools should be used on rock shores. Natural pools on the surface of reefs should be used on coral islands by blocking the opening as the tide recedes. Sandbars, and the ditches they enclose, can be used on sandy shores. The best fishing off sandy beaches is the lee side of offshore sandbars. By watching the swimming habits

of fish, a simple dam can be built which extends out into the water forming an angle with the shore. This will trap fish as they swim in their natural path. When planning a more complex brush dam, select protected bays or inlets using the narrowest area and extending one arm almost to the shore.

(c) In small, shallow streams, the fishtraps can be made with stakes or brush set into the stream bottom or weighted down with stones so that the stream is blocked except for a small narrow opening into a stone or brush pen or shallow water. Wade into the stream, herding the fish into the trap, and catch or club them when they get in shallow water. Mud-bottom streams can be trampled until cloudy and then netted. The fish are blinded and cannot avoid the nets. Freshwater crawfish and snails can be found under rocks, logs, overhanging bushes, or in mud bottoms.

(5) Fish may be confined in properly built enclosures and kept for days. In many cases, it may be advan-

tageous to keep them alive until needed and thus ensure there is a fresh supply without danger of spoilage. Mangrove swamps are often good fishing grounds. At low tide, clusters of oysters and mussels are exposed on the mangrove "knees" or lower branches. Clams can be found in the mud at the base of trees. Crabs are very active among branches or roots and in the mud. Fish can be caught at high tide. Snails are found on mud and clinging to roots. Shellfish which are not covered at high tide or those from a colony containing diseased members should not be eaten. Some indications of diseased shellfish are shells gaping open at low tide, foul odor, and (or) milky juice.

(6) Throughout the warm regions of the world, there are various plants which the natives use for poisoning fish. The active poison in these plants is harmful only to cold-blooded animals. Survivors can eat fish killed by this poison without ill effects.

(a) In Southeast Asia, the derris plant is widely

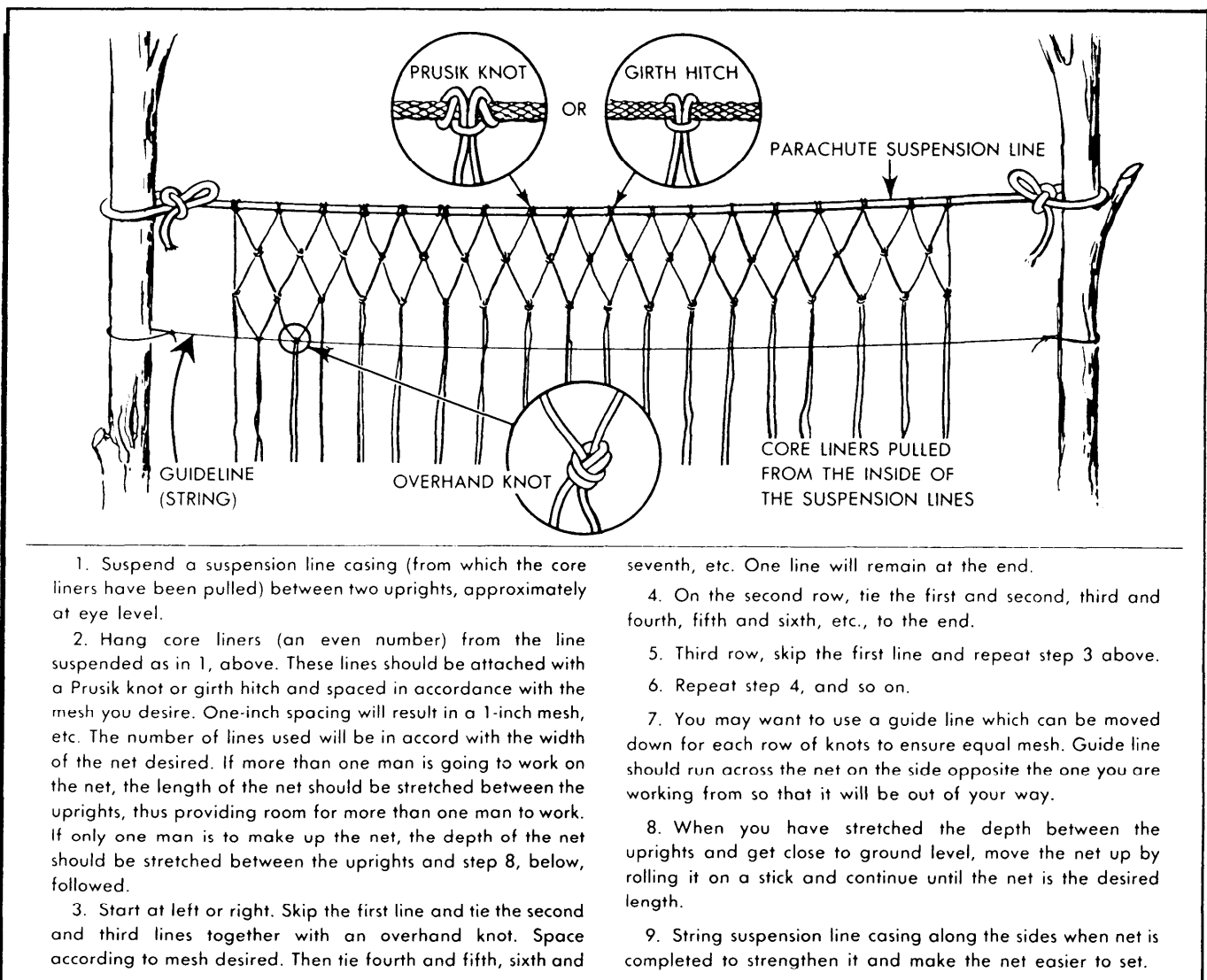
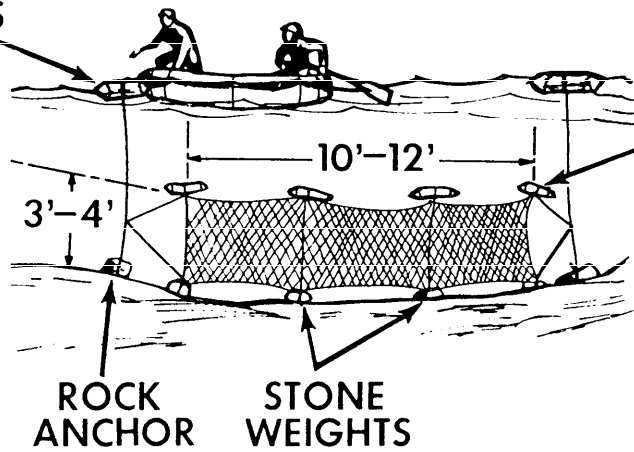
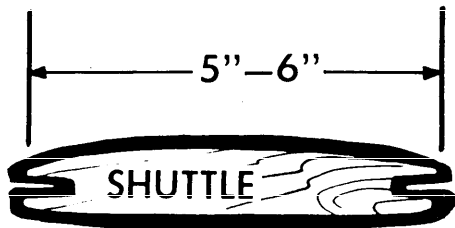

Figure 18-21. Making a Gill Net.

THE GILL NET

LARGE WOOD FLOATS



WIDTH CONTROLS SIZE OF MESH; MESH SIZE WILL BE DOUBLE THE WIDTH OF SPACER. MAKE OF THIN STIFF MATERIAL.

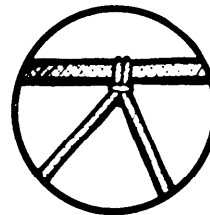
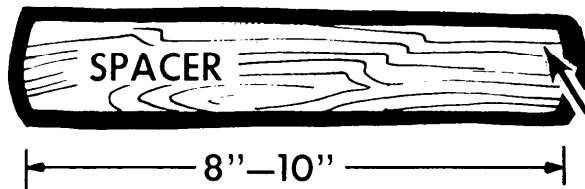

BEGIN WEAVING ON STICK. TAUTLY STRETCHED SUSPENSION LINE OR ROPE. TIE FIRST LINE OF MESH AS SHOWN, USING SPACER.

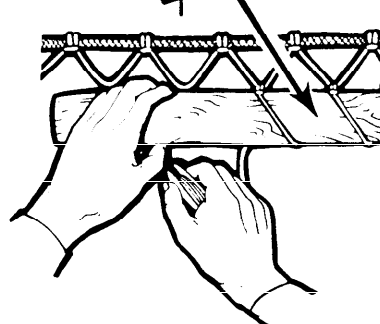

TOP OF SPACER SHOULD BE TIGHT AGAINST APEX OF UPPER ROW.

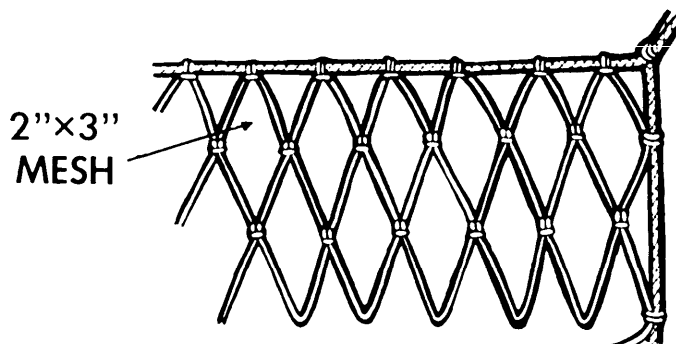
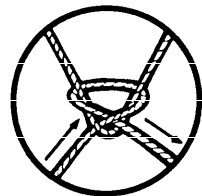
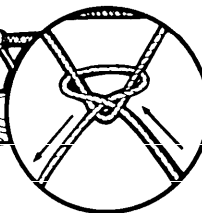

WEAVE AS SHOWN. PULL KNOTS TIGHT. WEAVE EACH ROW, USING PROPER KNOTS FOR LEFT AND RIGHT ROWS. WEAVE BACK AND FORTH UNTIL DESIRED LENGTH IS COMPLETED.

FINISH NET EDGES BY BINDING TO SUSPENSION LINE.

Figure 18-22. Making a Gill Net With Shuttle and Spacer.

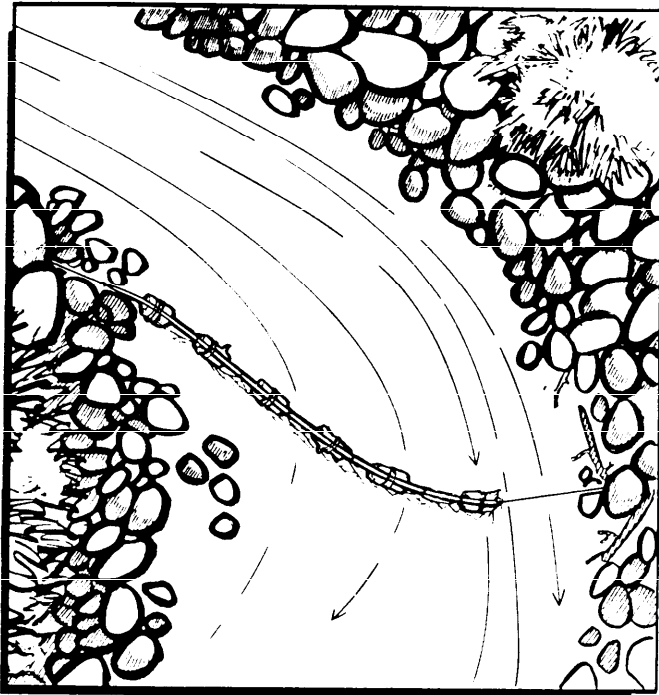

Figure 18-23. Setting the Gill Net.

used as a source of fish poison. The derris plant, a large woody vine, is also used to produce a commercial fish poison called rotenone. Commercial rotenone can be used in the same manner as crushed derris roots; it causes respiratory failure in fish, but has no ill effects on humans. However, rotenone has no effect if dusted over the surface of a pond. It should be mixed to a malted-milk consistency with a little water, and then distributed in the water. If the concentration is strong, it takes effect within 2 minutes in warm water, or it may take an hour in colder water. Fish sick enough to turn over on their backs will eventually die. An ounce of 12 percent rotenone can kill every fish for a half mile down a slow-moving stream that is about 25 feet wide. A few facts to remember about the use of rotenone are:

- 1. It is very swift acting in warm water at 70°F and above.
- 2. It works more slowly in cold water and is not practical in water below 55°F.
- 3. It is best applied in small ponds, streams, or tidal pools.
- 4. Excess usage will be wasted. However, too little will not be effective.

(b) A small container of 12 percent rotenone (one-half ounce) is a valuable addition to any emergen-

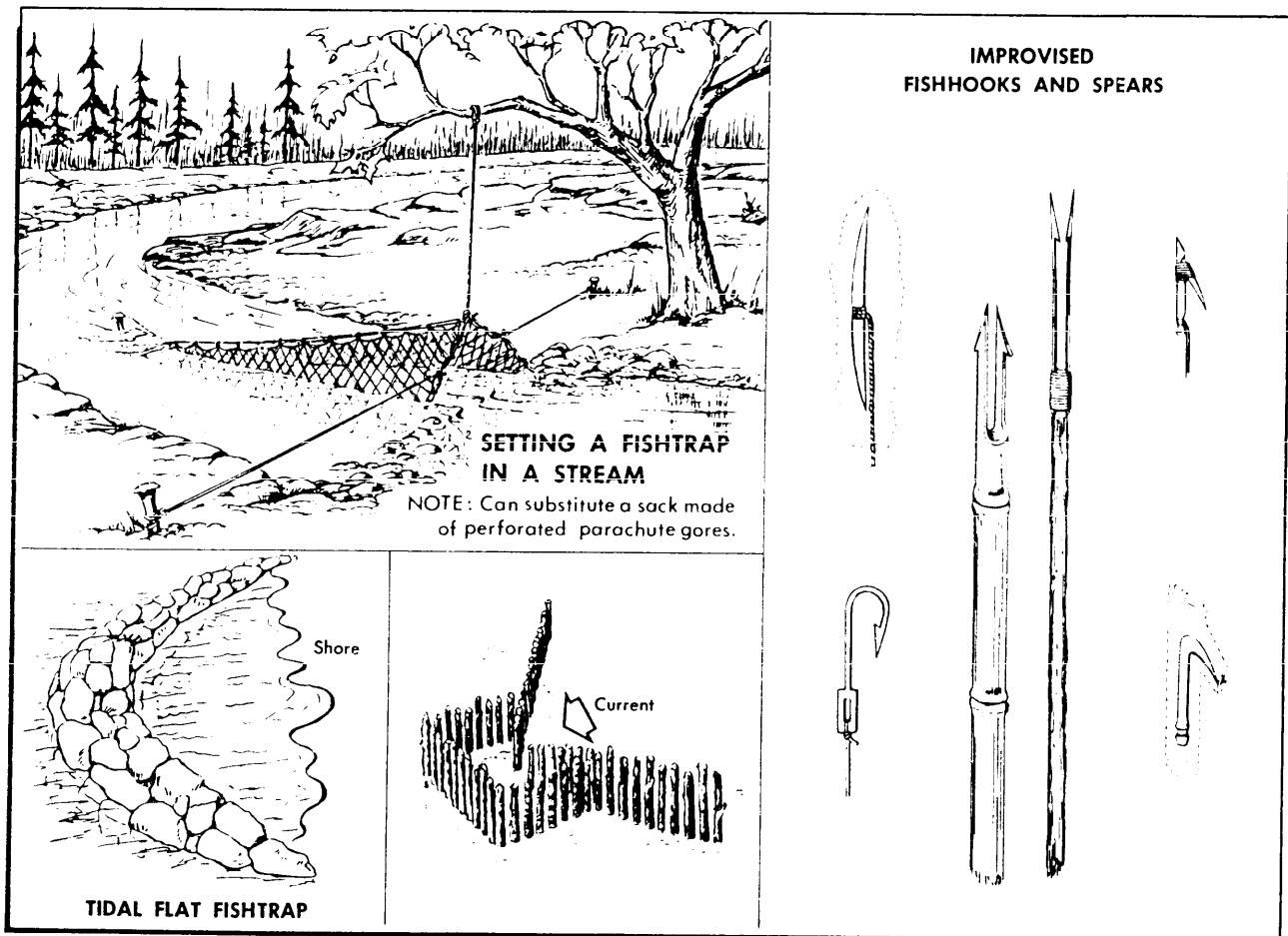

Figure 18-24. Maze-type Fishtraps.

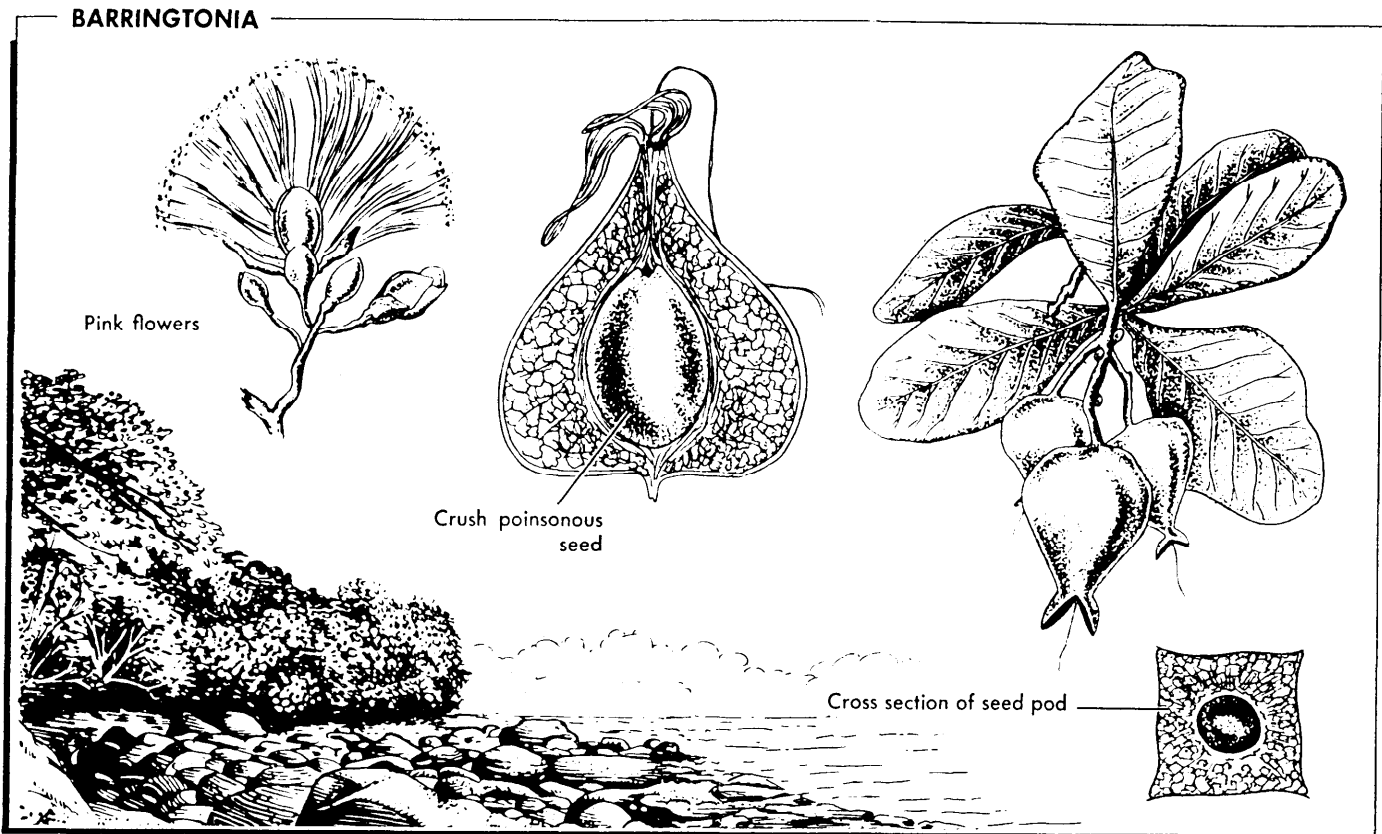

Figure 18-25. Barringtonia Plant for Poisoning Fish.

cy kit. Do not expose it unnecessarily to air or light; it retains its toxicity best if kept in a dark-colored vial. Lime thrown in a small pond or tidal pool will kill fish in the pool. Lime can be obtained by burning coral and seashells.

(c) The most common method of using fish-poison plants is to crush the plant parts (most often the roots) and mix them with water. Drop large quantities of the crushed plant into pools or the headwaters of small streams containing fish. Within a short time, the fish will rise in a helpless state to the surface. After putting in the poison, follow slowly down stream and pick up the fish as they come to the surface, sink to the bottom, or swim crazily to the bank. A stick dam or obstruction will aid in collecting fish as they float downstream. The husk of "green" black walnuts can be crushed and sprinkled into small sluggish streams and pools to act as a fish stupefying agent. In the southwest Pacific, the seeds and bark from the barringtonia tree (figure 18-25) are commonly used as a source of fish poison. The barringtonia tree usually grows along the seashore.

(7) Tickling can be effective in small streams with undercut banks or in shallow ponds left by receding flood waters. Place hands in the water and reach under the bank slowly, keeping the hands close to the bottom if possible. Move the fingers slightly until they make contact with a fish. Then work hands gently along its

belly until reaching its gills. Grasp the fish firmly just behind the gills and scoop it onto land. In the tropics, this type of fishing can be dangerous due to hazardous marine life in the water such as piranhas, eels, and snakes.

18-5. Plant Food. The thought of having a diet consisting only of plant food is often distressing to stranded aircrew members. This is not the case if the survival episode is entered into with the confidence and intelligence based on knowledge or experience. If the survivors know what to look for, can identify it, and know how to prepare it properly for eating, there is no reason why they can't find sustenance. In many isolated regions, survivors who have had some previous training in plant identification can enjoy wild plant food.

a. Plants provide carbohydrates, which provide body energy and calories. Carbohydrates keep weight and energy up, and include important starches and sugars.

b. A documented and authoritative example of the value of a strictly plant diet in survival can be cited in the case of a Chinese botanist who had been drafted into the Japanese Army during World War II. Isolated with his company in a remote section of the Philippines, the Chinese botanist kept 60 of his fellow soldiers alive for 16 months by finding wild plants and preparing them properly. He selected six men to assist him, and

then found 25 examples of edible plants in the vicinity of their camp. He acquainted the men with these samples, showing them what parts of the plants could be used for food. He then sent the men out to look for similar plants and had them separate the new plants according to the original examples to avoid any poisonous plant mingling with the edible ones. The result of this effort was impressive. Though all the men had a natural desire for ordinary food, none suffered physically from the plant food diet. The report was especially valuable because the botanist kept a careful record of all the food used, the results, and the comments of the men. This case history reflects the same opinions as those found in questionnaires directed to American survivors during World War II.

c. Another advantage of a plant diet is availability. In many instances, a situation may present itself in which procuring animal food is out of the question because of injury, being unarmed, being in enemy territory, exhaustion, or being in an area which lacks wildlife. If convinced that vegetation can be depended upon for daily food needs, the next question is "where to get what and how."

(1) Experts estimate there are about 300,000 classified plants growing on the surface of the Earth, including many which thrive on mountain tops and on the floors of the oceans. There are two considerations that survivors must keep in mind when procuring plant foods. The first consideration, of course, is the plant be edible, and preferably, palatable. Next, it must be fairly abundant in the areas in which it is found. If it includes an inedible or poisonous variety in its family, the edible plant must be distinguishable to the average eye from the poisonous one. Usually a plant is selected because one special part is edible, such as the stalk, the fruit, or the nut.

(2) To aid in determining plant edibility, there are general rules which should be observed and an edibility test that should be performed. In selecting plant foods, the following should be considered. Select plants resembling those cultivated by people. It is risky to rely upon a plant (or parts thereof) being edible for human consumption simply because animals have been seen eating it (for example, horses eat leaves from poison ivy; some rodents eat poisonous mushroom). Monkeys will put poisonous plants and fruits in pouches of their mouths and spit them out later. When selecting an unknown plant as a possible food source, apply the following general rules:

(a) Mushrooms and fungi should not be selected. Fungi have toxic peptides, a protein-base poison which has no taste. There is no field test other than eating to determine whether an unknown mushroom is edible. Anyone gathering wild mushrooms for eating must be absolutely certain of the identity of every specimen picked. Some species of wild mushrooms are difficult for an expert to identify. Because of the potential for

poisoning, relying on mushrooms as a viable food source is not worth the risk.

(b) Plants with umbrella-shaped flowers are to be completely avoided, although carrots, celery, dill, and parsley are members of this family. One of the most poisonous plants, poison water hemlock, is also a member of this family (figure 18-26).

(c) All of the legume family should be avoided (beans and peas). They absorb minerals from the soil and cause problems. The most common mineral absorbed is selenium. Selenium is what has given locoweed its fame. (Locoweed is a vetch.)

(d) As a general rule, all bulbs should be avoided. Examples of poisonous bulbs are tulips and death camas.

(e) White and yellow berries are to be avoided as they are almost always poisonous. Approximately one-half of all red berries are poisonous. Blue or black berries are generally safe for consumption.

(f) Aggregated fruits and berries are always edible (for example, thimbleberry, raspberry, salmonberry, and blackberry).

(g) Single fruits on a stem are generally considered safe to eat.

(h) Plants with shiny leaves are considered to be poisonous and caution should be used.

(i) A milky sap indicates a poisonous plant.

(j) Plants that are irritants to the skin should not be eaten, such as poison ivy.

(k) A plant that grows in sufficient quantity within the local area should be selected to justify the edibility test and provide a lasting source of food if the plant proves edible.

(l) Plants growing in the water or moist soil are often the most palatable.

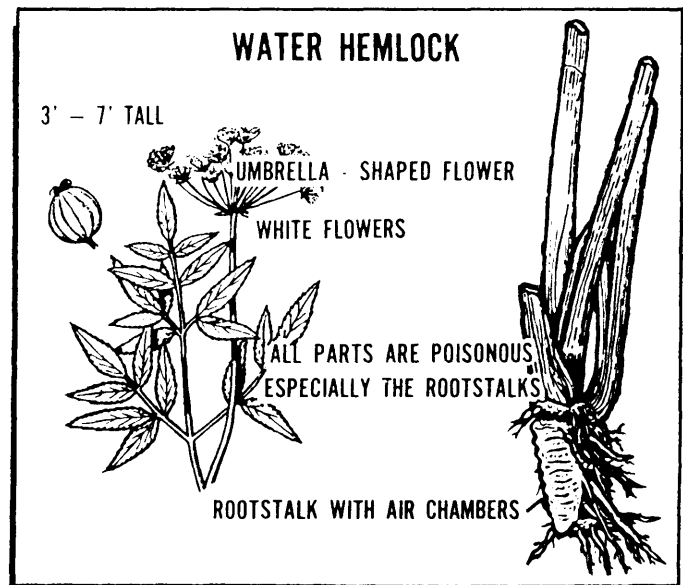

Figure 18-26. Water Hemlock.

(m) Plants are less bitter when growing in shaded areas.

(3) The previously mentioned information concerning plants is general. There are exceptions to every rule, but when selecting unknown plants for consumption, plants with these characteristics should be avoided. Plants that do not have these characteristics should be considered as possible food sources. Apply the edibility test to only one plant at a time so if some abnormality does occur, it will be obvious which plant caused the problem. Once a plant has been selected for the edibility test, proceed as follows:

(a) Crush or break part of the plant to determine the color of its sap. If the sap is clear, proceed to the next step.

(b) Touch the plant's sap or juice to the inner forearm or tip of the tongue. (A small taste of a poisonous plant will not do serious harm.) If there are no ill effects, such as a rash or burning sensation to the skin, bitterness to the taste, or numbing sensation of the tongue or lips, then proceed with the rest of the steps. (NOTE: Sometimes heavy smokers are unable to taste various poisons, such as alkaloids).

(c) Prepare the plant or plant part for consumption by boiling in two changes of water. The toxic properties of many plants are water soluble or destroyed by heat; cooking and discarding in two changes of water lessens the amount of poisonous material or removes it completely. Parboiling is a process of boiling the individual plant parts in repeated changes of water to remove bitter elements. This boiling period should last about 5 minutes.

(d) Place about 1 teaspoonful of the prepared plant food in the mouth for 5 minutes and chew but do not swallow it. A burning, nauseating, or bitter taste is a warning of possible danger. If any of these ill effects occur, remove the material from the mouth at once and discard that plant as a food source. However, if no burning sensation or other unpleasant effect occurs, swallow the plant material and wait 8 hours.

(e) If after this 8 hours there are no ill effects, such as nausea, cramps, or diarrhea, eat about 2 tablespoonfuls and wait an additional 8 hours.

(f) If no ill effects occur at the end of this 8-hour period, the plant may be considered edible.

(g) Keep in mind that any new or strange food should be eaten with restraint until the body system has become accustomed to it. The plant may be slightly toxic and harmful when large quantities are eaten.

(4) If cooking facilities are not available, survivors will not be able to boil the plant before consumption. In this case, plant food may be prepared as follows:

(a) Leach the plant by crushing the plant material and placing it in a container. Pour large quantities of cold water over it (rinse the plant parts). Leaching removes some of the bitter elements of nontoxic plants.

EDIBLE PARTS OF PLANTS	
Underground Parts	Tubers Roots and Rootstalks Bulbs
Stems and Leaves (potherbs)	Shoots and Stems Leaves Pith Bark
Flower Parts	Flowers Pollen
Fruits	Fleshy Fruits (dessert and vegetable) Seeds and Grains Nuts Seed Pods Pulps
Gums and Resins	
Saps	

Figure 18-27. Edible Parts of Plants.

(b) If leaching is not possible, survivors should follow the steps they can in the edibility test.

d. The survivor will find some plants which are completely edible, but many plants which they may find will have only one or more identifiable parts having food and thirst-quenching value. The variety of plant component parts which might contain substance of food value is shown in figure 18-27.

(1) Underground Parts:

(a) Tubers. The potato is an example of an edible tuber. Many other kinds of plants produce tubers such as the tropical yam, the Eskimo potato, and tropical water lilies. Tubers are usually found below the ground. Tubers are rich in starch and should be cooked by roasting in an earth oven or by boiling to break down the starch for ease in digestion. The following are some of the plants with edible tubers.

- | | |
|-----------------------------|----------------------------|
| -1. Arrowroot, East Indian. | -5. Chufa (Nut Grass). |
| -2. Taro. | -6. Water Lily (Tropical). |
| -3. Cassava (Tapioca). | -7. Sweet Potato (Kamote). |
| -4. Bean, Yam. | -8. Yam Tropical. |

(b) Roots and Rootstalks. Many plants produce roots which may be eaten. Edible roots are often several feet in length. In comparison, edible rootstalks are underground portions of the plant which have become thickened, and are relatively short and jointed. Both true roots and rootstalks are storage organs rich in

stored starch. The following are some of the plants with edible roots or rootstalks (rhizomes):

- 1. Baobab.
- 2. Pine, Screw.
- 3. Bean, Goa.
- 4. Plantain, Water.
- 5. Bracken.
- 6. Reindeer Moss.
- 7. Calla, Wild (Water Arum).
- 8. Rock Tripe.
- 9. Polypody.
- 10. Canna Lily.
- 11. Rush, Flowering.
- 12. Cattail.
- 13. Spinach, Ceylon.
- 14. Chicory.
- 15. Ti Plant.
- 16. Horseradish.
- 17. Tree Fern.
- 18. Lotus Lily.
- 19. Water Lily (Temperate Zone).
- 20. Manioc.

(c) Bulbs. The most common edible bulb is the wild onion, which can easily be detected by its characteristic odor. Wild onions may be eaten uncooked, but other kinds of bulbs are more palatable if cooked. In Turkey and Central Asia, the bulb of the wild tulip may be eaten. All bulbs contain a high percentage of starch. (Some bulbs are poisonous, such as the death camas which has white or yellow flowers.) The following are some of the plants with edible bulbs:

- 1. Lily, Wild.
- 2. Tulip, Wild.
- 3. Onion, Wild.
- 4. Blue Camas.
- 5. Tiger Lily.

(2) Shoots and Leaves:

(a) Shoots (Stems). All edible shoots grow in much the same fashion as asparagus. The young shoots

of ferns (fiddleheads) and especially those of bamboo and numerous kinds of palms are desirable for food. Some kinds of shoots may be eaten raw, but most are better if first boiled for 5 to 10 minutes, the water drained off, and the shoots reboiled until they are sufficiently cooked for eating (parboiled). (See figure 18-28).

- 1. Agave (Century Plant).
- 2. Palm, Coconut.
- 3. Purslane.
- 4. Reindeer Moss.
- 5. Bamboo.
- 6. Palm, Fishtail.
- 7. Bean, Goa.
- 8. Palm, Nipa.
- 9. Bracken.
- 10. Palm, Rattan.
- 11. Rhubarb, Wild.
- 12. Cattail.
- 13. Palm, Sago.
- 14. Spinach, Ceylon.
- 15. Rock Tripe.
- 16. Colocynth.
- 17. Palm, Sugar.
- 18. Papaya.
- 19. Sugar Cane.
- 20. Lotus Lily.
- 21. Pokeweed (poisonous roots).
- 22. Sweet Potato-Kamote.
- 23. Luffa Sponge.
- 24. Water Lily (Tropical).
- 25. Polypody.
- 26. Palm, Buri.
- 27. Willow, Arctic.

(b) Leaves. The leaves of spinach-type plants (pothebs), such as wild mustard, wild lettuce, and lamb quarters, may be eaten either raw or cooked. Prolonged cooking, however, destroys most of the vitamins. Plants which produce edible leaves are perhaps the most numerous of all edible plants. The young tender leaves of nearly all nonpoisonous plants are edible. The follow-

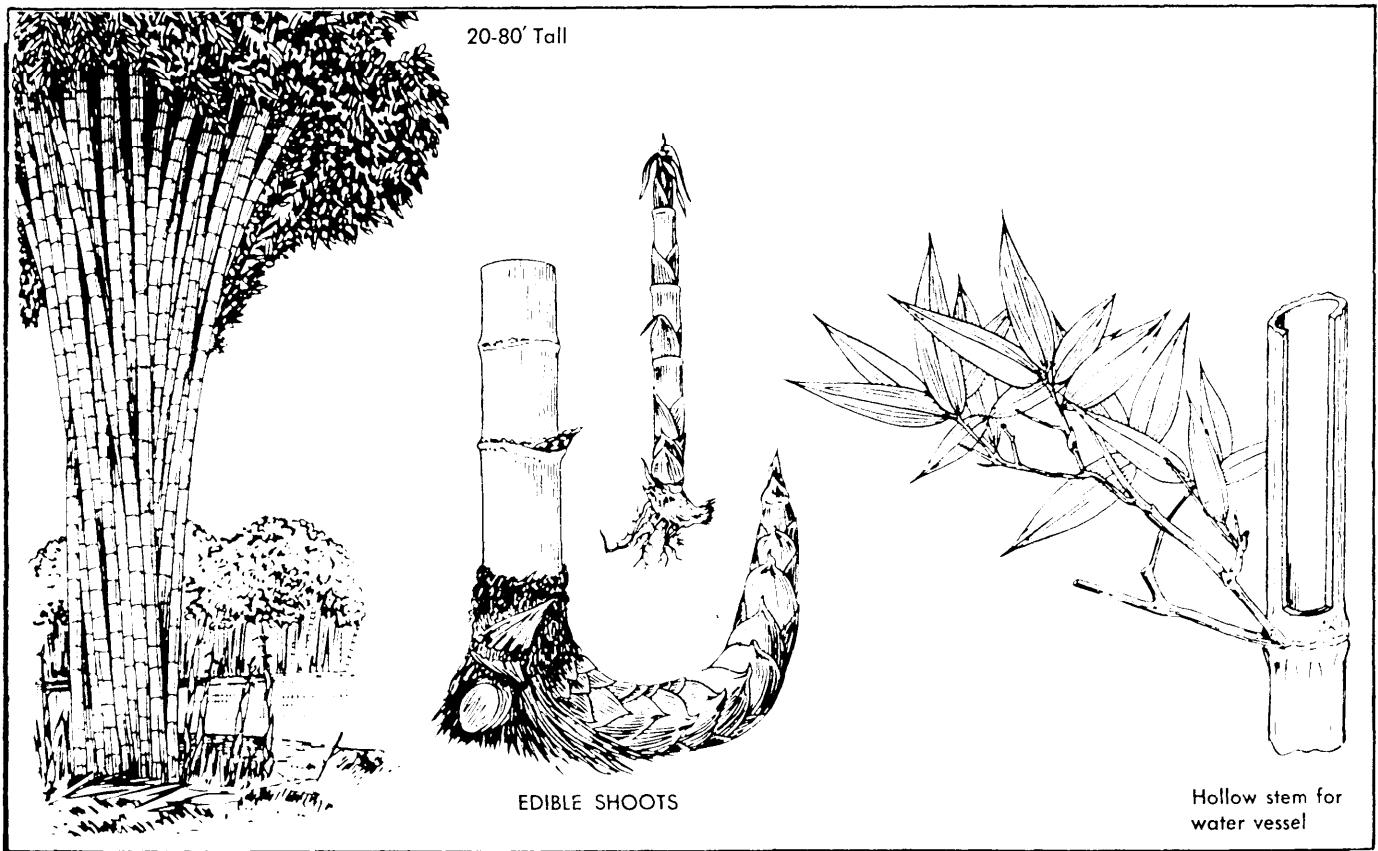

Figure 18-28. Bamboo.

ing are only some of the plants with edible leaves:

- 1. Amarath.
- 2. Luffa Sponge.
- 3. Rock Tripe.
- 4. Avocado.
- 5. Mango.
- 6. Sorrel, Wild.
- 7. Baobab.
- 8. Orach, Sea.
- 9. Bean, Goa.
- 10. Papaya.
- 11. Spinach, Ceylon.
- 12. Cassava.
- 13. Chickory.
- 14. Pine, Screw.
- 15. Spreading Wood Fern.
- 16. Dock.
- 17. Plantain.
- 18. Pokeweed (poisonous roots).
- 19. Sweet Potato-Kamote.
- 20. Tamarind.
- 21. Horseradish.
- 22. Prickly Pear.
- 23. Taro (only after cooking).
- 24. Lettuce, Water.
- 25. Purslane.
- 26. Ti Plant.
- 27. Willow, Arctic.
- 28. Lotus Lily.
- 29. Reindeer Moss.

(c) Pith. Some plants have an edible pith in the center of the stem. The pith of some kinds of tropical plants is quite large. Pith of the sago palm is particularly valuable because of its high food value. The following are some of the palms with edible pith (starch):

- 1. Buri.
- 2. Fishtail.
- 3. Sago.
- 4. Coconut.
- 5. Rattan.
- 6. Sugar.

(d) Bark. The inner bark of a tree—the layer next to the wood—may be eaten raw or cooked. It is possible in northern areas to make flour from the inner bark of such trees as the cottonwood, aspen, birch, willow, and pine. The outer bark should be avoided in all cases because this part contains large amounts of bitter tannin. Pine bark is high in vitamin C. The outer bark of pines can be cut away and the inner bark stripped from the trunk and eaten fresh, dried, or cooked, or it may be pulverized into flour. Bark is most palatable when newly formed in spring. As food, bark is most useful in the arctic regions, where plant food is often scarce.

(3) Flower Parts:

(a) Flowers and Buds. Fresh flowers may be eaten as part of a salad or to supplement a stew. The hibiscus flower is commonly eaten throughout the southwest Pacific area. In South America, the people of the Andes eat nasturtium flowers. In India, it is common to eat the flowers of many kinds of plants as part of a vegetable curry. Flowers of desert plants may also be eaten. The

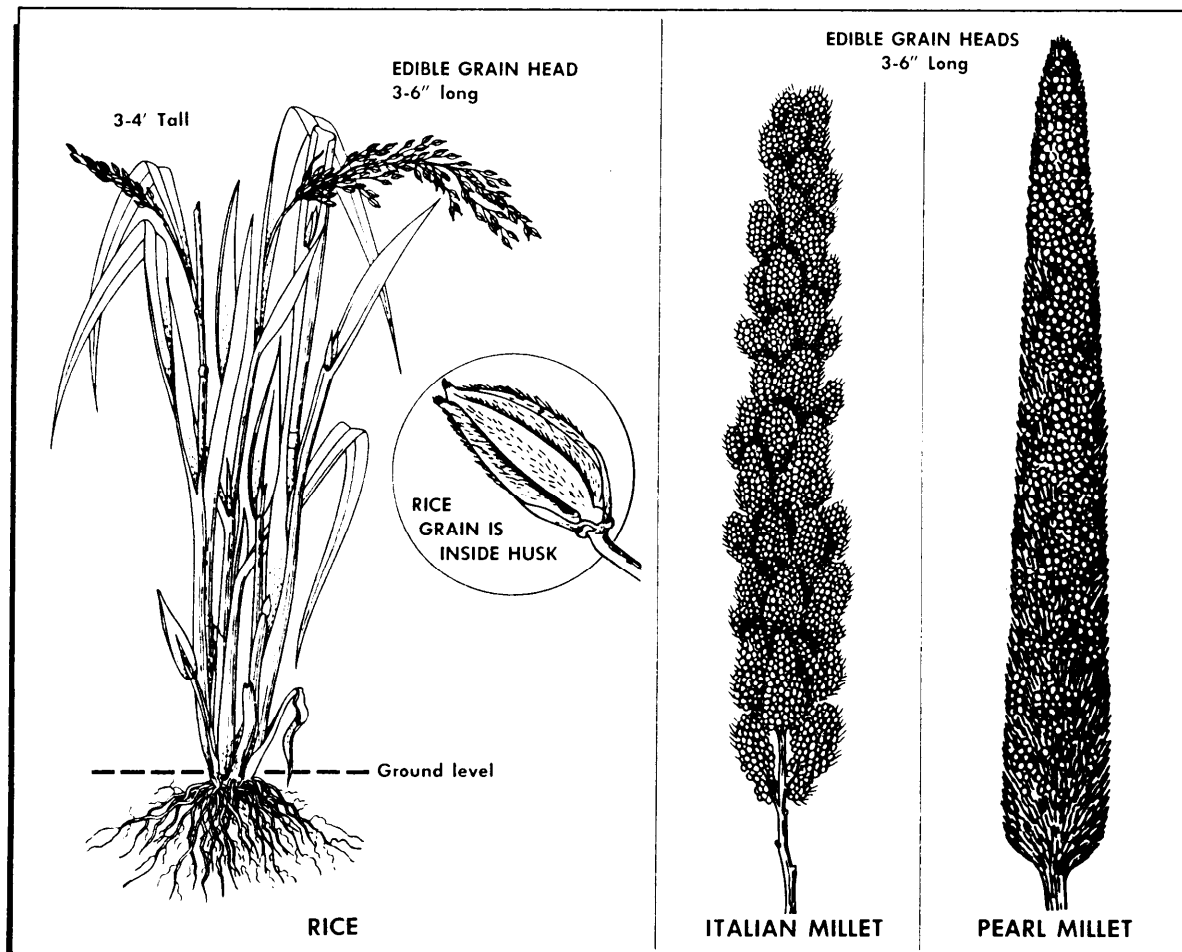

Figure 18-29. Grains.

following are plants with edible flowers:

- | | |
|----------------|-------------------|
| -1. Abal. | -5. Horseradish. |
| -2. Colocynth. | -6. Caper, Wild. |
| -3. Papaya. | -7. Luffa Sponge. |
| -4. Banana. | |

(b) Pollen. Pollen looks like yellow dust. All pollen is high in food value and in some plants, especially the cattail. Quantities of pollen may easily be collected and eaten as a kind of gruel.

(4) Fruits. Edible fruits can be divided into sweet and nonsweet (vegetable) types. Both are the seed bearing parts of the plant. Sweet fruits are often plentiful in all areas of the world where plants grow. For instance, in the far north, there are blueberries and crowberries; in the temperate zones, cherries, plums, and apples; and in the American deserts, fleshy cactus fruits. Tropical areas have more kinds of edible fruit than other areas, and a list would be endless. Sweet fruits may be cooked, or for maximum vitamin content, left uncooked. Common vegetable fruits include the tomato, cucumber, and pepper.

(a) Fleshy Fruits (Sweet). The following are plants with edible fruits:

- | | |
|----------------------|----------------------|
| -1. Apple, Wild. | -13. Jackfruit. |
| -2. Bael Fruit. | -14. Jujube, Common. |
| -3. Banana. | -15. Mango. |
| -4. Bignay. | -16. Mulberry. |
| -5. Blueberry, Wild. | -17. Papaya. |
| -6. Bullocks Heart. | -18. Plum, Batako. |
| -7. Cloudberry. | -19. Pokeberry. |
| -8. Crabapple. | -20. Prickly Pear. |
| -9. Cranberry. | -21. Rose Apple. |
| -10. Fig, Wild. | -22. Soursop. |
| -11. Grape, Wild. | -23. Sweetsop. |
| -12. Huckleberry. | |

(b) Fleshy Fruits (Vegetables). The following are plants with edible fruits (vegetables):

- | | |
|------------------|-------------------|
| -1. Breadfruit. | -4. Caper, Wild. |
| -2. Horseradish. | -5. Luffa Sponge. |
| -3. Plantain. | |

(c) Seeds and Grains. Seeds of many plants, such as buckwheat, ragweed, amaranth, and goosefoot, contain oils and are rich in protein. The grains of all cereals and many other grasses, including millet, are also extremely valuable sources of plant protein. They may either be ground between stones, mixed with water and cooked to make porridge, parched or roasted over hot stones. In this state, they are still wholesome and may be kept for long periods without further preparation (figure 18-29). The following are some of the plants with edible seeds and grains:

- | | |
|----------------------|-----------------------------|
| -1. Amaranth. | -6. Palm, Nipa. |
| -2. Millet, Italian. | -7. Tamarind. |
| -3. Rice. | -8. Pine, Screw. |
| -4. Bamboo. | -9. Colocynth. |
| -5. Millet, Pearl. | -10. Water Lily (Tropical). |

- | | |
|------------------------|------------------------------|
| -11. Sterculia. | -16. Lotus Lily. |
| -12. Baobab. | -17. Purslane. |
| -13. Orach, Sea. | -18. Water Lily (Temperate). |
| -14. St. John's Bread. | -19. Luffa Sponge. |
| -15. Bean, Goa. | |

(d) Nuts. Nuts are among the most nutritious of all raw plant foods and contain an abundance of valuable protein. Plants bearing edible nuts occur in all the climatic zones of the world and in all continents except in the arctic regions. Inhabitants of the temperate zones are familiar with walnuts, filberts, almonds, hickory nuts, acorns, hazelnuts, beechnuts, and pine nuts, to mention just a few. Tropical zones produce coconuts and other palm nuts, brazil nuts, cashew nuts, and macadamia nuts (figure 18-30). Most nuts can be eaten raw but some such as acorns, are better when cooked. The following are some of the plants with edible nuts:

- | | |
|----------------------------------|----------------------------|
| -1. Almond. | -8. Filbert (Hazelnut). |
| -2. Chestnut, Water (Trapa Nut). | -9. Palm, Fishtail. |
| -3. Palm, Buri | -10. Jackfruit Seeds. |
| -4. Almond, Indian or Tropical. | -11. Oak, English (Acorn). |
| -5. Chestnut, Mountain. | -12. Palm, Sago. |
| -6. Palm, Coconut. | -13. Palm, Sugar. |
| -7. Beechnut. | -14. Pine. |
| | -15. Pistachio, Wild. |
| | -16. Walnut. |

(e) Pulp. The pulp around the seeds of many fruits is the only part that can be eaten. Some fruits produce sweet pulp; others have a tasteless or even bitter pulp. Plants that produce edible pulp include the custard apple, inga pod, breadfruit, and tamarind. The pulp of breadfruit must be cooked, whereas in other plants, the pulp may be eaten uncooked. Use the edibility rules in all cases of doubt.

(5) Gums and Resins. Gum and resin are sap that collects and hardens on the outside surface of the plant. It is called gum if it is soft and soluble, and resin if it is hard and not soluble. Most people are familiar with the gum which exudes from cherry trees and the resin which seeps from the pine trees. These plant byproducts are edible and are a good source of nutritious food which should not be overlooked.

(6) Saps. Vines or other plant parts may be tapped as potential sources of usable liquid. The liquid is obtained by cutting the flower stalk and letting the fluid drain into some sort of container such as a bamboo section. Palm sap with its high-sugar content is highly nutritious. The following are some plants with edible sap and drinking water:

- | | |
|----------------------------|---------------------------|
| (a) Acacia, Sweet (water). | (i) Palm, Rattan (water). |
| (b) Colocynth (water). | (j) Cactus (water). |
| (c) Palm, Coconut (sap). | (k) Grape (water). |
| (d) Palm, Fishtail (sap). | (l) Banana (water). |
| (e) Agave (water). | (m) Palm, Sago (sap). |
| (f) Cuipo Tree (water). | (n) Palm, Sugar (sap). |
| (g) Saxual (water). | (o) Palm, Buri (sap). |
| (h) Palm, Nipa (sap). | |

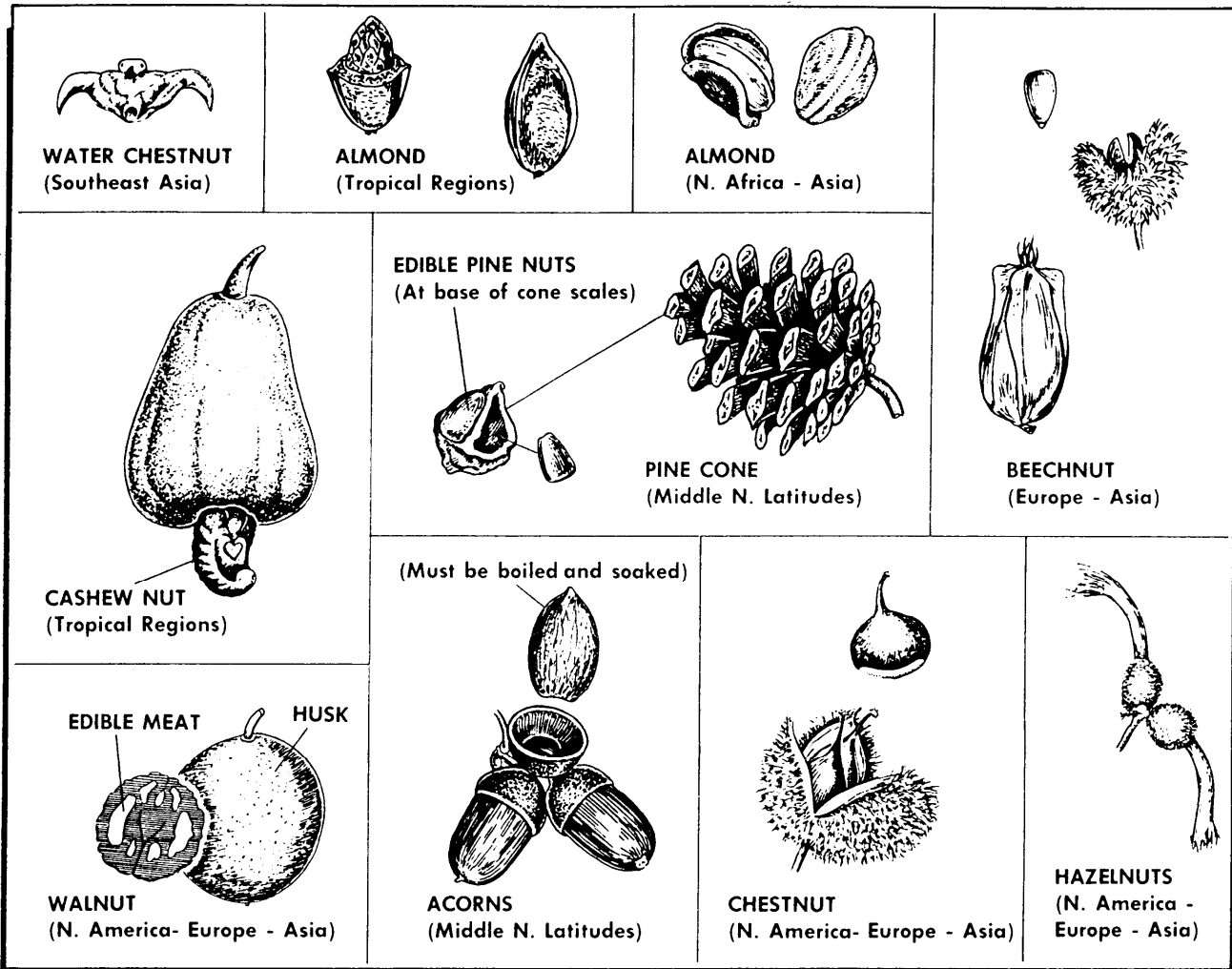

Figure 18-30. Edible Nuts.

18-6. Food in Tropical Climate. There are more types of animals in the jungles of the world than in any other region. A jungle visitor who is unaware of the life style and eating habits of these animals would not observe the presence of a large number of the animals.

a. Game trails are the normal routes along which animals travel through a jungle. Some of the animals used as food are hedgehogs, porcupines, anteaters, mice, wild pigs, deer, wild cattle, bats, squirrels, rats, monkeys, snakes, and lizards.

(1) Reptiles are located in all jungles and should not be overlooked as a food source. All snakes should be considered poisonous and extreme caution used when killing the animal for a food source. All cobras should be avoided since the spitting cobra aims for the eyes; the venom can blind if not washed out immediately. Lizards are good food, but may be difficult to capture since they can be extremely fast. A good blow to the head of a reptile will usually kill it. Crocodiles and caimans are extremely dangerous on land as well as in the water.

(2) Frogs can be poisonous; all brilliantly colored

frogs should be totally avoided. Some frogs and toads in the tropics secrete substances through the skin which has a pungent odor. These frogs are often poisonous.

(3) The larger, more dangerous animals such as tigers, rhinoceros, water buffalo, and elephants are rarely seen and should be left alone. These larger animals are usually located in the open grasslands.

b. Seafood such as fish, crabs, lobsters, crayfish, and small octopi can be poked out of holes, crevices, or rock pools (figure 18-31). Survivors should be ready to spear them before they move off into deep water. If they are in deeper water, they can be teased shoreward with a baited hook, or a stick.

(1) A small heap of empty oysters shells near a hole may indicate the presence of an octopus. A baited hook placed in the hole will often catch the octopus. The survivor should allow the octopus to surround the hook and line before lifting. Octopi are not scavengers like sharks, but they are hunters, fond of spiny lobster and other crab-like fish. At night, they come into shallow water and can be easily seen and speared.

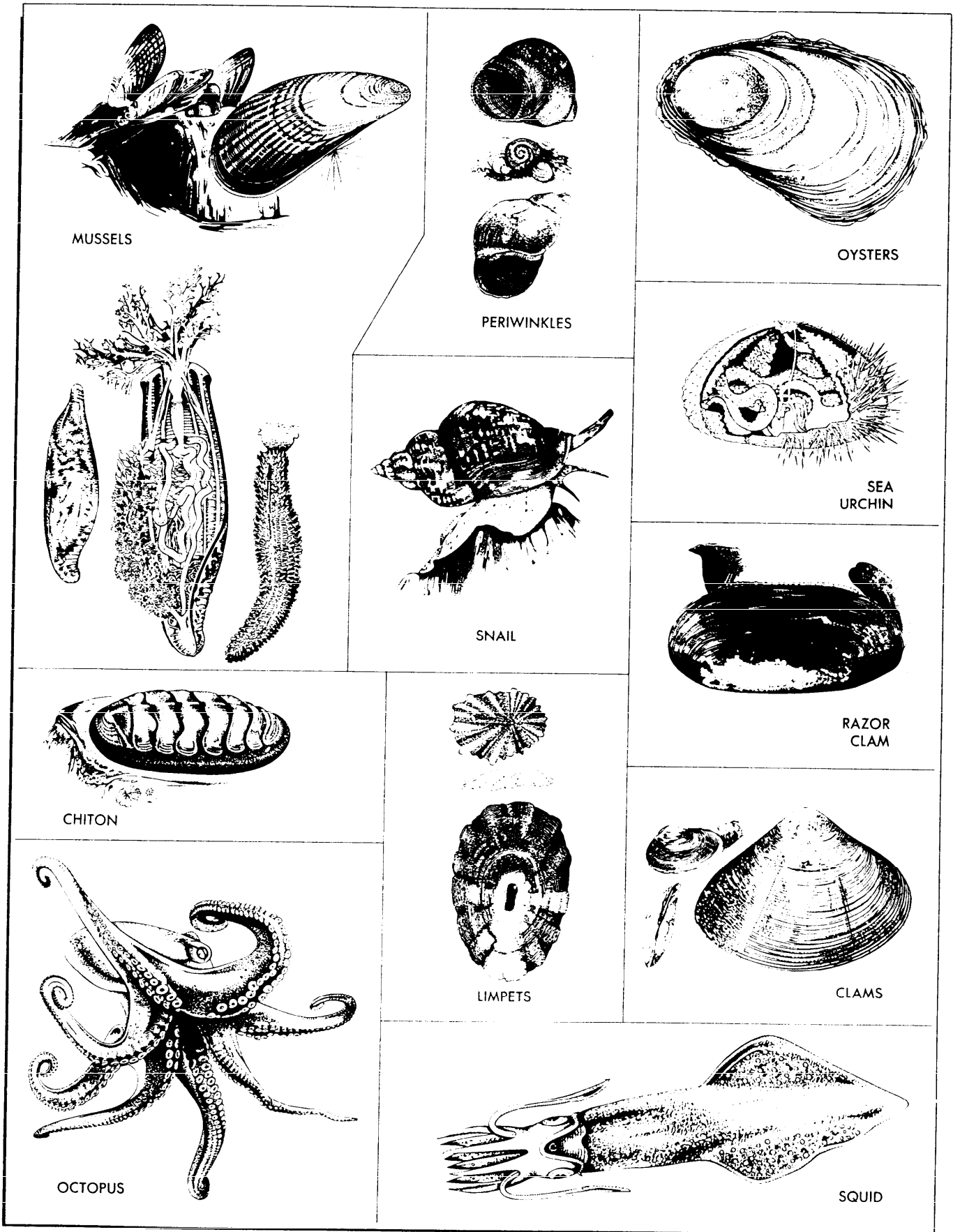

Figure 18-31. Edible Invertebrates.

(2) Snails and limpets cling to rocks and seaweed from the low-water mark up. Large snails called chitons adhere tightly to rocks just above the surf line.

(3) Mussels usually form dense colonies in rock pools, on logs, or at the bases of boulders. *Mussels are poisonous in tropical zones during the summer, especially when seas are highly phosphorescent or reddish.*

(4) Sluggish sea cucumbers and conchs (large snails) live in deep water. The sea cucumber will shoot out its stomach when excited. The stomach is not edible. The skin and the five strips of muscle can be eaten after boiling. Conches can be boiled out of their shells and have very firm flesh. Use care when picking conches up. The bottom of their "foot" has a boney covering which can severely cut the survivor who procures it.

(5) The safest fish to eat are those from the open sea or deep water beyond the reef. Silvery fishes, river eels, butterfly fishes, and flounders from bays and rivers are good to eat.

(6) Land crabs are common on tropical islands and are often found in coconut groves. An open coconut can be used for bait.

(7) A number of methods can be used for procuring fish.

(a) Hook-and-Line Fishing. This type of fishing on a rocky coast requires a lot of care to keep the line from becoming entangled or cut on sharp edges. Most shallow-water fish are nibblers. Unless the bait is well placed and hooked and the barb of the hook offset by bending, the bait may be lost without catching a fish. Use hermit crabs, snails, or the tough muscle of a shellfish as bait. Take the cracked shells and any other animal remains and drop them into the area to be fished. This brings the fish to the area and provides a better procurement opportunity. Examine stomach contents of the first fish caught to determine what the fish are feeding on.

(b) Jigging. A baited or spooned hook dipped repeatedly beneath the surface of the water is sometimes effective. This method may be used at night.

(c) Spearing. This method is difficult except when the stream is small and the fish are large and numerous during the spawning season, or when the fish congregate in pools. Make a spear by sharpening a long piece of wood, lashing two long thorns on a stick, or fashioning a bone spear point, and take a position on a rock over a fish run. Wait patiently and quietly for a fish to swim by.

(d) Chop Fishing. Chop fishing is effective at night during low tide. This method requires a torch and a machete. The fish are attracted by the light of the torch, and then they may be stunned by slashing at them with the *back* of the machete blade. Care should be taken when swinging the machete (figure 18-32).

c. The jungle environment has a uniquely favorable condition for plant and animal life. The variety and richness of plant growth in these areas are paralleled

nowhere else on the Earth. Because the rainfall is distributed throughout the year and there is a lack of cold seasons, plants in the humid regions can grow, produce leaves, and flower the year round. Some plants grow very rapidly. For example, the stem of the giant bamboo may grow more than 22 inches in a single day.

(1) A survivor in search of plant food should apply some basic principles to the search. A survivor is lucky to find a plant that can readily be identified as edible. If a plant resembles a known plant, it is very likely to be of the same family and can be used. If a plant cannot be identified, the edibility test should be applied. A survivor will find many edible plants in the tropical forest, but chances of finding them in abundance are better in an area that has been cultivated in the past (secondary growth).

(2) Some plants a survivor might find:

(a) Citrus fruit trees may be found in uncultivated areas, but are primarily limited to areas of secondary growth. The many varieties of citrus fruit trees and shrubs have leaves 2 to 4 inches long alternately arranged. The leaves are leathery, shiny, and evergreen. The leaf stem is often winged. Small (usually green) spines are often present by the side of the bud. The flowers are small and white to purple in color. The fruit has a leathery rind with numerous glands and is round and fleshy with several cells (fruit sections or slices) and many seeds. The great number of wild and cultivated fruits (oranges, limes, lemons, etc.) native to the tropics are eaten raw or used in beverages.

(b) Taro can be found in both secondary growth and in virgin areas. It is usually found in the damp, swampy areas in the wild, but certain varieties can be found in the forest. It can be identified by its large heart-shaped or arrowhead-shaped leaves growing at the top of a vertical stem. The stem and leaves are usually green and rise a foot or more from a tuber at the base of the stem. Taro leaf tips point down; poisonous elephant ear points up. All varieties of taro must be cooked to break down the irritating crystals in the plant.

(c) Wild pineapple can be found in the wild, and common pineapples may be found in secondary growth areas. The wild pineapple is a coarse plant with long clustered, sword-shaped leaves with sawtoothed edges. The leaves are spirally arranged in a rosette. Flowers are violet or reddish. The wild pineapple fruit will not be as fully developed in the wild state as when cultivated. The seeds from the flower of the plant are edible as well as the fruit. The ripe fruit may be eaten raw, but the green fruit must be cooked to avoid irritation. (The leaf fibers make excellent lashing material and ropes can be manufactured from it.)

(d) Yams may be found cultivated or wild. There are many varieties of yam, but the most common has a vine with square-shaped cross section and two rows of heart-shaped leaves growing on opposite sides of the vine. The vine can be followed to the ground to locate



Figure 18-32. Chop Fishing.

the tuber. The tubers should be cooked to destroy the poisonous properties of the plant (figure 18-33).

(e) Ginger grows in the tropical forest and is a good source of flavoring for food. It is found in shaded areas of the primary forest. The ginger plant grows 5 to 6 feet high. It has seasonal white snapdragon-type flowers, some variations have red flowers. The leaves when crushed produce a very sweet odor and are used for seasoning or tea. The tea is used by primitive people to treat colds and fever.

(f) The coconut palm is found wild on the sea-coast and in farmed areas inland. It is a tree 50 to 100 feet high, either straight or curved, marked with ring-like leaf scars. The base of the tree is swollen and surrounded by a mass of rootlets. The leaves are leathery and reach a length of 15 to 20 feet. (The leaves make excellent sheathing for shelter.) The fruit grows in clusters at the top of the tree. Each nut is covered with a fibred hard shell. The "heart" of the coconut palm is edible and is found at the top. (The new leaves grow out of the heart.) Cut the tree down and remove the leaves to gain access to the heart. The flower of the coconut tree is also edible and is best used as a cooked vegetable. The germinating nut is filled with a meat that can be

eaten raw or cooked. There are many other varieties of palm found in the tropics which have edible hearts and fruits (figure 18-34).

(g) The papaya is an excellent source of food and can be found in secondary growth areas. The tree grows to a height of 6 to 20 feet. The large, dark green, many fingered, rough-edged leaves are clustered at the top of the plant. The fruit grows on the stem clustered under the leaves. The fruit is small in the wild state, but cultivated varieties may grow to 15 pounds. The peeled fruit can be eaten raw or cooked. The peeling should never be eaten. The green fruit is usually cooked. The milky sap of the green fruit is used as a meat tenderizer; care should be taken not to get it in the eyes. Always wash the hands after handling fresh green papayas. If some of the sap does get in the eyes, they should be washed immediately (figure 18-35).

(h) Cassava (tapioca) can be found in secondary growth areas. It can be identified by its stalk-like leaves which are deeply divided into numerous pointed sections or fingers. The woody (red) stem of the plant is slender and at points appears to be sectioned. When found growing wild in secondary growth areas, pull the trunks to find where a root grows. When one is found, a tuber can be dug. Tubers have been found growing around a portion of the stem that was covered with vegetation. The brown tuber of the plant is white inside and must be boiled or roasted. The tuber must also be peeled before boiling. (The green-stemmed species of cassava is poisonous and must be cooked in several changes of water before eating it.)

(i) Ferns can be found in the virgin tropical forest or in secondary growth areas. The new leaves (fiddle heads) at the top are the edible parts. They are covered with fuzzy hair which is easily removed by rubbing or washing. Some can be eaten raw, but as a rule, should be cooked as a vegetable (figure 18-36).

(j) Sweet sops can be found in the tropical forest. It is a small tree with simple, oblong leaves. The fruit is shaped like a blunt pine cone with thick grey-green or yellow, brittle spines. The fruit is easily split or broken when ripe, exposing numerous dark brown seeds imbedded in the cream colored, very sweet pulp.

(k) The star apple is common in the tropical forests. The tree grows up to a height of 60 feet and can be identified by the leaves which have shiny, silky, brown hairs on the bottom. The fruit looks like a small apple or plum with a smooth greenish or purple skin. The meat is greenish in color and milky in texture. When cut through the center, the brown, elongated seeds make a figure like a 6- or 10-pointed star. The fruit is sweet and eaten only when fresh. When cut, the rind will, like other parts of the tree, emit a white sticky juice or latex which is not poisonous (an exception to the milky sap rule).

(3) Of the 300,000 different kinds of wild plants in the world, a large number of them are found in the

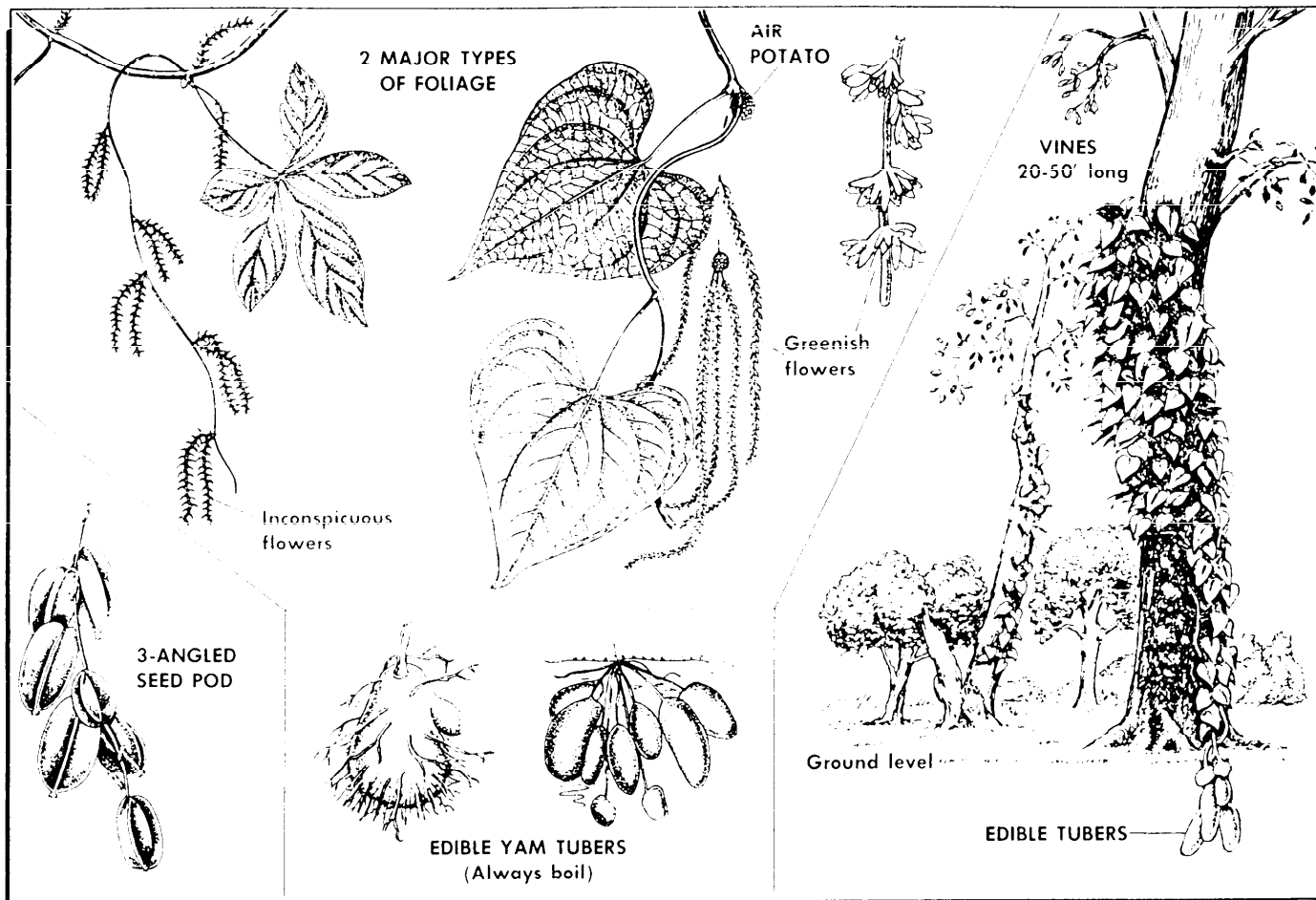

Figure 18-33. Yams.

tropics and many of them are potentially edible. Very few are deadly when eaten in small quantities. Those which are poisonous may be detected by using the edibility rules. Only a small number of jungle plants have been discussed. It would be of great benefit to anyone flying over or passing through a tropical environment to study the plant foods available in this type of environment.

18-7. Food in Dry Climates. Although not as readily available as in the tropical climate, food is available and obtainable.

a. Plant life in the desert is varied due to the different geographical areas. It must be remembered, therefore, that available plants will depend on the actual desert, the time of year, and if there has been any recent rainfall. The aircrew member should be familiar with plants in the area to be flown over.

(1) Date palms are located in most deserts and are cultivated by the native people around oases and irrigation ditches. They bear a nutritious, oblong, black fruit (when ripe).

(2) Fig trees are normally located in tropical and subtropical zones; however, a few species can be found in the deserts of Syria and Europe. Many kinds are cultivated. The fruit can be eaten when ripe. Most figs resemble a top or a small pear somewhat squashed in shape. Ripe figs vary greatly as to palatability. Many are hard, woody, covered with irritating hairs, and worthless as survival food. The edible varieties are soft, delectable, and almost hairless. They are green, red, or black when ripe.

(3) Millet, a grain bearing plant, is grown by natives around oases and other water sources in the Middle East deserts.

(4) The fruit of all cacti are edible. Some fruits are red, some yellow, but all are soft when ripe. Any of the flat leaf variety, such as the prickly pear, can be boiled and eaten as greens (like spinach) if the spines are first removed. During severe droughts, cattlemen burn off the spines and use the thick leaves for fodder. Although the cactus originates in the American deserts, the prickly pear has been introduced to the desert edges in Asia.

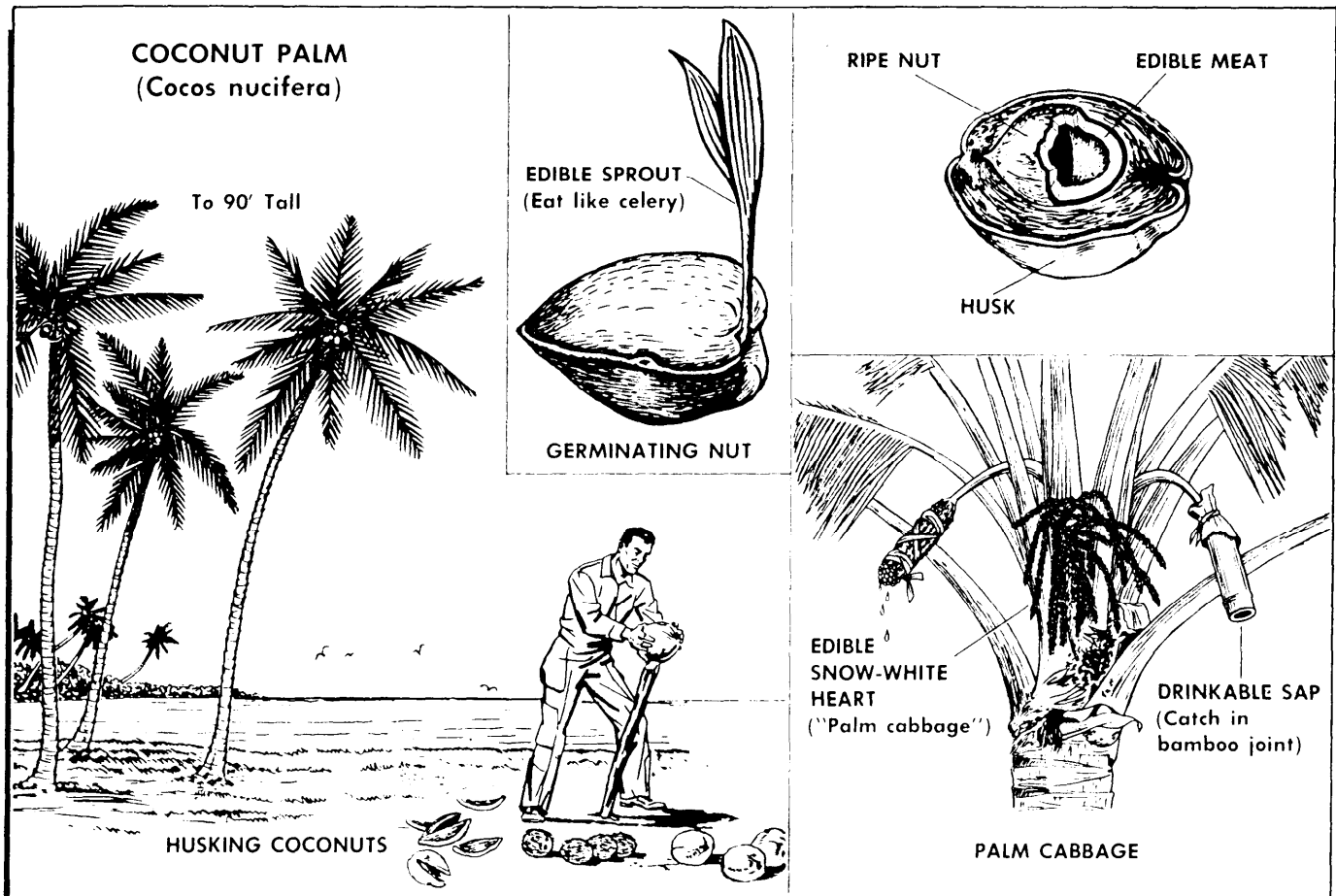

Figure 18-34. Coconut Palm.

Africa, the Near East, and Australia, where it grows profusely. Natives eat the fruit as fast as it ripens.

(5) There are two types of onions in the Gobi desert. A hot, strong, scallion-type grows in the late summer. It will improve the taste of food, but should not be used as a primary food. The highland onions grow 2 to 2.5 inches in diameter. These can be eaten like apples and the greens can also be eaten raw or cooked.

(6) All desert flowers can be eaten except those with milky or colored sap.

(7) All grasses are edible. Usually the best part is the whitish tender end that shows when the grass stalk is pulled from the ground. All grass seeds are edible.

b. Animal food sources may be used to supplement diets and provide needed protein and fats. When looking at a desert area, it is sometimes difficult to visualize an abundance of animal life existing in it. There is, however, a great quantity of animal life present. Most are edible, but some may be hazardous to a survivor during the procurement stage. Some of the abundant animal life includes:

(1) At the peak of seasonal plant growth, the desert crawls and buzzes with an enormous number and varie-

ty of beetles, ants, wasps, moths, and bugs. They appear with the first good rains and generally feed during nighttime. The Ute Indians of North America have harvested crickets, and peoples of the Middle East have roasted locusts. The human diet in Mexico and the American Indians of the Southwest frequently includes grasshoppers and caterpillars.

(2) On the Playas of the Sonora and Chichuahua deserts, several species of freshwater shrimp appear every summer in warm temporary ponds. In the Mohave Desert, where summer rains are rare, they may appear only a few times in a century.

(3) Snakes, lizards, tortoises, etc., have adapted well to the desert environment. Care must be observed when procuring them as some are hazardous, such as the Gila monster and rattlesnake. The desert tortoise, about a foot long when full grown, lives in some of the harshest regions of the Mohave and Sonora deserts. It is club footed, herbivorous, and can crawl about 20 feet per minute. The tortoise converts some of its food into water which is stored for the hot months in two sacs under the upper shell. A pint of water lasts the dry season. In spring and fall, the tortoise browses in broad

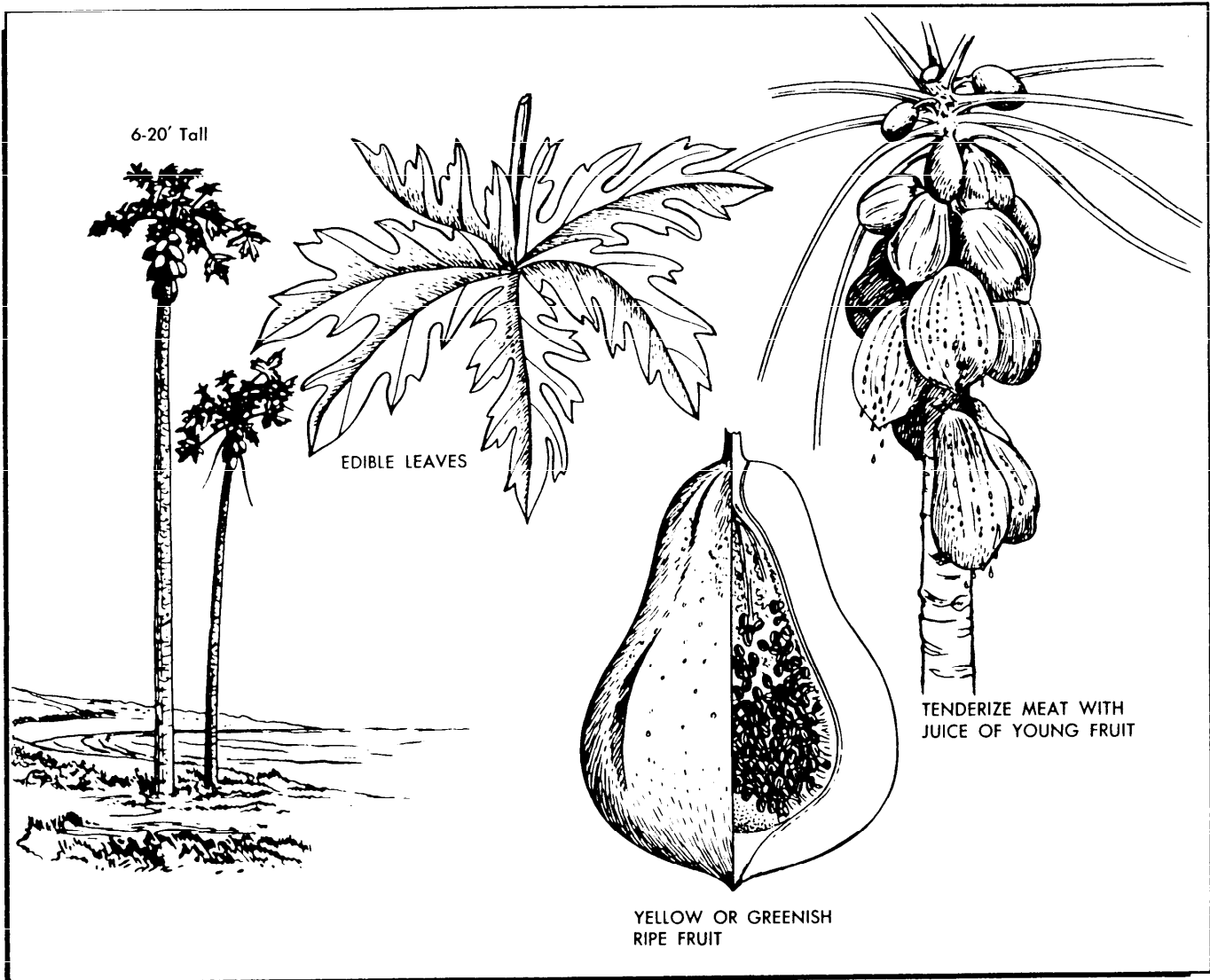

Figure 18-35. Papaya.

daylight, becoming livelier as the day warms up. In the heat of the summer, it comes out of its shallow burrow in the early morning, the late evening, or not at all.

(4) In general, desert birds stay in areas of heavier vegetation and many need water daily; therefore, most will be found within short flights of some type of water source. Many birds will migrate during the drought season. If an abundance of birds is seen, insects, vegetation, and a water source will normally be nearby.

(5) Rabbits, prairie dogs, and rats have learned to live in deserts. They remain in the shade or burrow into the ground protecting themselves from the direct sun and heated air as well as from the hot desert surface.

(6) Larger mammals are also found in the desert. This group consists of gazelles, antelope, deer, foxes, small cats, badgers, dingos, hyenas, etc., and are amazingly abundant. Most are nocturnal and generally avoid humans. They roam at night eating smaller game and

insects; a few eat plants; and a few can be hazardous to a survivor. Any of these mammals should be approached with caution.

(7) Only a few of the available animals and plants have been discussed. If the possibility of having to survive in a desert area exists, the aircrew member should try to become familiar with the food source available in that area.

18-8. Food in Snow and Ice Climates. In the snow and ice climates, food is more difficult to find than water. Animal life is normally more abundant during the warm months, but it can still be found in the cold months. Fish are available in most waters during the warmer months but they congregate in deep waters, large rivers, and lakes during the cold months. Some edible plant life can be found throughout the year in most areas of the arctic.

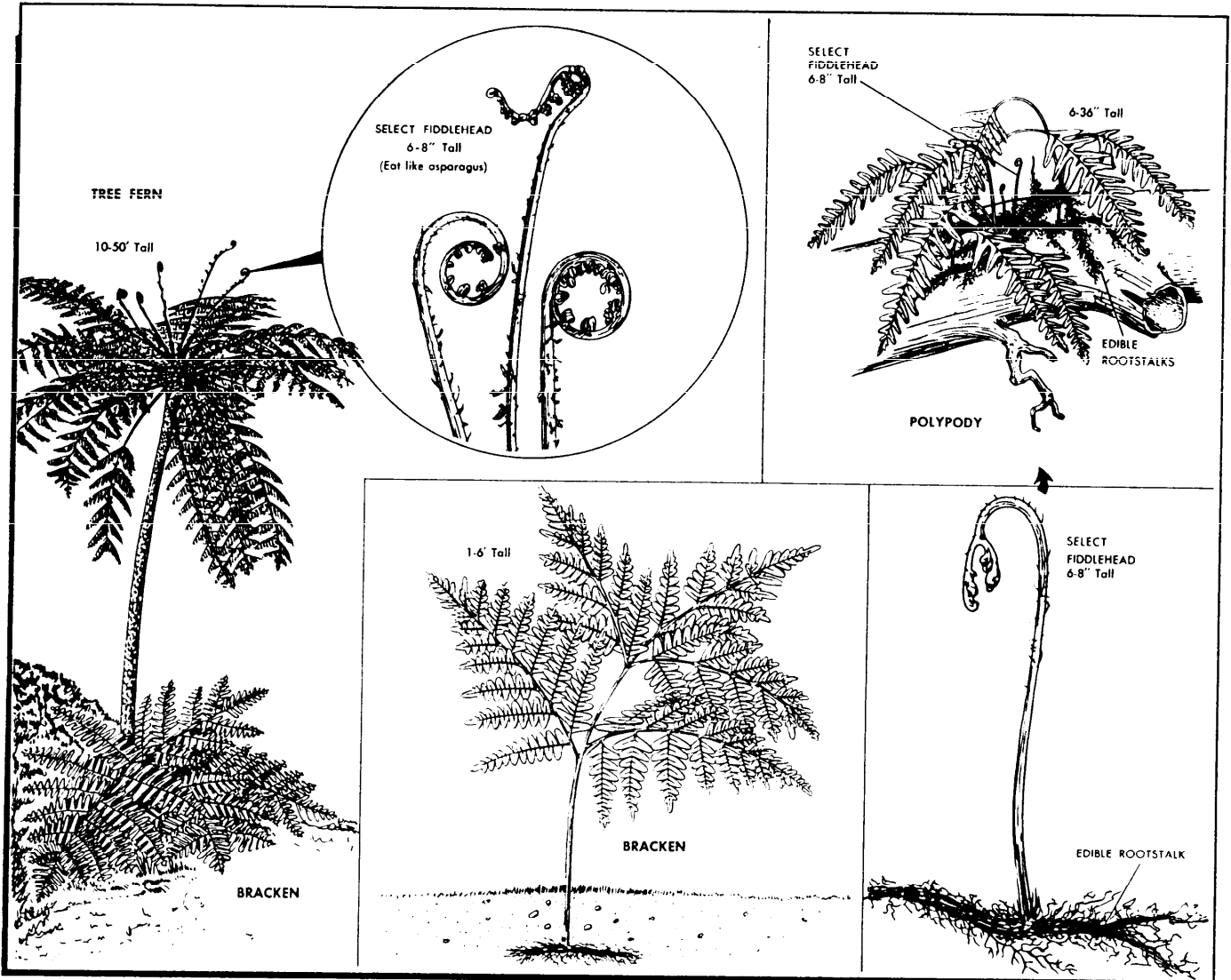

Figure 18-36. Edible Ferns.

a. All animals in the arctic regions are edible, but the livers of seals and polar bears must not be eaten because of the high concentration of vitamin A. Death could result from ingesting large quantities of the liver. On the open sea ice, game animals such as seal, walrus, polar bear, and fox are available. Many types of birds can be found during the warmer months. Fish can be caught throughout the year.

(1) Seal will probably be the main source of food when stranded on the open sea ice. They can be found in open leads, areas of thin ice, or where snow has drifted over a pressure ridge forming a cave which could have open water or very thin ice. These areas may also house polar bears which feed primarily on seals. Polar bears should be avoided.

(a) Newborn seals have trouble staying afloat or swimming and will be found on the ice in the early

summer. The seal cubs can be easily killed with a club, spear, knife, or firearm and make an excellent source of food. The meat, blubber (fat), and coagulated milk in their stomachs are edible. When killing a cub, it is best to keep a lookout for the mother. She tends to protect offspring in any way possible.

(b) Seals must surface periodically to breathe. When the icepack is thin, the seals poke their noses through the ice and take a breath of air in a lead or in open water. In thick ice, the seal will chew and (or) claw a breathing hole through the ice. Normally most seals will have more than one breathing hole. In hunting seals, it is best to take a position beside a breathing hole and wait until a seal comes up to breathe, then spear or strike it on the head with a club. Seals are very sensitive to blows on or about the nose. They will often lose consciousness but not die. A hook can be suspended

through the breathing hole so it hangs down at least 6 inches below the ice. When a seal comes to breathe, it can become hooked when it tries to depart the breathing hole. Seals can be recovered by gaffing or grabbing by hand, but in some cases, the breathing hole might have to be enlarged to pull the body through. If the seal is killed in open water, a "manak" or "grapple hook" can be used to retrieve it. All seals killed in open water or those that fall into open water should be recovered immediately. During the cold months, they will float for quite awhile, but during the warm months or when a female is nursing young, they sink rapidly. This is due to the loss of body fat (figure 18-37).

(2) Birds are plentiful during the summer months and can be procured by spearing, clubbing, catching with a baited fishhook, or use of a weapon.

(3) On tundra areas, there are large game, small game, and birds available as a food source.

(a) The large game consists of caribou, musk oxen, sheep, wolf, and bears (figure 18-38). Even though the large game animals can be a food source, they will be difficult to procure if a firearm is not available. Therefore, they should be considered a hazard to a survivor without a firearm. In the spring, bears tend to congregate along rivers and streams due to the amount

of food available—normally salmon. During the fall, bears will be found feeding at berry patches. During certain seasons of the year, these areas should be avoided.

(b) Small game animals of the tundra include hares, lemmings, mice, ground squirrels, marmots, and foxes. They may be trapped or killed the entire year. When snaring, it is best to use a simple loop made of strong line or wire. The wire must be a two-strand twisted wire since metal becomes brittle in the cold and breaks very easily. Other snares and triggers will be less effective in the cold climate. A gill net can be used as a snare by spreading it across a trail so that the animal will entangle itself.

(c) Surface water is generally plentiful due to the number of lakes, ponds, bogs, and marshes. Water fowl and birds are very abundant during the warm months and include ducks, terns, geese, gulls, owls, and ptarmigan. The eggs and young birds are an excellent food source and can be easily procured (figure 18-39).

(4) As in the tundra areas, the forested areas in the arctic and arctic-like areas abound in wildlife.

(a) The large game species include moose, deer, caribou, and bear.



Figure 18-37. Walrus.



Photo by Joe Mazzone

Figure 18-38. Big Horn Sheep.

(b) Small game of the forests includes hares, squirrels, porcupine, muskrat, and beaver. They can be snared or trapped easily in winter or summer. Small animal trails can be found in the winter with great ease. Most animals do not like to travel in deep snow so they tend to travel the same trail most of the time and this trail will look like a small superhighway — the snow packed down well below the normal snow level. Most trails will also be located in heavy cover or undergrowth or parallel to roads and open areas. The same trails will normally be used during the summer.

(5) During the summer months, the open water provides an excellent opportunity to procure all types of fish, both freshwater and saltwater, and freshwater mussels. The mussels can be handpicked off the bottom, while the fish can be netted, speared, clubbed, or caught with a hook and line. After freezeup, fishing is still possible through the ice. Shallow lakes, rivers, or ponds can freeze completely killing off all fish life. Fish tend to congregate in the deepest water possible. A hole should

be cut through the ice at the estimated deepest point. Other good locations are at outlets or where tributaries flow into lakes or ponds. The ice is normally thinner over rapid moving water and at the edges of deep streams or rivers with snowdrifts extending out from the banks. Open water is often marked by a mist or fog formed over the area by vaporizing water. All methods of procuring fish in the summer will work in the winter (figure 18-40).

(6) The ocean shores are rich hunting grounds for edible sea life such as clams, mussels, scallops, snails, limpets, sea urchins, chitons, and sea cucumbers. They can be procured most of the year wherever there is open water. Tidal pools usually contain a great number of both fish and mollusks. The fish can be netted, speared, or hand caught. All sea life can be eaten raw, but cooking usually makes it more palatable (figure 18-41).

b. The plant life of the arctic regions is generally small and stunted due to the effects of permafrost, low mean temperatures, and a short growing season.



Figure 18-39. Swans.

(1) On the barren tundra areas, a wide variety of small edible plants and shrubs exist. During the short summer months on the tundra, Labrador tea, fireweed, coltsfoot, dwarf arctic birch, willow, and numerous other plants and berries can be found. During the winter, roots, rootstalks, and frozen berries can be found beneath the snow. Lichens and mosses are abundant but should be selected carefully as some species are poisonous.

(2) In bog or swamp areas, many types of water sedge, cattail, dwarf birch, and berries are available. During spring and summer, many young shoots from these plants are easily collected.

(3) The wooded areas of the arctic contain a variety of trees (birch, spruce, poplar, aspen, and others). Many berry-producing plants can be found, such as blueberries, cranberries, raspberries, cloud berries, and crow berries. Wild rose hips, Labrador tea, alder, and other shrubs are very abundant. Many wild edible plants are highly nutritious. Greens are particularly rich in carotene (vitamin A). Leafy greens, many berries, and rose hips are all rich in ascorbic acid (vitamin C). Many

roots and rootstalks contain starch and can be used as a potato substitute in stews and soups.

(4) Although there are several types of edible mushrooms, fungi, and puff-balls in the arctic, a person should avoid ingesting them because it is difficult to identify the poisonous and nonpoisonous species. During the growing season, the physical characteristics can change considerably making positive identification even more difficult.

(5) There are many poisonous plants and a few poisonous berries in the arctic. Very few cause death; many will cause extreme nausea, dizziness, abdominal pain, and diarrhea. Contact poisonous plants, such as poison ivy, are not found in the arctic. The more common poisonous plants are shown in figures 18-42 through 18-49.

(6) When selecting edible plants, select young shoots when possible as these will be the most tender. Plants should be eaten raw to obtain the most nutritive value. Some of the more common edible plants are:

(a) Dandelions generally grow with grasses but may be scattered over rather barren areas. Both leaves



Photo by 1365th Photo Squadron (MAC)

Figure 18-40. Winter Fishing.

and roots are edible raw or cooked. The young leaves make good greens; the roots (when roasted) are used as a substitute for coffee.

(b) Black and white spruce are generally the northern most evergreens. These trees have short, stiff needles that grow singularly rather than in clusters like pine needles. The cones are small and have thin scales. Although the buds, needles, and stems have a strong resinous flavor, they provide essential vitamin C by chewing them raw. In spring and early summer, the inner bark can be used for food.

(c) The dwarf arctic birch is a shrub with thin tooth-edged leaves and bark which peels off in sheets. The fresh green leaves and buds are rich in vitamin C. The inner bark may also be eaten.

(d) There are many different species of willow in the arctic. Young tender shoots may be eaten as greens and the bark of the roots is also edible. They have a decidedly sour taste but contain a large amount of vitamin C (figure 18-50).

(7) Lichens are abundant and widespread in the far North and can be used as a source of emergency food.

Many species are edible and rich in starch-like substances, including Iceland moss, peat moss and reindeer lichen. Beard lichen growing on trees has been used as food by Indians. However, some of it contains a bitter acid which causes irritation of the digestive tract. If lichens are boiled, dried, and powdered, this acid is removed and the powder can then be used as flour or made into a thick soup.

18-9. Food on Open Seas. Almost all sea life is not only edible, but is also an excellent source of nutrients essential to humans. The protein is complete because it contains all the essential amino acids, and the fats are similar to those of vegetables. Seafoods are high in minerals and vitamins. The majority of life in the sea (fish, birds, plants, and aquatic animals) is edible.

a. Most seaweeds are edible and are a good source of food, especially for vitamins and minerals. Some seaweeds contain as much as 25 percent protein, while others are composed of over 50 percent carbohydrates. At least 75 different species are used for food by sea-coast residents around the world. For many people, es-



Figure 18-41. Shell Fish.

pecially the Japanese, seaweeds are an essential part of the diet, and the most popular varieties have been successfully farmed for hundreds of years. The high cellulose content may require gradual adaptation because of their laxative quality if they comprise a large part of the diet. As with vegetables, some species are more flavorful than others. Generally, leafy green, brown, or red seaweeds can be washed and eaten raw or dried. The following list of edible seaweeds gives a description of the plant, tells where it may be found, and in many cases, suggests a method of preparation:

(1) Common green seaweeds (figure 18-51), often called sea lettuce (*Ulva lactuca*), are in abundance on both sides of the Pacific and North Atlantic oceans. After washing it in clean water, it can be used as a garden lettuce.

(2) The most common edible brown seaweeds are the sugar wrack, kelp, and Irish moss (figure 18-52).

(a) The young stalks of the sugar wrack are sweet to taste. This seaweed is found on both sides of the Atlantic and on the coasts of China and Japan.

(b) Edible kelp has a short cylindrical stem and thin, wavy olive-green or brown fronds one to several feet in length. It is found in the Atlantic and Pacific oceans, usually below the high-tide line on submerged ledges and rocky bottoms. Kelp should be boiled before eating. It can be mixed with vegetables or soup.

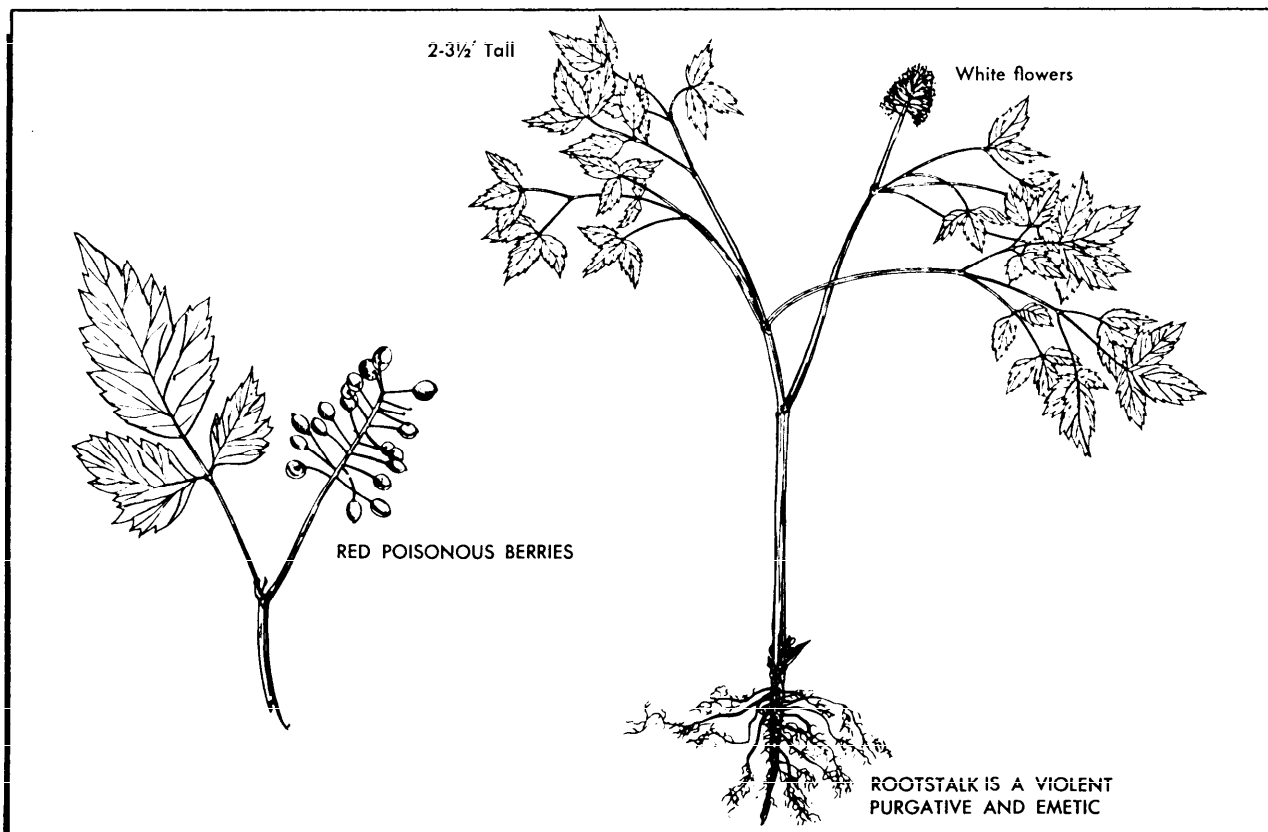

Figure 18-42. Baneberry.

(c) Irish moss, a variety of brown seaweed, is quite edible, and is often sold in market places. It is found on both sides of the Atlantic Ocean and can be identified by its tough, elastic, and leathery texture; however, when dried, it becomes crisp and shrunken. It should be boiled before eating. It can be found at or just below the high-tide line. It is sometimes found cast up on the shore.

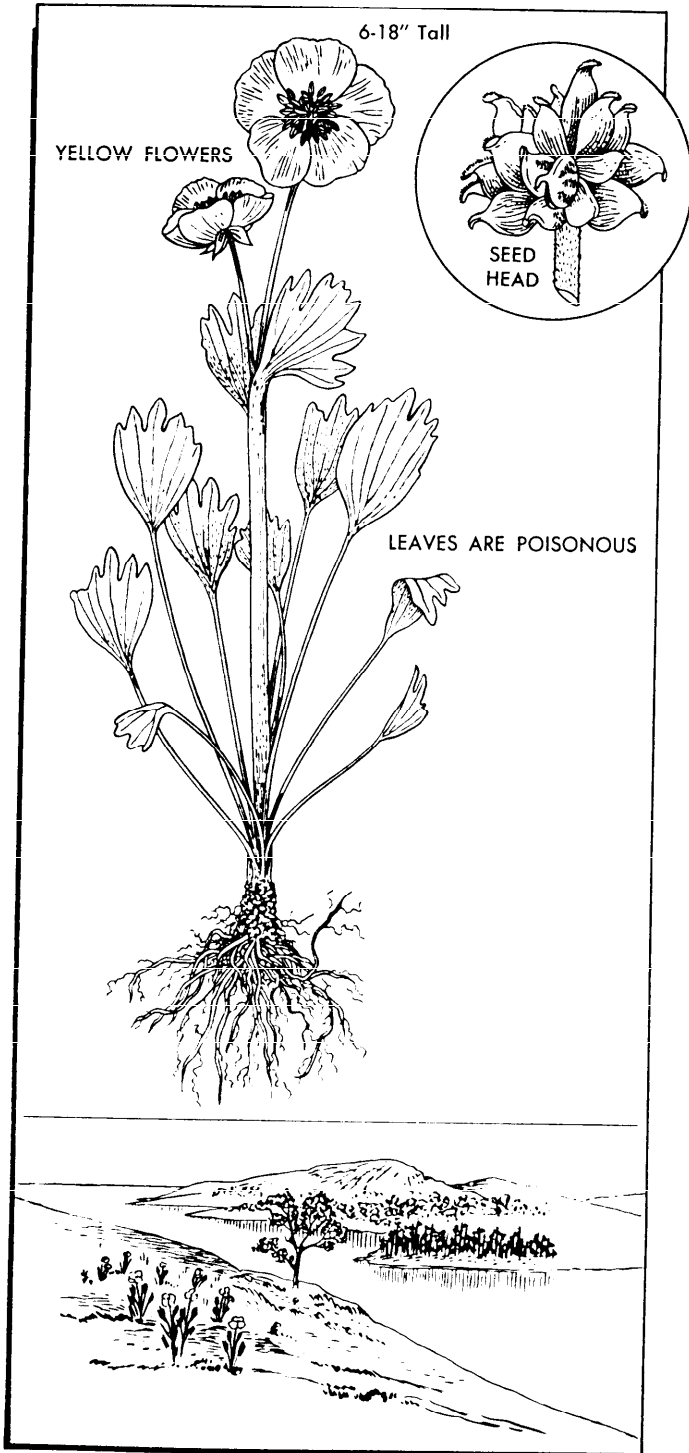

Figure 18-43. Buttercup.

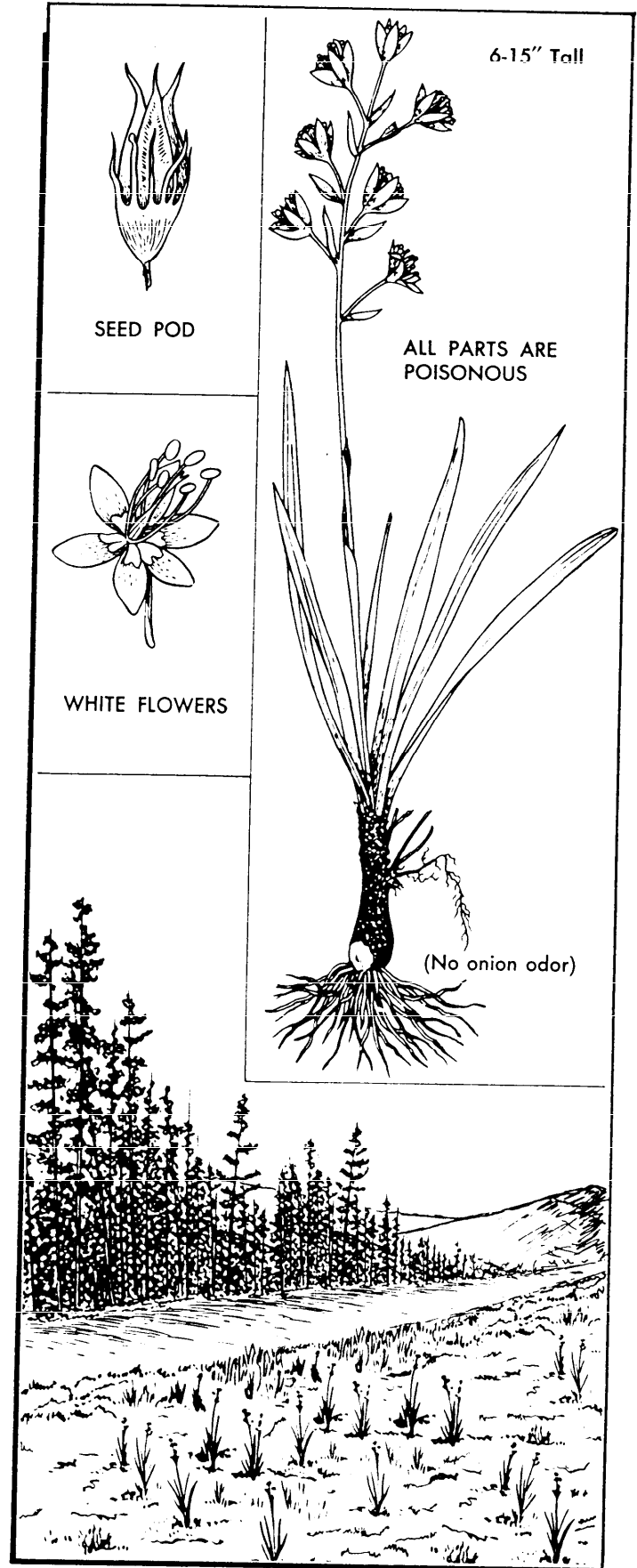

Figure 18-44. Death Camas.

(3) Red seaweeds can usually be identified by their characteristic reddish tint, especially the edible varieties. The most common and edible red seaweeds include the dulse, laver, and other warm-water varieties (figure 18-53).

(a) Dulse has a very short stem which quickly broadens into a thin, broad, fan-shaped expanse which is dark red and divided by several clefts into short, round-tipped lobes. The entire plant is from a few inches to a foot in length. It is found attached to rocks or coarser seaweeds, usually at the low-tide level, on both sides of the Atlantic Ocean and in the Mediterranean. Dulse is leathery in consistency and is sweet to the taste. If dried and rolled, it can be used as a substitute for tobacco.

(b) Laver is usually red, dark purple, or purplish-brown, and has a satiny sheen or filmy luster. Common

to both the Atlantic and Pacific oceans, it has been used as food for centuries. This seaweed is used as a relish, or is cleaned and then boiled gently until tender. It can also be pulverized and added to crushed grains and fried in the form of flatcakes. During World War II, laver was chewed for its thirst-quenching value by New Zealand troops. Laver is usually found on the beach at the low-tide level.

(c) A great variety of red, warm-water seaweed is found in the South Pacific area. This seaweed accounts for a large portion of the native diet. When found on the open sea, bits of floating seaweed may not only be edible but often contains tiny animals that can be used for food. The small fish and crabs can be dislodged by shaking the clump of seaweed over a container.

b. Plankton includes both minute plants and animals that drift about or swim weakly in the ocean. These basic organisms in the marine food chain are generally more common near land since their occurrence depends upon the nutrients dissolved in the water. Plankton can be caught by dragging a net through the water. The taste of the plankton will depend upon the types of organisms predominant in the area. If the population is mostly fish larvae, the plankton will taste like fish. If the population is mostly crab or shellfish larvae, the plankton will taste like crab or shellfish. Plankton contains valuable protein, carbohydrates and fats. Because of its high chiton and cellulose content, however, plankton cannot be immediately digested in large quantities. Therefore, anyone subsisting primarily on a plankton diet must gradually increase the quantities consumed. Most of the planktonic algae (phytoplankton) are smaller than the planktonic animals (zooplankton) and, although edible, are less palatable. Some plankton algae, for example, those dinoflagellates that cause "red tides" and paralytic shellfish poisoning, are toxic to humans.

(1) If a survivor is going to use plankton as a food source, there must be a sufficient supply of freshwater for drinking. Each plankton catch should be examined to remove all stinging tentacles broken from jellyfish or Portuguese man-of-war. The primarily gelatinous species may also be selectively discarded since their tissues are predominately composed of saltwater. When the plankton is found in subtropical waters during the summer months, and the presence of poisonous dinoflagellates is suspected (due to discoloration or high luminescence of the ocean), the edibility test should be applied before eating.

(2) The final precaution which a survivor may wish to take before ingesting plankton is to feel or touch the plankton to check for species that are especially spiny. The catch should be sorted (visually) or dried and crushed before eating if it contains large numbers of these spiny species.

c. If a fishing kit is available, the task of fishing will be made much easier. Small fish will usually gather under the shadow of the raft or in clumps of floating seaweed.

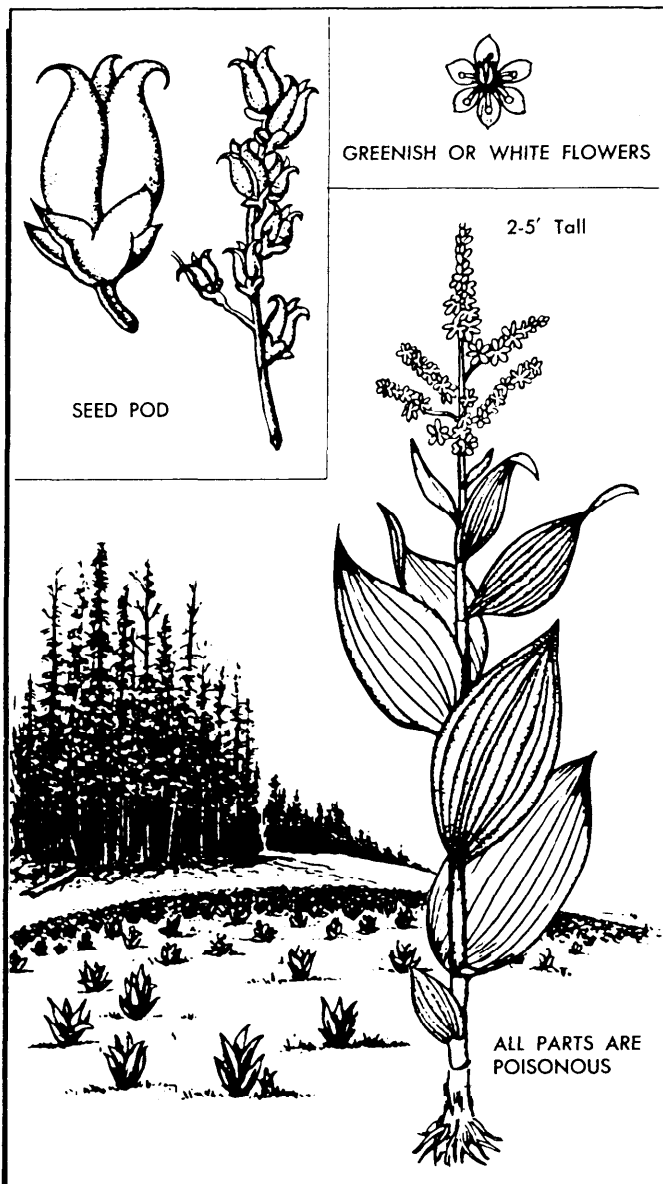

Figure 18-45. False Hellebore.

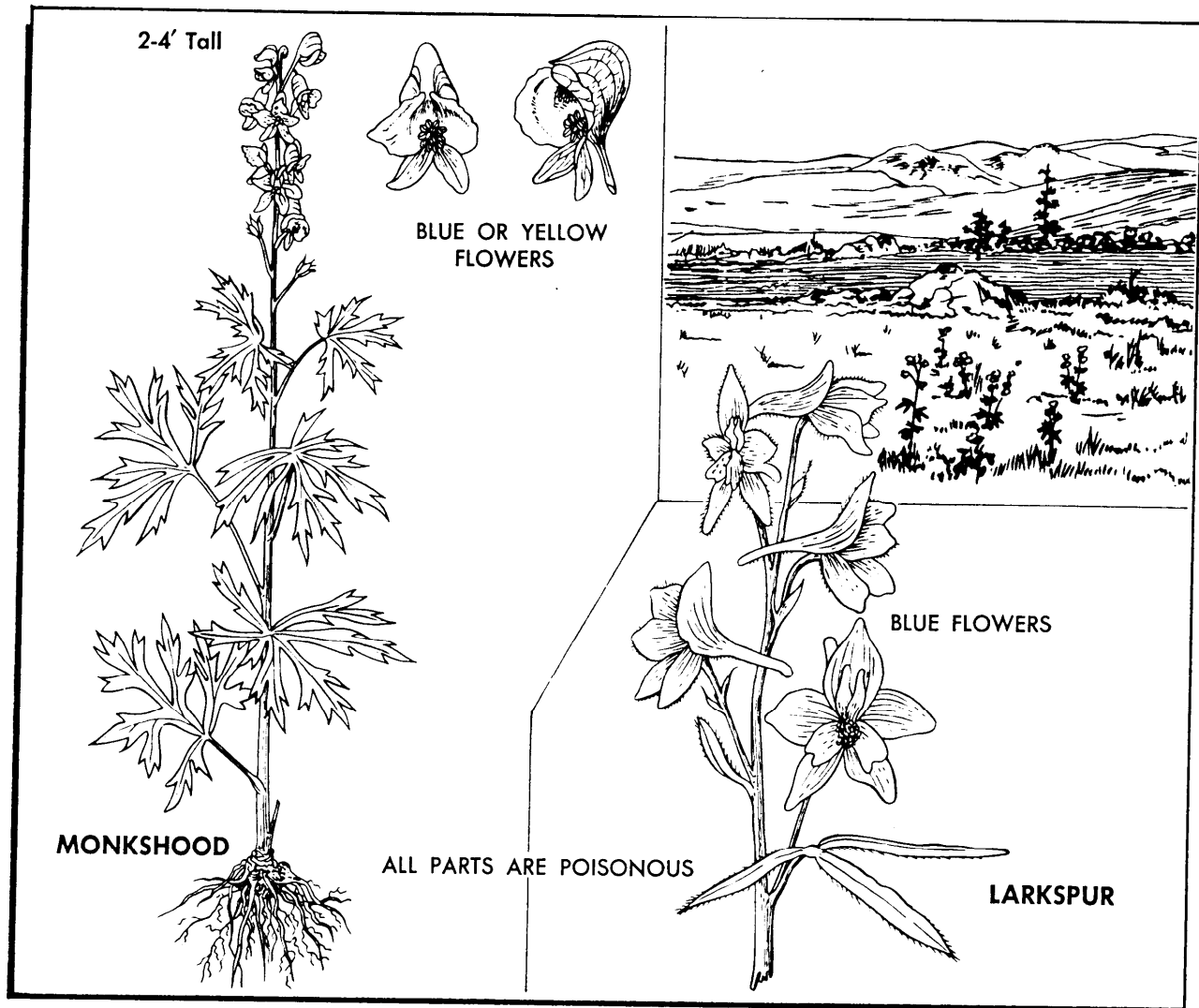

Figure 18-46. Monkshood and Larkspur.

These fish can be eaten or used as bait for larger fish. A net can also be used to procure most all sea life. Light attracts some types of fish. A flashlight or reflected moonlight can be used. It is not advisable to secure fishing lines to the body or the raft because a large fish may pull a person out of the raft or damage the raft. Fish, bait, or bright objects dangling in the water can attract large dangerous fish. All large fish should be killed outside the raft by a blow to the head or by cutting off the head.

d. Sea birds have proven to be a useful food source which may be more easily caught than fish. Survivors have reported capturing birds by using baited hooks, by grabbing, and by shooting. Freshly killed birds should be skinned, rather than plucked, to remove the oil glands. They can be eaten raw or cooked. The gullet contents can be a good food source. The flesh should be eaten or preserved immediately after cleaning. The viscera, along with any other unused parts, make good fish bait.

e. Marine mammals are rarely encountered by a person in the water, although they may be seen from a distance. Any large mammal is capable of inflicting injuries, but unless such mammals are pursued, they will generally avoid people. The killer whale (Orca) is rarely seen and, although large enough to feed on humans, has never been known to do so. Almost all sea mammals are a good source of food but difficult to obtain. The liver, especially that of any arctic or cold-water mammal, should not be eaten because of toxic concentrations of vitamin A.

f. All sea life must be cleaned, cut up, and eaten as soon as possible to avoid spoilage. Any meat left over can be preserved by sun-drying or smoking. The internal parts can be used as bait. If any doubt exists as to the edibility of a seafood, apply the "marine animal edibility test" found in chapter 11.

18-10. Preparing Animal Food. Survivors must know how to use the meat of game and fish to their advantage

and how to do this with the least effort and physical exertion. Many people have died from starvation because they had failed to take full advantage of a game carcass. They abandoned the carcass on the mistaken theory that they could get more game when needed.

a. If the animal is large, the first impulse is usually to pack the meat to camp. In some cases, it might be easier to move the camp to the meat. A procedure often advo-

cated for transporting the kill is to use the skin as a sled for dragging the meat. When the entire animal is dragged, this method may prove satisfactory only on frozen lakes or rivers or over very smooth snow-covered terrain. In rough or brush-covered country, however, it is generally more difficult to use this method, although it will work. Large mountain animals can sometimes be dragged down a snow-filled gully to the base of the mountain. If meat is the only consideration, and the survivors do not care about the condition of the skin, mountain game can sometimes be rolled for long distances. Before transporting a whole animal, it should be gutted and the incision closed. Once the bottom of the hill is reached, almost invariably the method is either to backpack the meat to camp, making several trips if no other survivors are present, or to pack the camp to the animal. Under survival conditions, home is on the back. When the weight of the meat proves excessive and moving the camp is not practical, some of the meat could be eaten at the scene. The heart, liver, and kidneys should be eaten as soon as possible to avoid spoilage.

(1) Under survival conditions, skinning and butchering must be done carefully so that all edible meat can be saved. When the decision is made to discard the skin, a rough job can be done. However, considerations should be given to possible uses of the skin. A square of fresh skin, long enough to reach from the head to the knees, will not weigh much less when it is dried, and is an excellent ground cloth for use under a sleeping bag on frozen ground or snow. The best time to skin and butcher an animal is immediately after the kill. However, if an animal is killed late in the day, it can be gutted immediately and the other work done the next morning. An effort to keep the carcass secure from predators should be made.

(2) When preparing meat under survival conditions, all edible fat should be saved. This is especially important in cold climates, as the diet may consist almost entirely of lean meat. Fat must be eaten in order to provide a complete diet. Rabbits lack fat, and the fact that a person will die after an extended diet consisting only of rabbit meat indicates the importance of fat in a primitive diet. The same is true of birds, such as the ptarmigan.

(3) Birds should be handled in the same manner as other animals. They should be cleaned after killing and protected from flies. Birds, with the exception of sea birds, should be plucked and cooked with the skin on. Carrion-eating birds, such as vultures, must be boiled for at least 20 minutes to kill parasites before further cooking and eating. Fish-eating birds have a strong, fish-oil flavor. This may be lessened by baking them in mud or by skinning them before cooking.

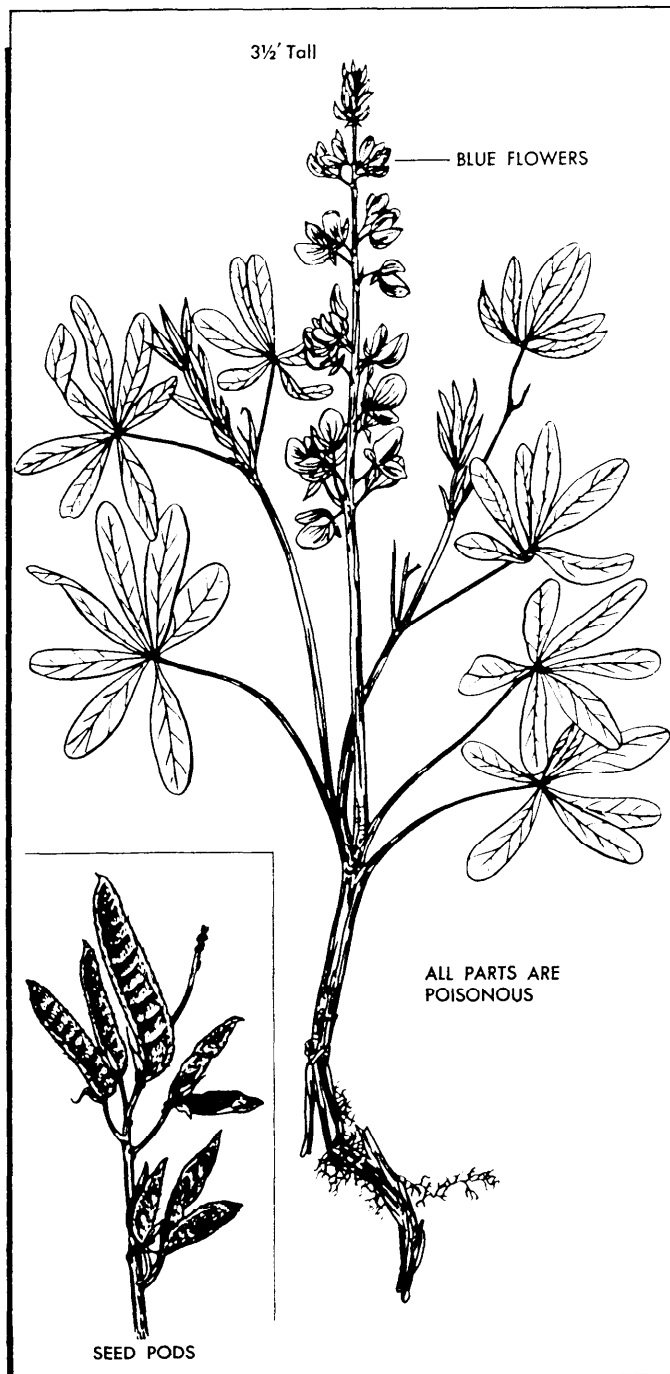

Figure 18-47. Lupine.

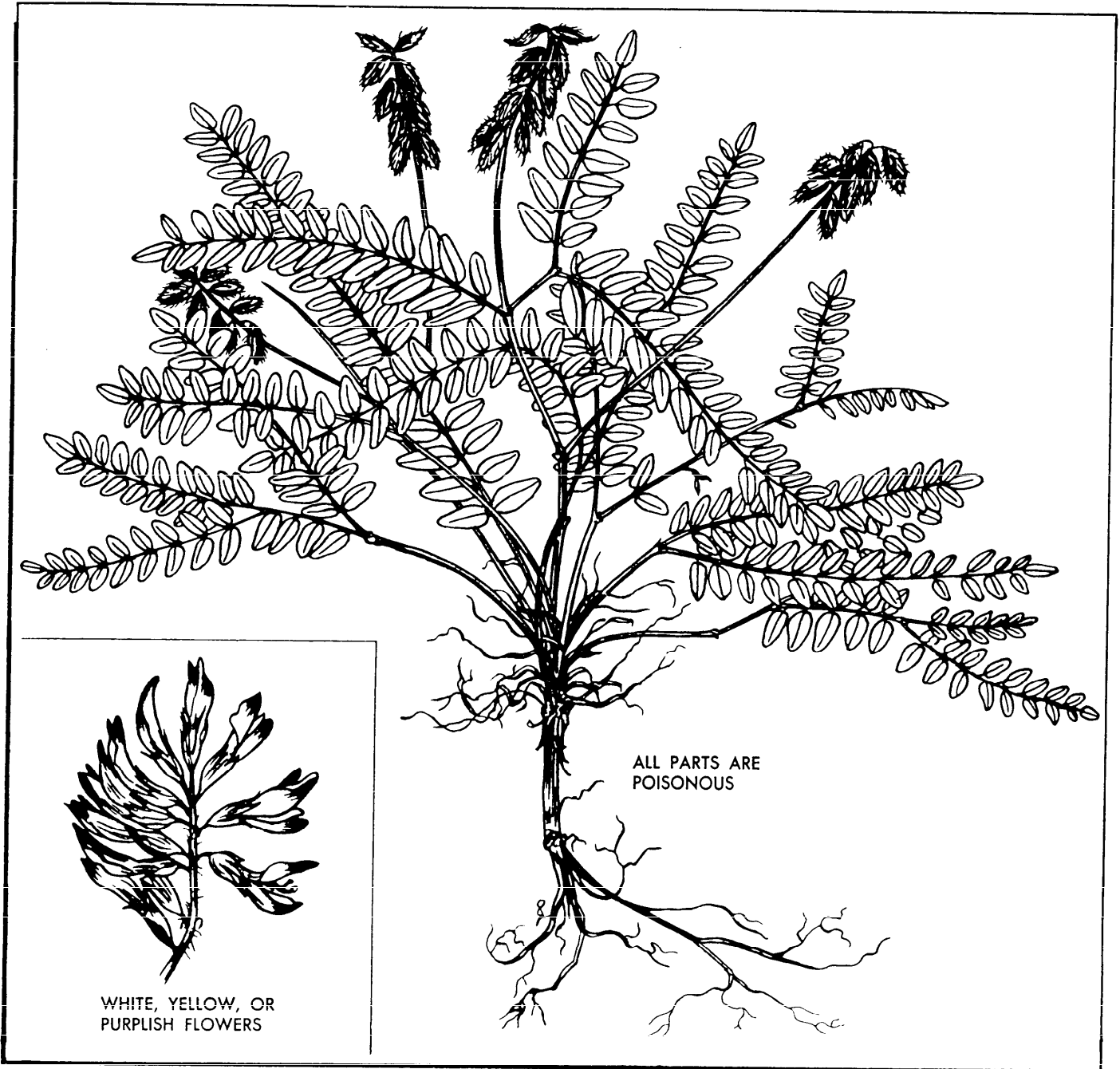

Figure 18-48. Vetch and Locoweed.

b. There are two general ways to skin animals depending upon the size: the big game method, or the glove skinning method.

(1) Survivors should use the big game method when skinning and butchering large game.

(a) The first step in skinning is to turn the animal on its back and with a sharp knife, cut through the skin on a straight line from the tail bone to a point under its neck as illustrated in figure 18-54. In making this cut, pass around the anus and, with great care, press the skin open until the first two fingers can be inserted between

the skin and the thin membrane enclosing the entrails. When the fingers can be forced forward, place the blade of the knife between the fingers, blade up, with knife held firmly. While forcing the fingers forward, palm upward, follow with the knife blade, cutting the skin but not cutting the membrane.

(b) If the animal is a male, cut the skin parallel to, but not touching the penis. If the tube leading from the bladder is accidentally cut, a messy job and unclean meat will result. If the gall or urine bladders are broken, washing will help clean the meat. Otherwise, it is best

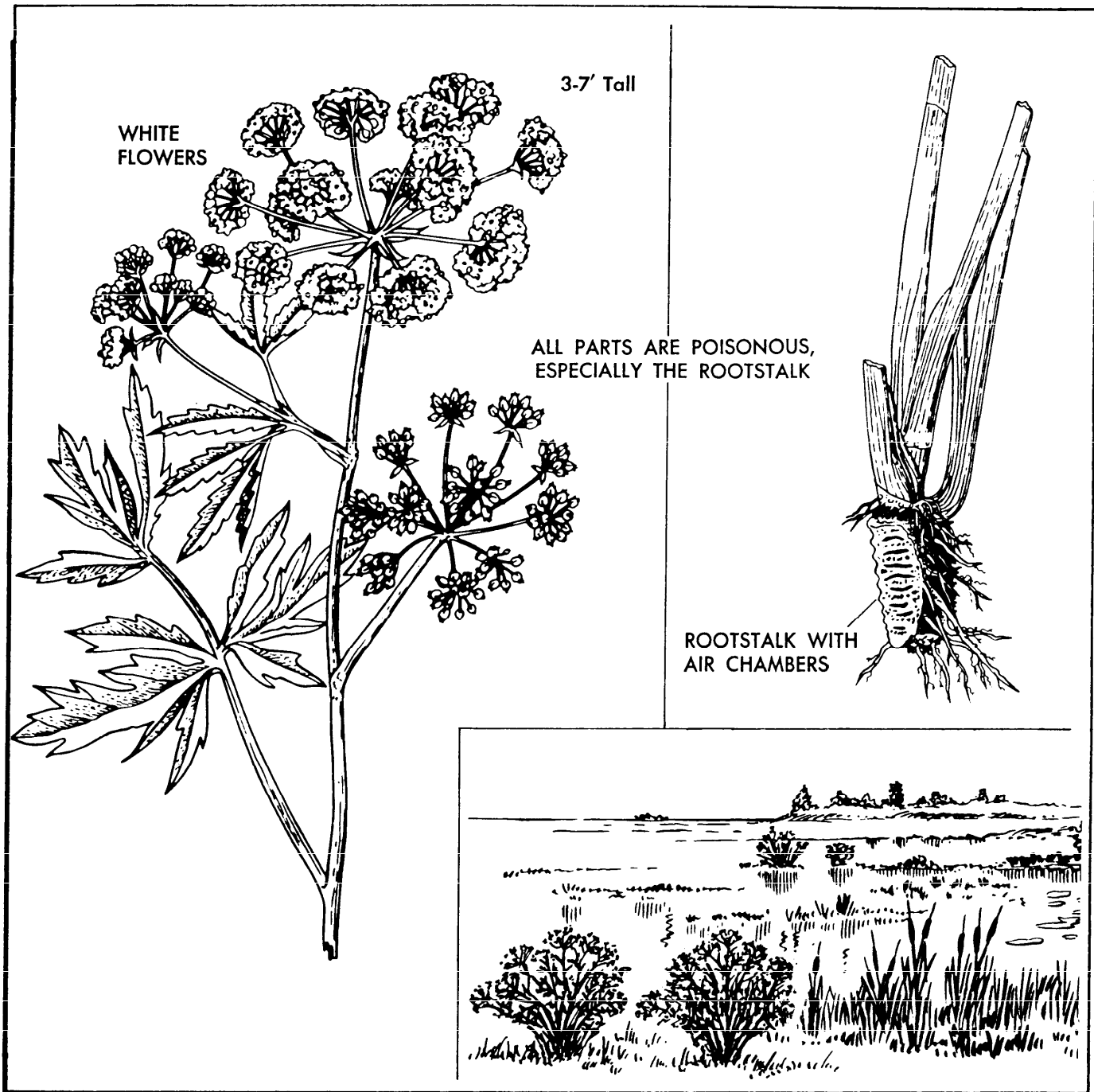

Figure 18-49. Water Hemlock.

not to wash the meat but to allow it to form a protective glaze.

(c) On reaching the ribs, it is no longer possible to force the fingers forward, because the skin adheres more strongly to flesh and bone. Furthermore, care is no longer necessary. The cut to point C can be quickly completed by alternately forcing the knife under the skin and lifting it. With the central cut completed, make side cuts consisting of incisions through the skin, running from the central cut (A-C) up the inside of each leg to the

knee and hock joints. Then make cuts around the front legs just above the knees and around the hind legs above the hocks. Make the final cross cut at point C, and then cut completely around the neck and in back of the ears. Now is the time to begin skinning.

(d) On a small or medium-sized animal, one person can skin on each side. The easiest method is to begin at the corners where the cuts meet. When the animal is large, three people can skin at the same time. However, one should remember that when it is getting

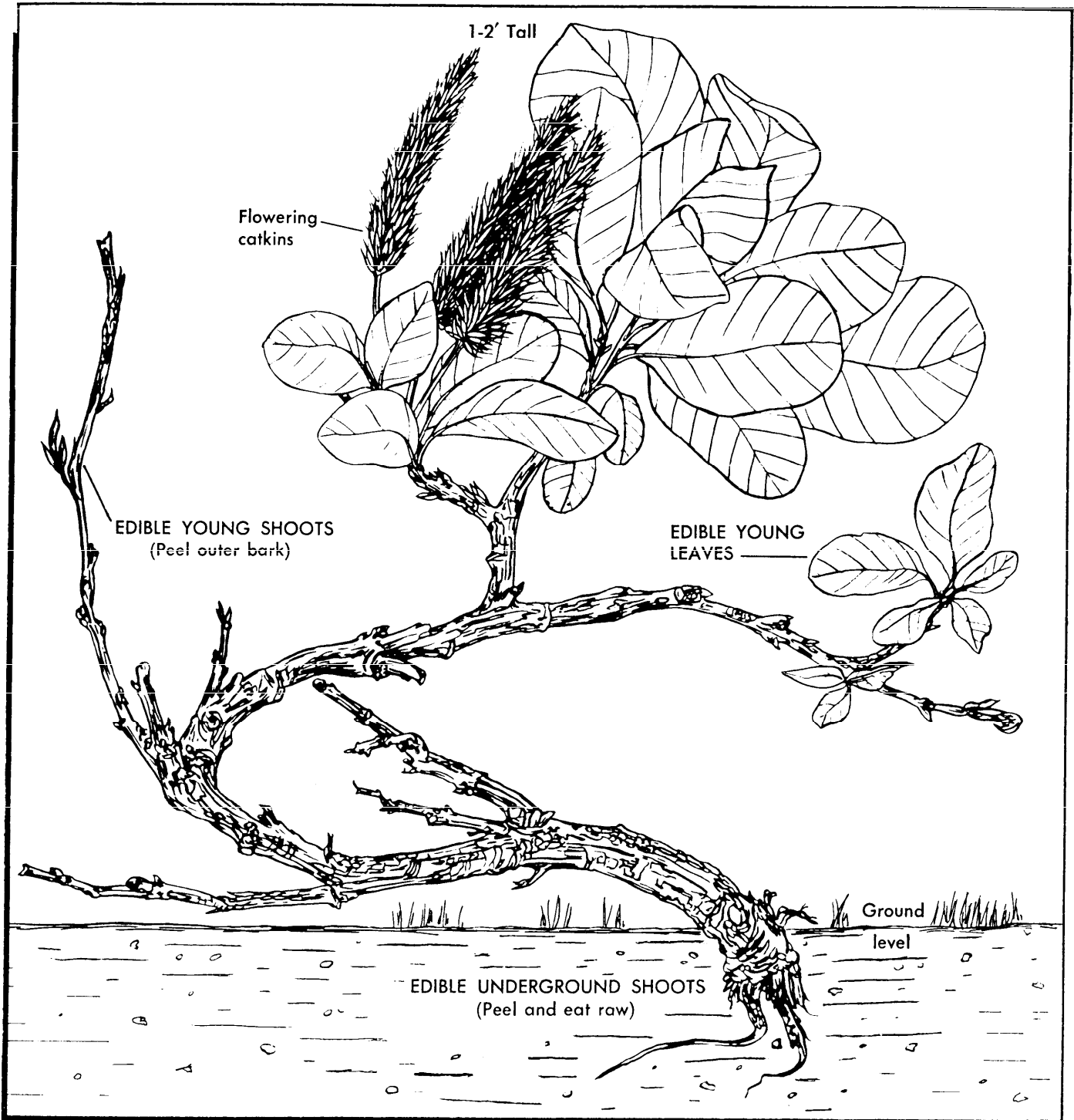

Figure 18-50. Arctic Willow.

dark and hands are clumsy because of the cold, a sharp skinning knife can make a deep wound. After skinning down the animal's side as far as possible, roll the carcass on its side to skin the back. Then spread out the loose skin to prevent the meat from touching the ground and turn the animal on the skinned side. Follow the same procedure on the opposite side until the skin is free.

(e) In opening the membrane which encloses the

entrails, follow the same procedure used in cutting the skin by using the fingers of one hand as a guard for the knife and separating the intestines from membrane. This thin membrane along the ribs and sides can be cut away in order to see better. Be careful to avoid cutting the intestines or bladder. The large intestine passes through an aperture in the pelvis. This tube must be separated from the bone surrounding it with a knife. Tie

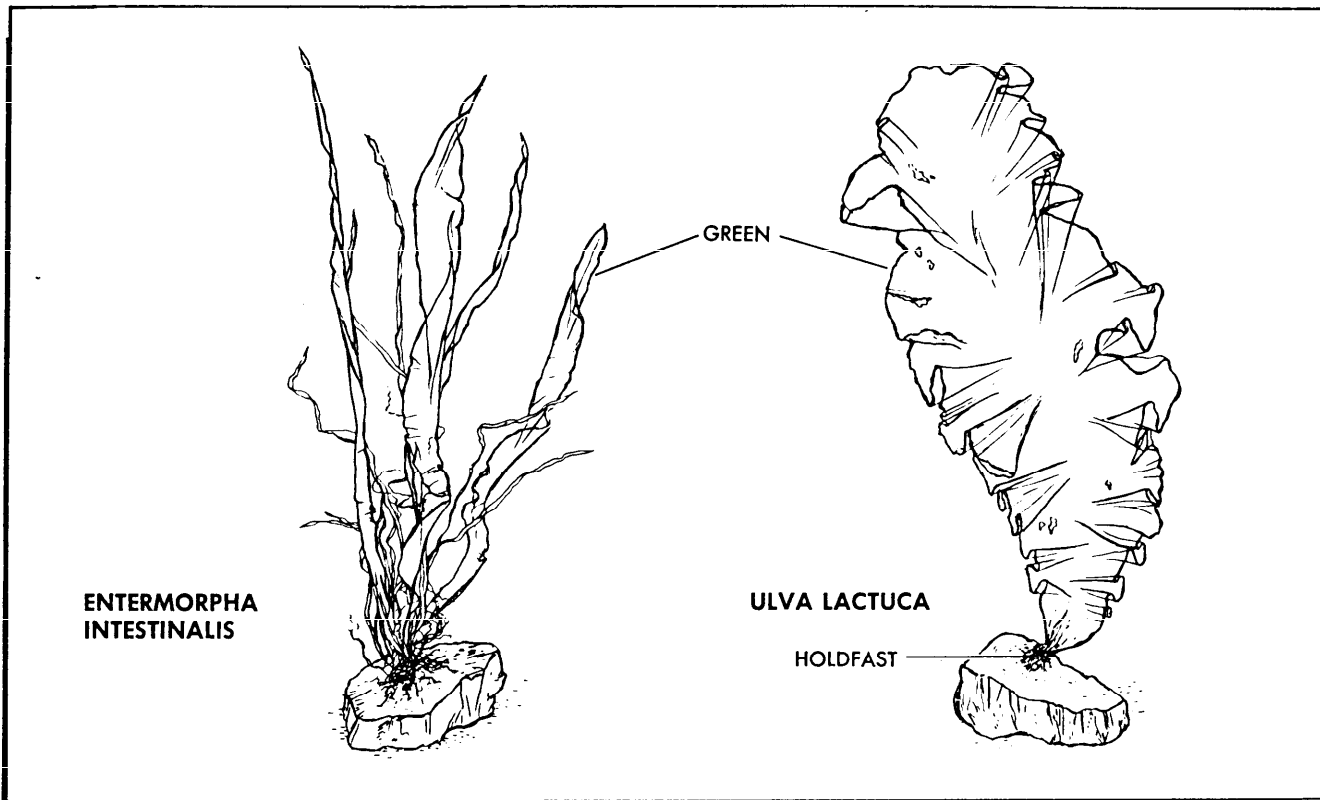

Figure 18-51. Edible Green Seaweeds.

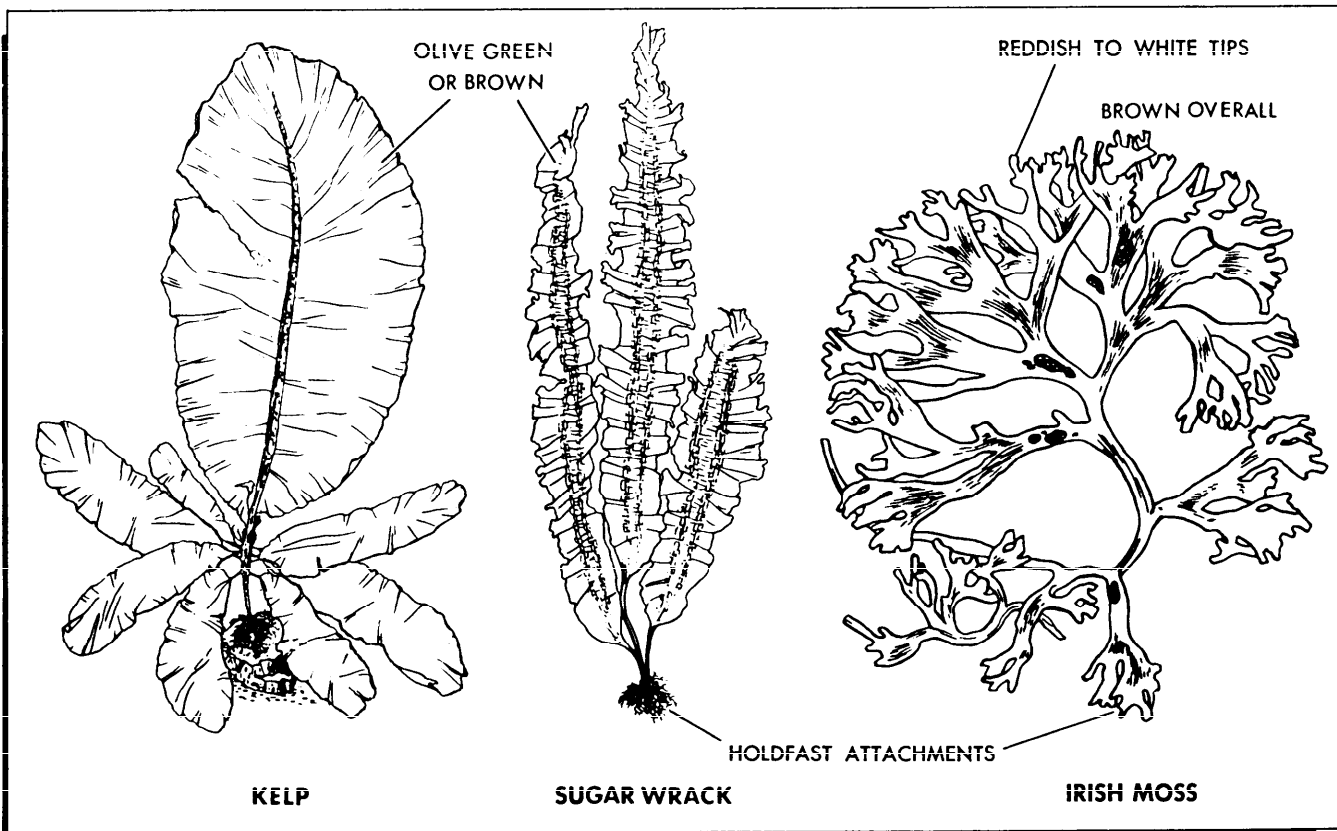

Figure 18-52. Edible Brown Seaweeds.

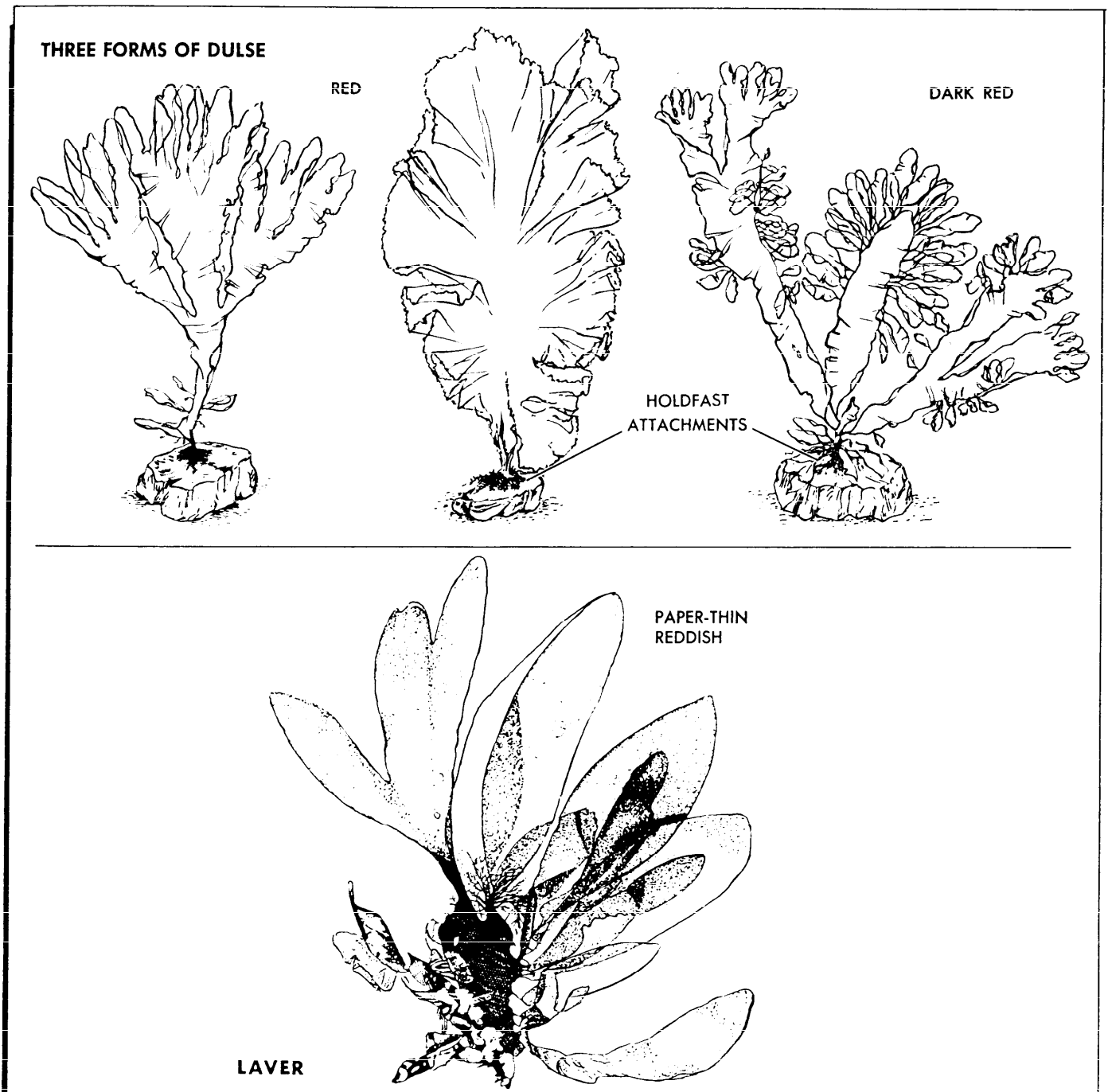

Figure 18-53. Edible Red Seaweeds.

a knot in the bladder tube to prevent the escape of urine. With these steps completed, the entrails can be easily disengaged from the back and removed from the carcass. Another method of gutting or field dressing is shown in figure 18-55. After gutting is completed, it may be advisable to hang the animal. Figure 18-56 shows two methods. (NOTE: If it is hot, gut the animal before skinning it.)

(f) The intestines of a well-conditioned animal are covered with a lace-like layer of fat which can be lifted off and placed on nearby bushes to dry for later

use. The gall bladder which is attached to the liver of some animals should be carefully removed. If it should happen to rupture, the bile will taint anything it touches. Be sure to clean the knife if necessary. The kidneys are imbedded in the back, forward of the pelvis, and are covered with fat. Running forward from the kidneys on each side of the backbone are two long strips of chop-meat or muscle called tenderloin or backstrap. Eat this after the liver, heart, and kidneys as it is usually very tender. Edible meat can also be removed from the head, brisket, ribs, backbone, and pelvis.

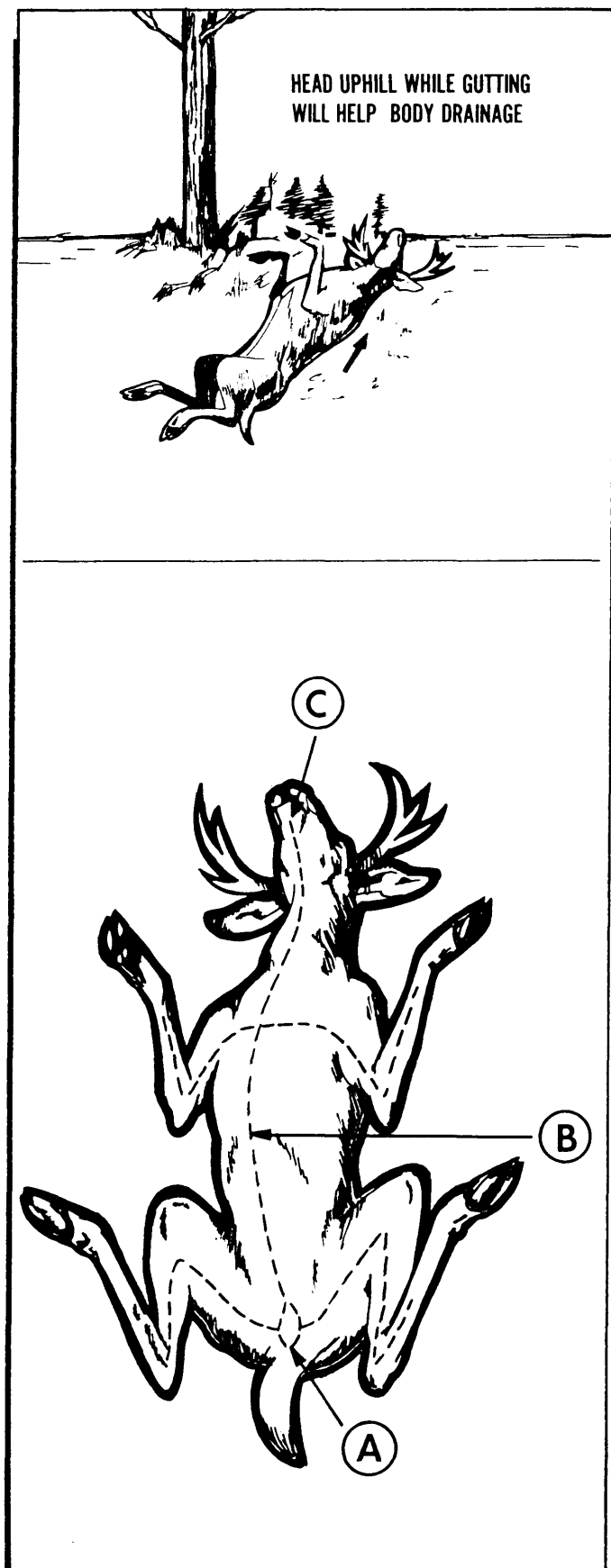

Figure 18-54. Big Game Skinning.

(g) Large animals should be quartered. To do this, cut down between the first and second rib and then sever the backbone with an axe or machete. Cut through the brisket of the front half and then chop lengthwise through the backbone to produce the front quarters. On the rear half, cut through the pelvic bone and lengthwise through the backbone. To make the load lighter and easier to transport, a knife could be used to bone the animal, thereby eliminating the weight of the bones. Butchering is the final step and is simplified for survival purposes. The main purpose is to cut the meat in manageable size portions (figure 18-57).

(2) Glove skinning is usually performed on small game (figure 18-58).

(a) The initial cuts are made down the insides of the back legs. The skin is then peeled back so that the hindquarters are bare and the tail is severed. To remove the remaining skin, pull it down over the body in much the same way a pullover sweater is removed. The head and front feet are severed to remove the skin from the body. For one-cut skinning of small game, cut across the lower back and insert two fingers under each side of the slit. By pulling quickly in opposite directions, the hide will be easily removed (figure 18-59).

(b) To remove the internal organs, a cut should be made into the abdominal cavity without puncturing the organs. This cut must run from the anus to the neck. There are muscles which connect the internal organs to the trunk and they must be severed to allow the viscera to be removed. A rabbit may be gutted by using a knifeless method with no mess and little time lost. Squeeze the entrails toward the rear resulting in a tight bulging abdomen. Raise the rabbit over the head and sling it down hard striking the forearms against the thighs. The momentum will expel the entrails through a tear in the vent (figure 18-60). Save the internal organs such as heart, liver, and kidneys, as they are nutritious. The liver should be checked for any white blotches and discarded if affected as these indicate tularemia (also known as rabbit fever). The disease is transmitted by rodents but also infects humans.

c. Cold-blooded animals are generally easy to clean and prepare.

(1) Snakes and lizards are very similar in taste and they have similar skin. Like the mammals, the skin and viscera should be removed. The easiest way to do this is to sever the head and (or) legs. In the case of a lizard, peel back enough skin so that it may be grasped securely and simply pull it down the length of the body turning the skin inside out as it goes. If the skin does not come away easily, a cut down the length of the animal can be made. This will allow the skin to part from the body more easily. The entrails are then removed and the animal is ready to cook.

(2) Except for the larger amphibians such as the bullfrog, the hind legs are the largest portion of the animal worth saving. To remove the hindquarters, sim-

ply cut through the backbone with a knife, leaving the abdomen and upper body. Pull the skin from the legs and they are ready to cook. With the bullfrogs and larger amphibians, the whole body can be eaten. The head, the skin, and viscera should be removed and discarded (use as bait to catch something else).

d. Most fish need little preparation before they are eaten. Scaling the fish before cooking is not necessary. A cut from the anus to the gills will expose the internal organs which should be removed. The gills should also be removed before cooking. The black line along the

inside of the backbone is the kidney and should be removed by running a thumbnail from the tail to the head. There is some meat on the head and should not be discarded. See figure 18-61 for one method of filleting a fish.

e. All birds have feathers which can be removed in two ways: by plucking or pulling out the feathers, and by skinning. The gizzard, heart, and liver should be retained. The gizzard should be split open as it contains partially digested food and stones which must be discarded before being eaten.

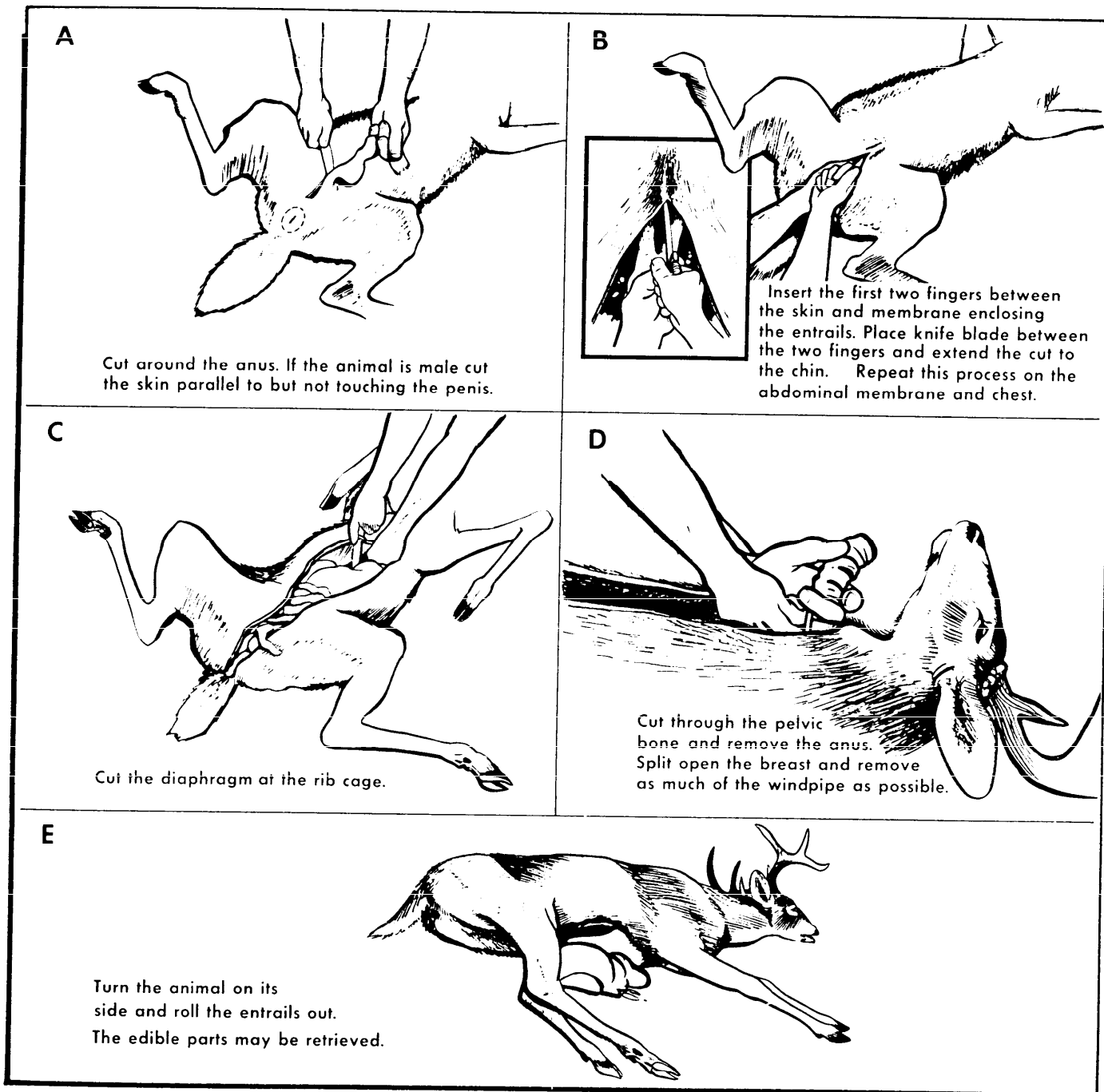

Figure 18-55. Field Dressing.

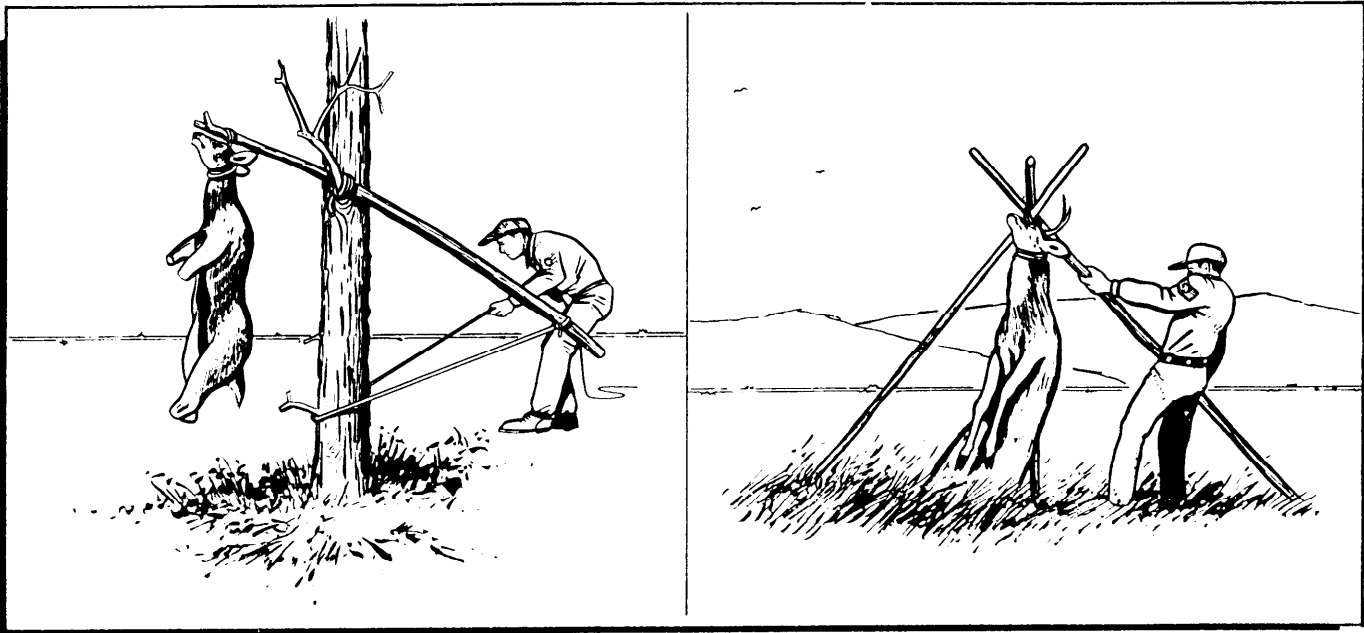

Figure 18-56. Hanging Game.

f. Insects are an excellent food source and they require little or no preparation. The main point to remember is to remove all hard portions such as the hind legs of a grasshopper and the hard wing covers of beetles. The rest is edible.

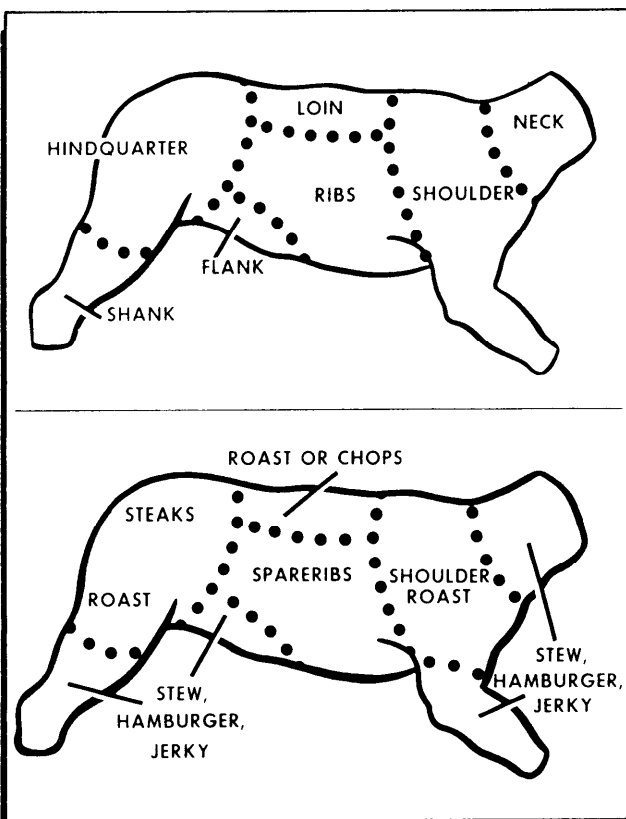

Figure 18-57. Butchering.

18-11. Cooking. All wild game, large insects (grasshoppers), freshwater fish, clams, mussels, snails, and crawfish must be thoroughly cooked to kill internal parasites. Mussels and large snails may have to be minced to make them tender.

a. Boiling is the most nutritious, simplest, and safest method of cooking (figure 18-62). Numerous containers can be used for boiling; for example, a metal container suspended above, or set beside, a heat source to boil foods. Green bamboo makes an excellent cooking container. Stone boiling is a method of boiling using super-heated rocks and a container that holds water but cannot be suspended over an open flame. Example of containers are survival kit containers, flying helmet, a hole in the ground lined with waterproof material, or a hollow log. The container is filled with food and water and then heated with super-hot stones until the water boils. Stones from a stream or damp area should not be used. The moisture in the stones may turn to steam and cause the stone to explode while the stones are being heated in the fire. The container should be covered and new stones added as the water stops boiling. The rocks can be removed with the aid of a wire secured to the rock before being put into the container or two sticks used in a chopstick fashion.

b. Baking is a good method of cooking as it is slow and is usually done by putting food into a container and cooking it slowly. Baking is often used with various types of ovens. Foods may be wrapped in wet leaves (figure 18-63) (avoid using a type of plant that will give an unpleasant flavor to what is being cooked), placed inside a metal container, or they may be packed with mud or clay and placed directly on the coals. Fish and

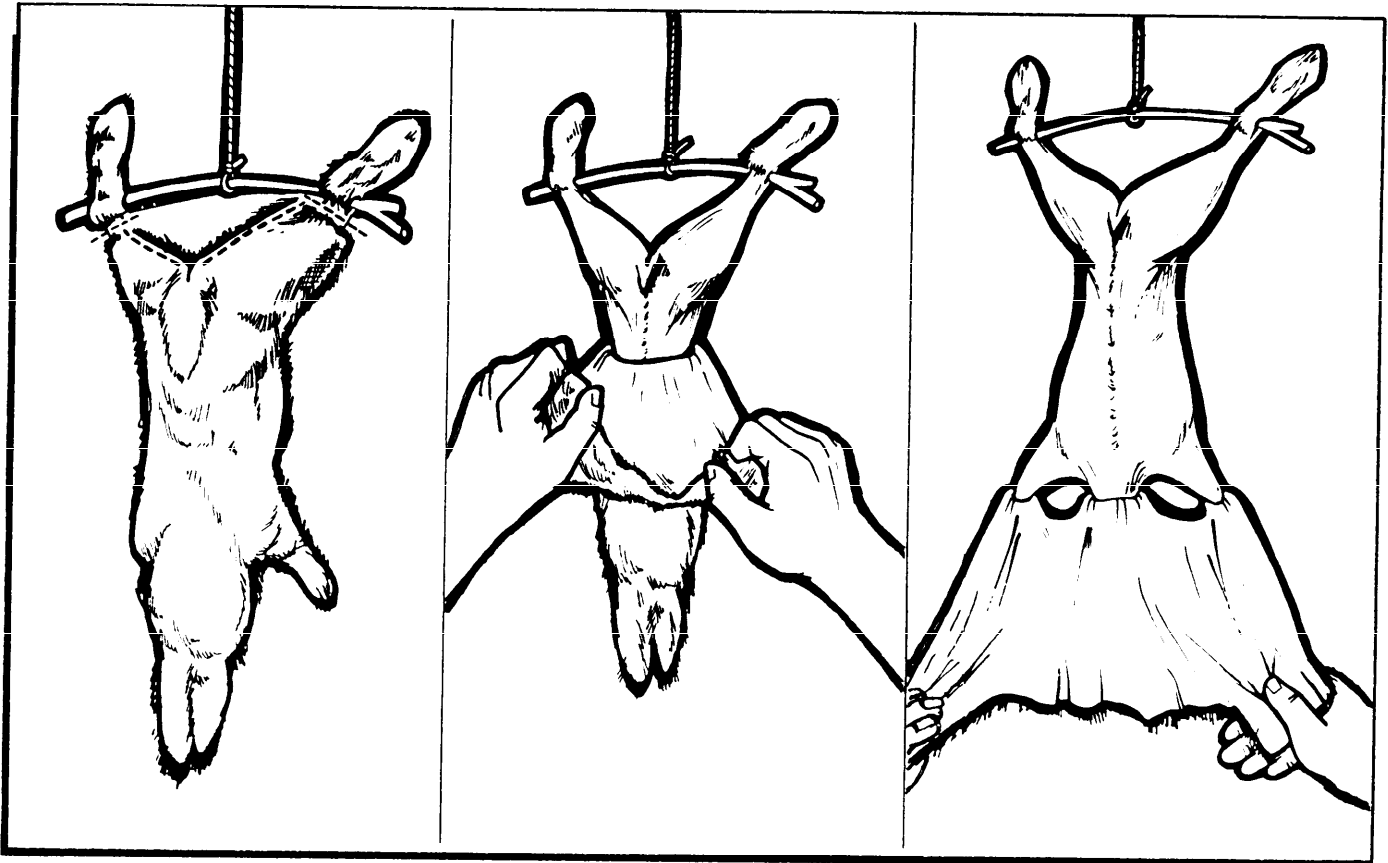

Figure 18-58. Glove Skinning.

birds packed in mud and baked must not be skinned because the scales, skin, or feathers will come off the animal when the mud or clay is removed. Clambake-style baking is done by heating a number of stones in a fire and allowing the fire to burn down to coals. A layer of wet seaweed or leaves is then placed over the hot rocks. Food such as mussels and clams in their shells are placed on the wet seaweed and (or) leaves (figure 18-64). More wet seaweed and (or) leaves and soil is used as a cover. When thoroughly steamed in their own juices, clam, oyster, and mussel shells will open and may be eaten without further preparation.

c. Any type of food can be cooked in the ground in a rock oven (figure 18-65). First, a hole is dug about 2 feet deep and 2 or 3 feet square, depending on the amount of food to be cooked. The sides and bottom are then lined with rock. Next, procure several green trees about 6 inches in diameter and long enough to bridge the hole. Firewood and grass or leaves for insulation should also be gathered. A fire is started in the hole. Two or three green trees are placed over the hole and several rocks are placed on the trees. The fire must be maintained until the green trees burn through. This indicates the fire has burned long enough to thoroughly heat the rocks and the oven is ready. The fallen rocks, fire, and ash are removed from the hole and a thin layer of dirt is spread

over the bottom. The insulating material (grass, leaves, moss, etc.) is placed over the soil, then the food more insulating material on top and around the food, another thin layer of soil, and the extra hot rocks are placed on top. The hole is then filled with soil up to ground level.

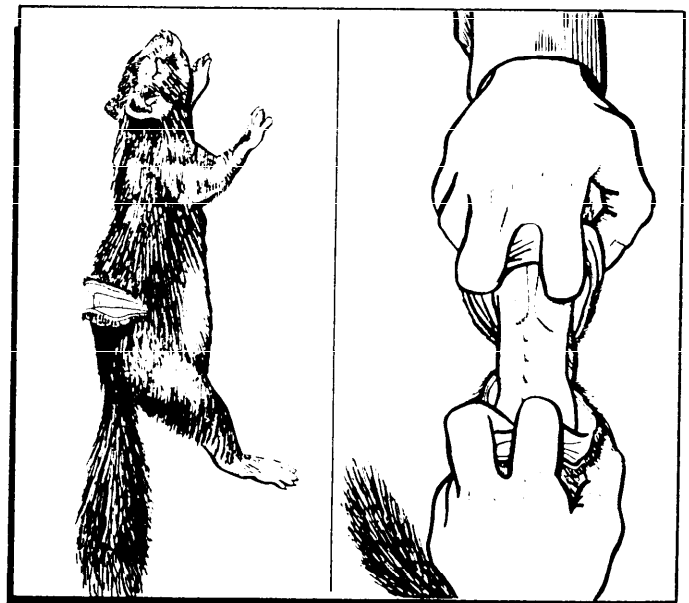

Figure 18-59. Small Animal Skinning.

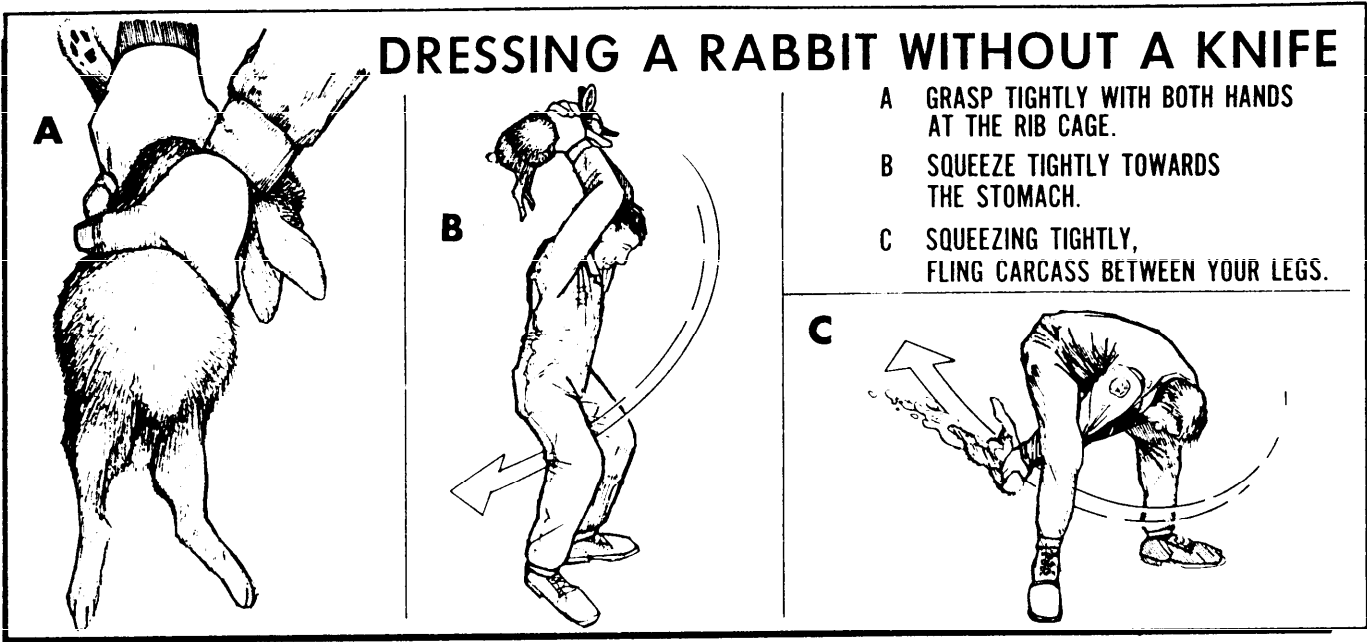

Figure 18-60. Dressing a Rabbit Without a Knife.

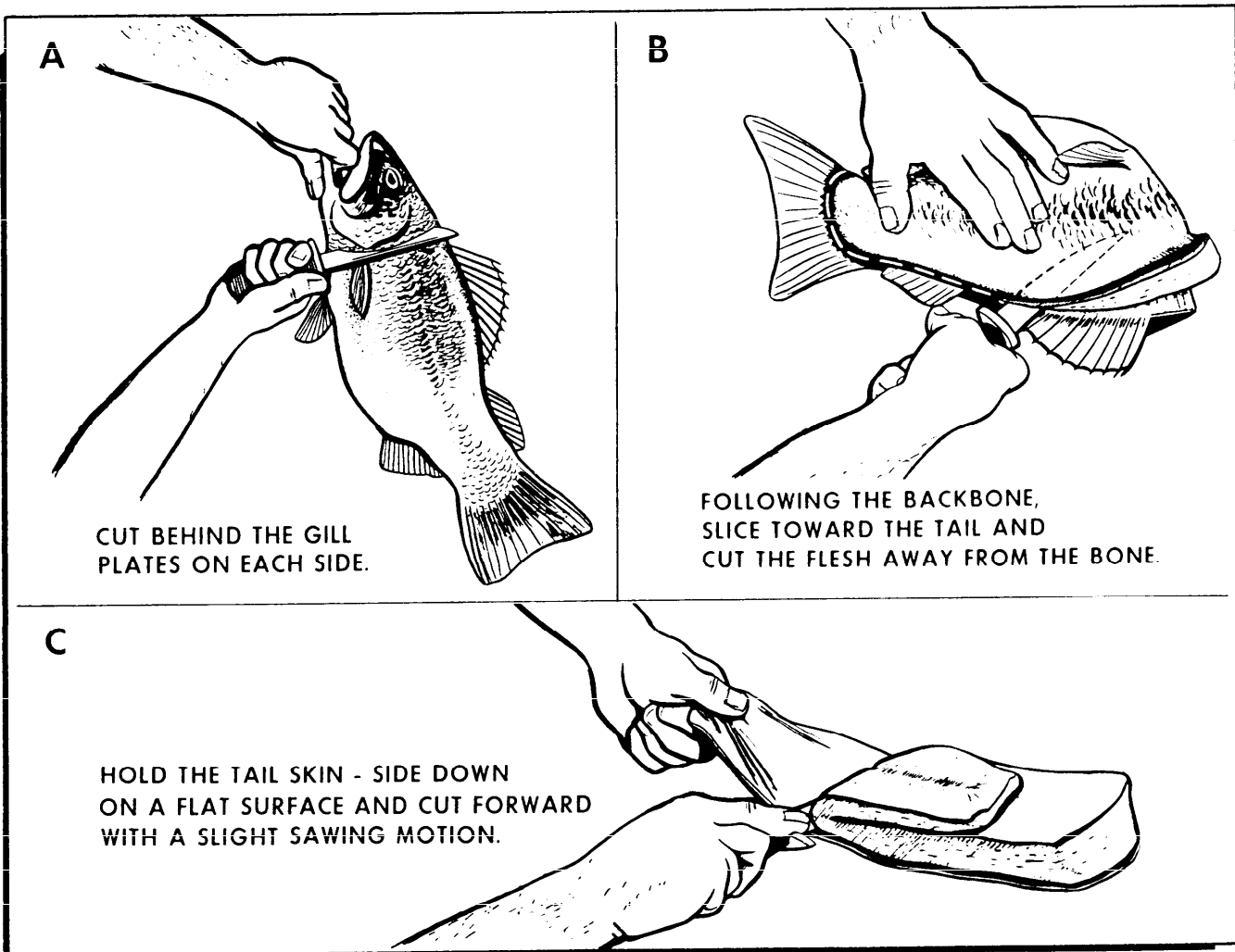

Figure 18-61. Filleting a Fish.



Figure 18-62. Boiling.

Small pieces of meat (steaks, chops, etc.) cook in 1½ to 2 hours and large pieces take 5 to 6 hours.

d. Roasting is less desirable as it involves exposing the food to direct heat which quickly destroys the nutritional properties (figure 18-66). Putting a piece of meat on a stick and holding it over the fire is considered roasting.

e. Broiling is the quickest way to prepare fish. A rock broiler may be made by placing a layer of small stones on top of hot coals, and laying the fish on the top. Scaling the fish before cooking is not necessary, and small fish need not be cleaned. Cooked in this manner, fish have a moist and delicious flavor. Crabs and lobsters may also be placed on the stones and broiled.

f. Meat may be cooked by laying it on a flat board or stone (planking) which is propped up close to the fire (figure 18-67). The meat will have to be turned over at least once to allow thorough cooking. The cooking time depends on how close the meat is to the fire.

g. Frying is by far the least favorable method of preparing food. It tends to make the meat tough because most all of the natural juices are cooked out of the meat. Some of the nutritional value of the meat will also be destroyed. Frying can be done on any nonporous surface which can be heated. Examples are unpainted aircraft parts, turtle shells, large seashells, flat rocks, and some survival kit parts.

18-12. Preparing Food in Enemy Areas. The problem of preparing food in a hostile area becomes acute when a fire, even a small cooking fire, can bring about capture. After finding food in a hostile area, the problem of preparing the food in a manner which will not compromise the survivors presence must be resolved. Of course, it



Figure 18-63. Baking.



Figure 18-64. Clam Baking.



Figure 18-65. Rock Oven.



Figure 18-66. Broiling and Roasting.

would be simple to state that the best solution would be to eat the food without cooking it.

a. In some respects, this would be a more reasonable solution than it might initially seem to be. From the standpoint of palatability, it is mostly a matter of adjusting the "frame of mind." Animal foods are recognized as being palatable when cooked to a very minor degree. The need for food cannot be ignored and the situation may demand that it be eaten partially cooked or even uncooked.

b. With regard to the health considerations involved, many of the reasons for cooking are recognized as a means of destroying organisms that may be present in the food and can cause sickness or ill effects if they enter into the body. Under survival conditions in a hostile area, one may be forced to forego thorough cooking and accept the risk involved until their return to friendly forces where professional treatment is available.

c. Assuming that there will have to be a way to prepare food under hostile conditions, a survivor should be aware of some of the ways in order to achieve some degree of safety, and at the same time, improve palatability. Parasites and other organisms living in the flesh of the animals depend upon the body temperature of the animals, the moisture within the flesh of the animals, and other factors to support their life. Any action that modifies these conditions (for example, freezing or thorough drying of the meat) and kills some parasites may improve the palatability.

d. If cooking is considered necessary, use extreme care in selecting the site for a fire and ensure that security considerations are favorable. The food should be prepared in very small quantities in order to keep the size of the fire as small as possible. The use of the "Dakota Hole" configuration is more appropriate for cooking food during a tactical situation (figure 16-14).

18-13. Preserving Food. Finding natural foods is an uncertain aspect of survival. The survivor must make the best use of the available food. Food, especially meat, has a tendency to spoil within a short period of time unless it is preserved. There are many ways to preserve food; some of the most common are cooking, refrigeration, freezing, and dehydration.



Figure 18-67. Planking.

a. Cooking will slow down the decomposition of food but will not eliminate it. This is because many bacteria are present which work to break it down. Cooking methods which are the best for immediate consumption, such as boiling, are the least effective for preserving food. Food should be recooked every day until all is consumed.

b. Cooling is an effective method of storing food for short periods of time. Heat tends to accelerate the decomposition process where cooling retards decomposition. The colder food becomes, the less the likelihood of deterioration until freezing eliminates decomposition. Cooling devices available to a survivor are:

(1) Food items buried in snow will maintain a temperature of approximately 32°F.

(2) Food wrapped in waterproof material and placed in streams will remain cool in summer months. Care should be taken to ensure food is secured.

(3) Earth, below the surface, particularly in shady areas or along streams, remains cooler than the surface. A hole may be dug, lined with grass, and covered to form an effective cool storage area much the same as a root cellar.

(4) When water evaporates, it tends to cool down the surrounding area. Using this fact, articles of food may be wrapped in an absorbent material such as cotton or burlap and rewetted as the water evaporates.

c. Once food is frozen, it will not decompose. Food should be frozen in meal-sized portions so refreezing is avoided.

d. Drying removes all moisture and preserves the food. Drying is done by sunning, smoking, or burying it in hot sand.

(1) For sun-drying, the food should be sliced very thin and placed in direct sunlight. Meat should be cut across the grain to improve tenderness and decrease drying time. If salt is available, it should be added to improve flavor and accelerate the drying process (figure 18-68).

(2) Smoking is a process done through the use of nonresinous wood such as willow or aspen and is used to produce smoke which adds flavor and dries the meat. A smoke rack is also necessary to contain the smoke (figure 18-69). The following are the procedures for drying meat using smoke:

(a) Cut meat very thin and across the grain. If the meat is warm and difficult to slice thin, cut the meat in 1 or 2-inch cubes and beat it thin with a clean wooden mallet (improvised).

(b) Remove fat.

(c) Hang the meat on a rack so each piece is separate.

(d) Elevate meat no less than 2 feet above coals.



Figure 18-68. Sun-Drying.

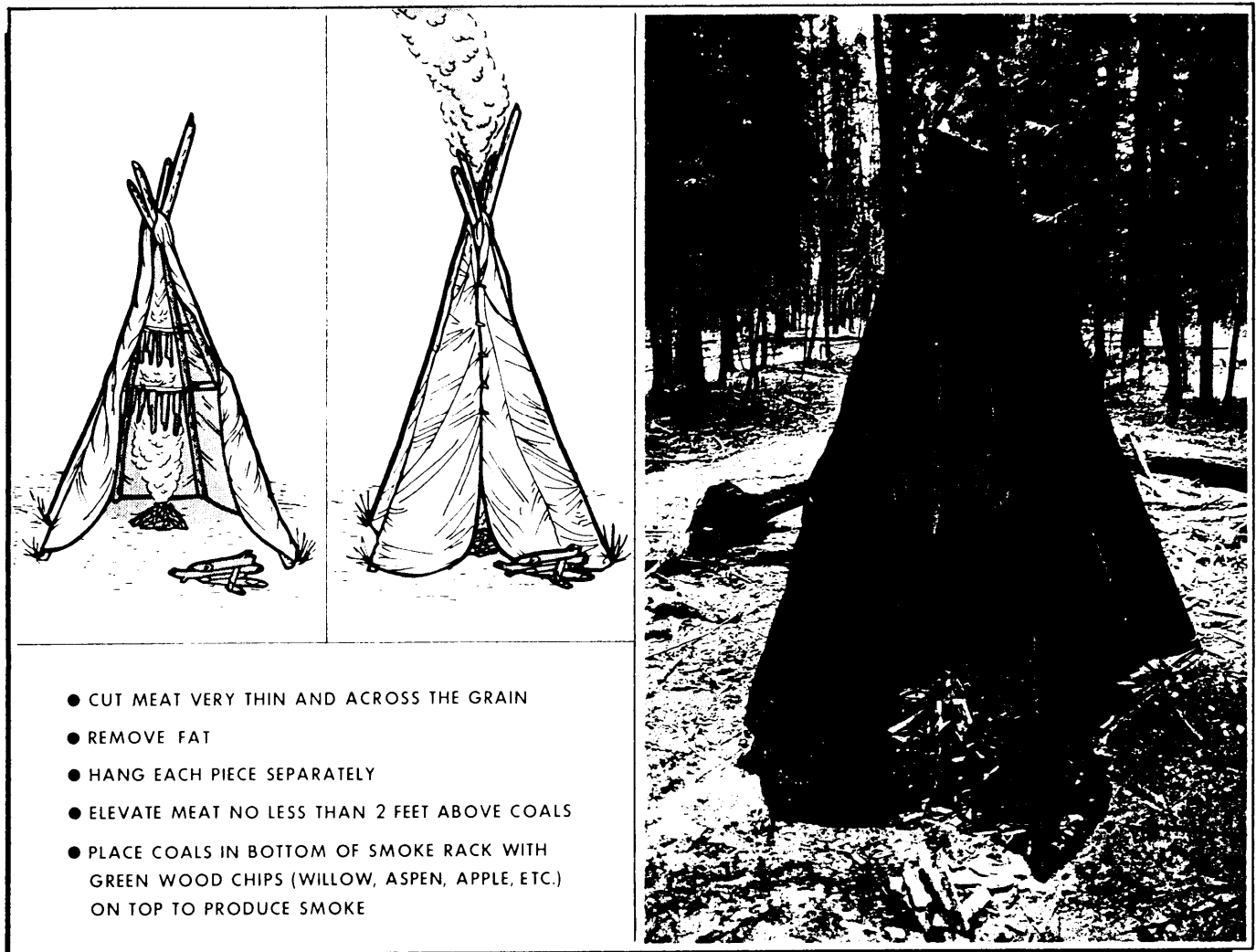

Figure 18-69. Smoke-Drying.

(e) Coals are placed in the bottom of a smoke rack with green woodchips on top to produce smoke.

e. The method used to preserve fish through warm weather is similar to that used in preserving meat (figure 18-70). When there is no danger of predatory animals disturbing the fish, the fish should be placed on available fabric and allowed to cool during the night. Early the next morning, before the air gets warm, the fish should be rolled in moist fabric (and leaves). This bundle can be placed inside the survivor's pack. During the rest periods, or when the pack is removed, it should be placed in a cool location out of the Sun's rays.

(1) Fish may be dried in the same manner described for smoking meat. To prepare fish for smoking, the heads and backbone are removed and the fish are spread flat on a grill. Thin willow branches with bark removed make skewers.

(2) Fish may also be dried in the Sun. They can be suspended from branches or spread on hot rocks. When

the meat has dried, sea water or salt should be used on the outside, if available.

f. In survival environments, there are many animals and insects that will devour a survivor's food if it is not correctly stored. Protecting food from insects and birds is done by wrapping it in parachute material, wrapping and tying brush around the bundle, and finally, wrapping it with another layer of material. This creates "dead air" space making it more difficult for insects and birds to get to the food. If the outer layer is wetted, evaporation will also cool the food to some degree. In most cases, if the food is stored several feet off the ground, it will be out of reach of most animals. This can be done by hanging the food or putting it into a "cache". If the food is dehydrated, the container must be completely waterproof to prevent reabsorption. Frozen food will remain frozen only if the outside temperature remains below freezing. Burying food is a good way to store as long as scavengers are not in the area to uncover it. Insects and small animals should also be

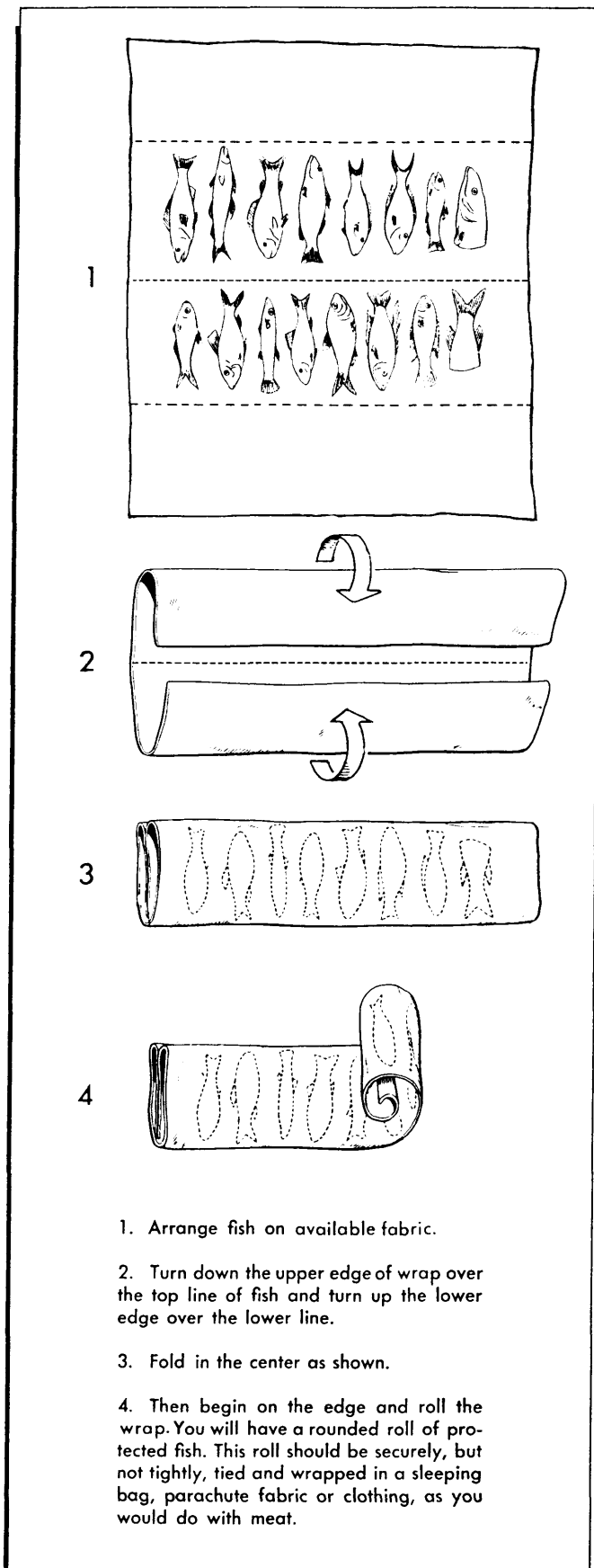

Figure 18-70. Preserving Fish.

remembered when burying the food. Food should never be stored in the shelter as this may attract wild animals and could be hazardous to the survivors.

18-14. Preparing Plant Food. Preparing plant foods can be more involved than preparing animal life.

a. Some plant foods, such as acorns and tree bark may be bitter because of tannin. These plants will require leaching by chopping up the plant parts, and pouring several changes of fresh water over them. This will help wash out the tannin, making the plant more palatable. Other plants such as cassava and green papaya must be cooked before eating to break down the harmful enzymes and chemical crystals within them and make them safe to eat. Plants such as skunk cabbage must undergo this cooking process several times before it is safe to eat.

b. All starchy foods must be cooked since raw starch is difficult to digest. They are boiled, steamed, roasted, or fried and are eaten plain, or mixed with other wild foods. The manioc (cassava) is best cooked, because the bitter form (green stem) is poisonous when eaten raw. Starch is removed from sago palm, cycads, and other starch-producing trunks by splitting the trunk and pounding the soft, whitish inner parts with a pointed club. This pulp is washed with water and the white sago (pure starch) is drained into a container. It is washed a second time, and then it may be used directly as a flour. One trunk of the sago palm will supply a survivor's starch needs for many weeks.

c. The fiddleheads of all ferns are the curled, young succulent fronds which have the same food value as cabbage or asparagus. Practically all types of fiddleheads are covered with hair which makes them bitter. The hair can be removed by washing the fiddleheads in water. If fiddleheads are especially bitter, they should be boiled for 10 minutes and then reboiled in fresh water for 30 to 40 minutes. Wild bird eggs or meat may be cooked with the fiddleheads to form a stew.

d. Wild grasses have an abundance of seeds, which may be eaten boiled or roasted after separating the chaff from the seeds by rubbing. No known grass is poisonous. If the kernels are still soft and do not have large stiff barbs attached, they may be used for porridge. If brown or black rust is present, the seeds should not be eaten (Ergot Poisoning). To gather grass seeds, a cloth is placed on the ground and the grass heads beaten with sticks.

e. Plants that grow in wet places along margins of rivers, lakes, and ponds, and those growing directly in water are of potential value as survival food. The succulent underground parts and stems are most frequently eaten. Poisonous water plants are rare. In temperate climates, the water hemlock is the most poisonous plant found around marshes and ponds. In the tropics, the various members of the calla lily family often grow in very wet places. The leaves of the calla lily look like

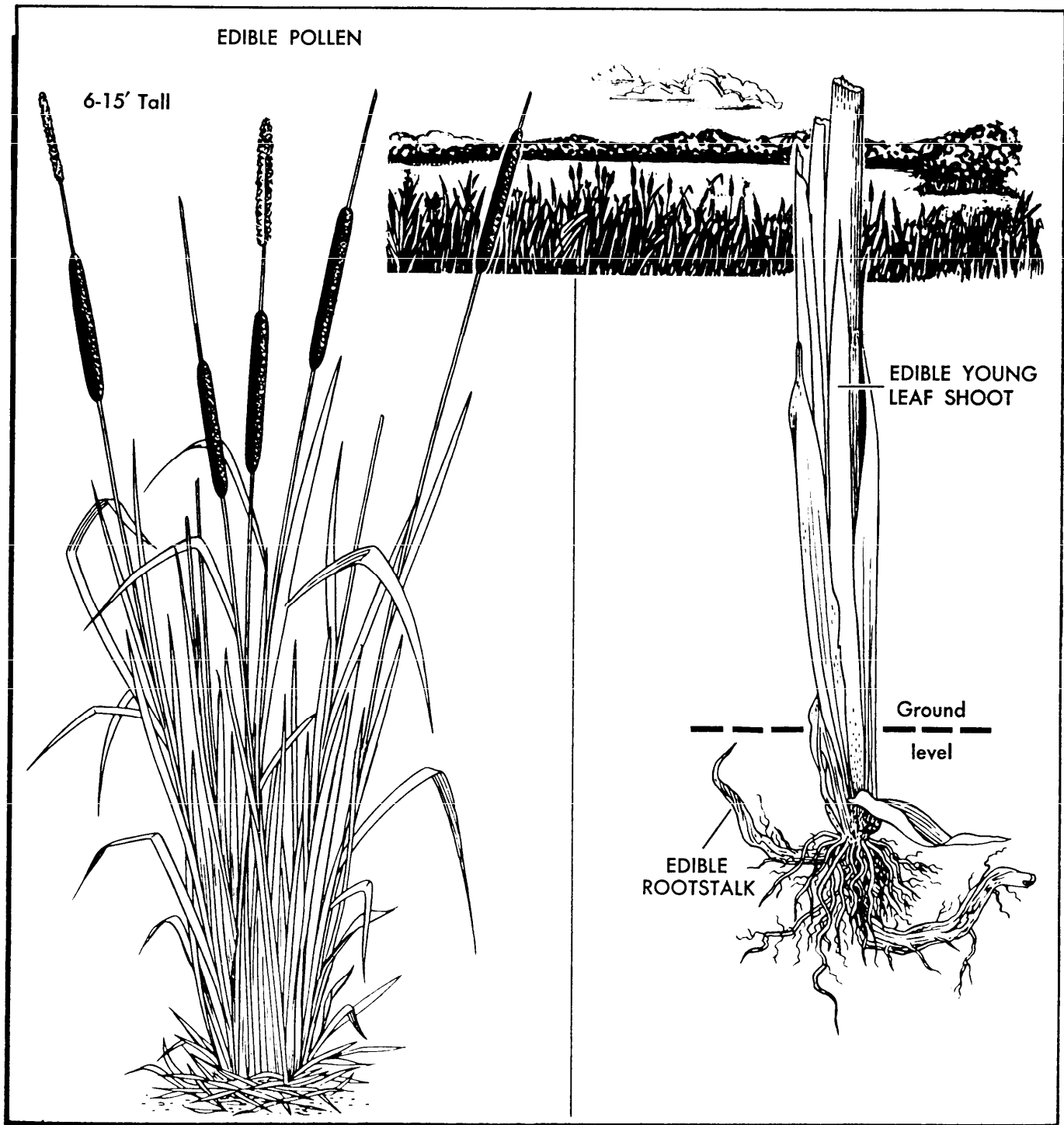

Figure 18-71. Cattails.

arrowheads. Jack-in-the-pulpit, calla lily, and sweet flag are members of the Arum family. To be eaten, the members of this plant family must be cooked in frequent changes of water to destroy the irritant crystals in the stems. Two kinds of marsh and water plants are the cattail and the water lily.

(1) The cattail (*Typha*) is found worldwide except in tundra regions of the far north (figure 18-71). Cattails can be found in the more moist places in desert areas of

all continents as well as in the moist tropic and temperate zones of both hemispheres. The young shoots taste like asparagus. The spikes can be boiled or steamed when green and then eaten. The rootstalks, without the outer covering, are eaten boiled or raw. Cattail roots can be cut into thin strips, dried, and then ground into flour. They are 46 percent starch, 11 percent sugar, and the rest is fiber. While the plant is in flower, the yellow pollen is very abundant; this may be mixed with water

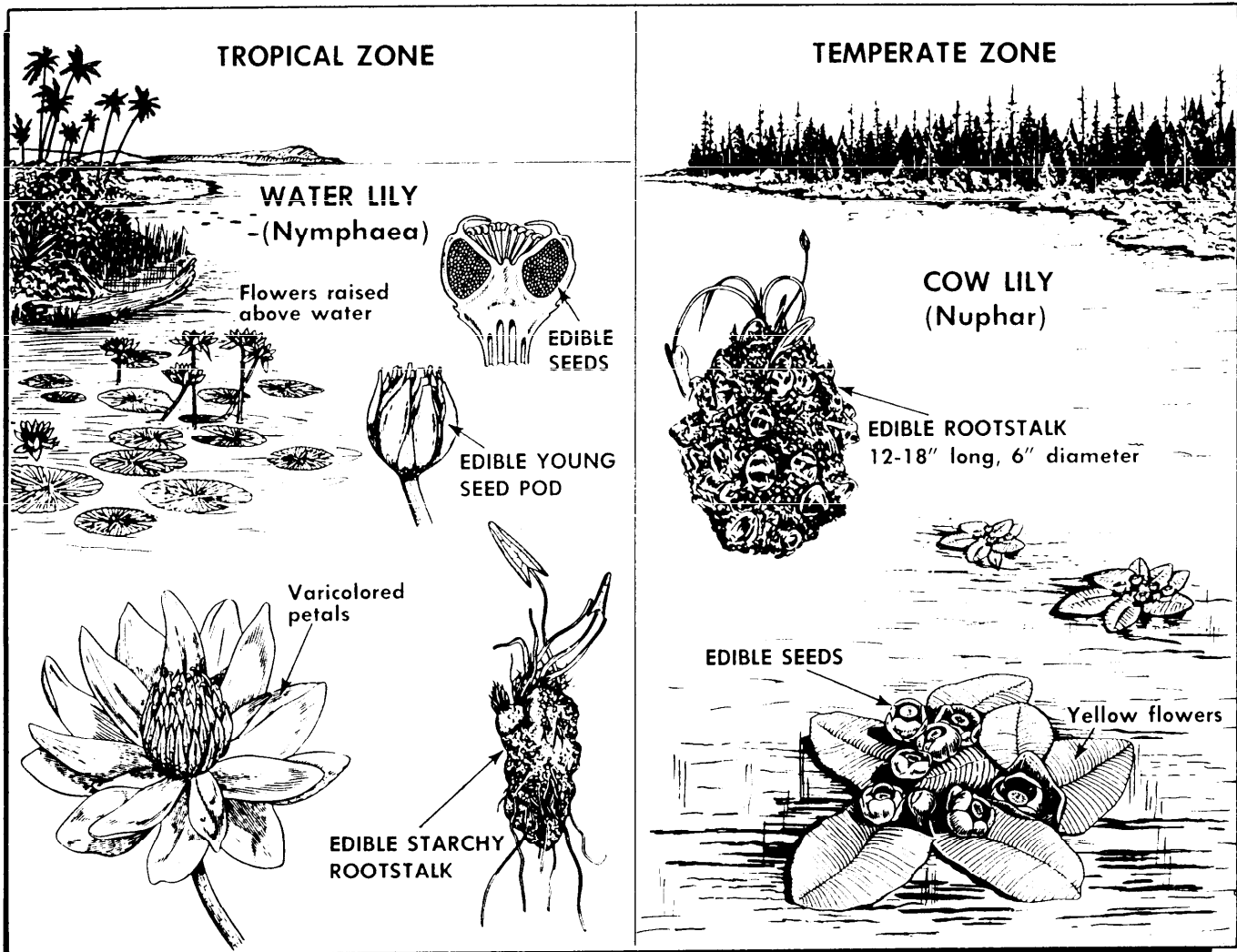

Figure 18-72. Water Lilies.

and made into small cakes and steamed as a substitute for bread.

(2) Water lilies (*Nymphaea* and *Nuphar*) occur on all the continents, but principally in southern Asia, Africa, North America, and South America (figure 18-72). Two main types are:

(a) Temperate water lilies produce enormous rootstalks and yellow or white flowers which float on the water.

(b) Tropical water lilies produce large edible tubers and flowers which are elevated above the water surface.

(3) Rootstalks or tubers may be difficult to obtain because of deep water. They are starchy and high in food value. They can be eaten either raw or boiled. Stems may be cooked in a stew. Young seed pods may be sliced and eaten as a vegetable. Seeds may be bitter, but are very nourishing. They may be parched and rubbed between stones as flour. The water lily is considered an important food source by native peoples in many parts of the world.

f. Nuts are very high in nutritional value and usually can be eaten raw. Nuts may be roasted in the fire or roasted by shaking them in a container with hot coals from the fire. They may then be ground to make a flour. If a survivor does not wish to eat a plant or plant part raw, it can be cooked using the same methods used in cooking meat—by boiling, roasting, baking, broiling, or frying.

g. If survivors have been able to procure more plant foods than can be eaten, the excess can be preserved in the same manner as animal foods. Plant foods can be dried by wind, air, sun, or fire, with or without smoke. A combination of these methods can be used. The main object is to remove the moisture. Most wild fruits can be dried. If the plant part is large, such as some tubers, it should be sliced, and then dried. Some type of protection may be necessary to prevent consumption and (or) contamination by insects. Extra fruits or berries can be carried with the survivor by wrapping them in leaves or moss.

Chapter 19

WATER

19-1. Introduction. Nearly every survival account details the need survivors had for water. Many ingenious methods of locating, procuring, purifying, and storing water are included in the recorded experiences of downed aircrew members. If survivors are located in temperate, tropic, or dry climates, water may be their first and most important need. The priority of finding water over that of obtaining food must be emphasized to potential survivors. An individual may be able to live for weeks without food, depending on the temperature and amount of energy being exerted. A person who has no water can be expected to die within days. Even in cold climate areas or places where water is abundant, survivors should attempt to keep their body fluids at a level that will maintain them in the best possible state of health. Even in relatively cold climates, the body needs 2 quarts of water per day to remain efficient (figure 19-1).

19-2. Water Requirements. Normally, with atmospheric temperature of about 68°F, the average adult requires 2 to 3 quarts of water daily.

a. This water is necessary to replace that lost daily in the following ways:

(1) Urine. Approximately 1.4 quart of water is lost in the urine.

(2) Sweat. About 0.1 quart of water is lost in the sweat.

(3) Feces. Approximately 0.2 quart of water is lost in the feces.

(4) Insensible Water Loss. When the individual is unaware water loss is actually occurring, it is referred to as insensible water loss. Insensible water loss occurs by the following mechanisms:

(a) Diffusion through the skin. Water loss through the skin occurs as a result of the actual diffusion of water molecules through the cells of the skin. The average loss of water in this manner is approximately 0.3 to 0.4 quart. Fortunately, loss of greater quantities of water by diffusion is prevented by the outermost layer of the skin, the epidermis, which acts as a barrier to this type of water loss.

(b) Evaporation through the lungs. Inhaled air initially contains very little water vapor. However, as soon as it enters the respiratory passages, the air is exposed to the fluids covering the respiratory surfaces. By the time this air enters the lungs, it has become totally saturated with moisture from these surfaces. When the air is exhaled, it is still saturated with moisture and water is lost from the body.

b. Larger quantities of water are required when water loss is increased in any one of the following circumstances:

(1) Heat Exposure. When an individual is exposed

to very high temperatures, water lost in the sweat can be increased to as much as 3.5 quarts an hour. Water loss at this increased rate can deplete the body fluids in short time.

(2) Exercise. Physical activity increases the loss of water in two ways as follows:

(a) The increased respiration rate causes increased water loss by evaporation through the lungs.

(b) The increased body heat causes excessive sweating.

(3) Cold Exposure. As the temperature decreases, the amount of water vapor in the air also decreases. Therefore, breathing cold air results in increased water loss by evaporation from the lungs.

(4) High Altitude. At high altitudes, increased water loss by evaporation through the lungs occurs not only as a result of breathing cooler air but also as a result of the increased respiratory efforts required.

(5) Burns. After extensive burns, the outermost layer of the skin is destroyed. When this layer is gone, there is no longer a barrier to water loss by diffusion, and the rate of water loss in this manner can increase up to 5 quarts each day.

(6) Illness. Severe vomiting or prolonged diarrhea can lead to serious water depletion.

c. Dehydration (body fluid depletion) can occur when required body fluids are not replaced.

(1) Dehydration is accompanied by the following symptoms:

(a) Thirst.

(b) Weakness.

(c) Fatigue.

(d) Dizziness.

(e) Headache.

(f) Fever.

(g) Inelastic abdominal skin.

(h) Dry mucous membranes, that is, dry mouth and nasal passages.

(i) Infrequent urination and reduced volume. The urine is concentrated so that it is very dark in color. In severe cases, urination may be quite painful.

(2) Companions will observe the following behavioral changes in individuals suffering from dehydration:

(a) Loss of appetite. (e) Apathy.

(b) Lagging pace. (f) Emotional instability.

(c) Impatience. (g) Indistinct speech.

(d) Sleepiness. (h) Mental confusion.

(3) Dehydration is a complication which causes decreased efficiency in the performance of even the simplest task. It also predisposes survivors to the development of severe shock following minor injuries. Constriction of blood vessels in the skin as a result of dehydration increases the danger of cold injury during

	MAXIMUM DAILY TEMPERATURE (°F) IN SHADE ▼	AVAILABLE WATER PER MAN, US QUARTS					
		0	1 Qt	2 Qts	4 Qts	10 Qts	20 Qts
		DAYS OF EXPECTED SURVIVAL					
	120°	2	2	2	2.5	3	4.5
	110	3	3	3.5	4	5	7
	100	5	5.5	6	7	9.5	13.5
	90	7	8	9	10.5	15	23
	80	9	10	11	13	19	29
	70	10	11	12	14	20.5	32
	60	10	11	12	14	21	32
	50	10	11	12	14.5	21	32

	MAXIMUM DAILY TEMPERATURE (°F) IN SHADE ▼	AVAILABLE WATER PER MAN, US QUARTS					
		0	1 Qt	2 Qts	4 Qts	10 Qts	20 Qts
		DAYS OF EXPECTED SURVIVAL					
	120°	1	2	2	2.5	3	
	110	2	2	2.5	3	3.5	
	100	3	3.5	3.5	4.5	5.5	
	90	5	5.5	5.5	6.5	8	
	80	7	7.5	8	9.5	11.5	
	70	7.5	8	9	10.5	13.5	
	60	8	8.5	9	11	14	
	50	8	8.5	9	11	14	

Figure 19-1. Water Requirements.

cold exposure. Failure to replace body fluids ultimately results in death.

(a) Proper treatment for dehydration is to replace lost body fluids. The oral intake of water is the most readily available means of correcting this deficiency. A severely dehydrated person will have little appetite. This person must be encouraged to drink small quantities of water at frequent intervals to replenish the body's fluid volume. Cold water should be warmed so the system will accept it easier.

(b) To prevent dehydration, water loss must be replaced by periodic intake of small quantities of water throughout the day. As activities or conditions intensify, the water intake should be increased accordingly. Water intake should be sufficient to maintain a minimum urinary output of 1 pint every 24 hours. Thirst is not an adequate stimulus for water intake, and a person often dehydrates when water is available. Therefore, water intake should be encouraged when the person is not thirsty. Humans cannot adjust to decreased water

intake for prolonged periods of time. When water is in short supply, any available water should be consumed sensibly. If sugar is available, it should be mixed with the water, and efforts should be made to find a local water source. Until a suitable water source is located, individual water losses should be limited in the following ways:

-1. Physical activity should be limited to the absolute minimum required for survival activities. All tasks should be performed slowly and deliberately with minimal expenditure of energy. Frequent rest periods should be included in the daily schedule.

-2. In hot climates, essential activity should be conducted at night or during the cooler part of the day.

-3. In hot climates, clothing should be worn at all times because it reduces the quantity of water loss by sweating. Sweat is absorbed into the clothing evaporated from its surface in the same manner it evaporates from the body. This evaporation cools the air trapped between the clothing and the skin, causing a decrease in

the activity of the sweat glands and a subsequent reduction in water loss.

-4. In hot weather, light-colored clothing should be worn rather than dark-colored clothing. Dark-colored clothing absorbs the Sun's light rays and converts them into heat. This heat causes an increase in body temperatures which activates the sweat glands and increases water loss through sweating. Light-colored clothing, however, reflects the Sun's light rays, minimizing the increase in body temperature and subsequent water loss.

19-3. Water Sources. Survivors should be aware of both the water sources available to them and the resources at their disposal for producing water.

a. Survivors may obtain water from solar stills, desalter kits, or canned water packed in various survival kits. It would be wise for personnel, who may one day have to use these methods of procuring water, to be knowledgeable of their operating instructions and the amount of water they produce.

(1) Canned water provides 10 ounces per can.

(2) Desalter kits are limited to 1 pint per chemical bar—kits contain eight chemical bars.

(3) A "sea solar still" can produce as much as 2½ pints per day.

(4) "Land solar stills" produce varied amounts of water. This amount is directly proportionate to the amount of water available in the soil or placed into the still (vegetation, entrails, contaminated water, etc.), and the ambient temperature.

b. Aircrew members would be wise to carry water during their missions. Besides the fact that the initial shock of the survival experience sometimes produces feelings of thirst, having an additional water container can benefit survivors. The issued items (canned water, desalter kits, and solar stills) should be kept by survivors for times when no natural sources of freshwater are available.

c. Naturally occurring indicators of water are:

(1) Surface water, including streams, lakes, springs, ice, and snow.

(2) Precipitation, such as rain, snow, dew, sleet, etc.

(3) Subsurface water, which may not be as readily accessible as wells, cisterns, and underground springs and streams, can be difficult for survivors to locate and use.

d. Several indicators of possible water are:

(1) Presence of abundant vegetation of a different variety, such as deciduous growth in a coniferous area.

(2) Drainages and low-lying areas.

(3) Large clumps of plush grass.

(4) Animal trails which may lead to water. The "V" formed by intersecting trails often point toward water sources.

e. Survivors may locate and procure water as follows:

(1) Precipitation may be procured by laying a piece of nonporous material such as a poncho, piece of can-

vas, plastic, or metal material on the ground. If rain or snow is being collected, it may be more efficient to create a bag or funnel shape with the material so the water can be easily gathered. Dew can be collected by wiping it up with a sponge or cloth first, and then wringing it into a container (figure 19-2). Consideration should be given to the possibility of contaminating the water with dyes, preservatives, or oils on the surfaces of the objects used to collect the precipitation. Ice will yield more water per given volume than snow and requires less heat to do so. If the Sun is shining, snow or ice may be placed on a dark surface to melt (dark surfaces absorb heat, whereas light surfaces reflect heat). Ice can be found in the form of icicles on plants and trees, sheet ice on rivers, ponds, and lakes, or sea ice. If snow must be used, survivors should use snow closest to the ground. This snow is packed and will provide more water for the amount of snow than will the upper layers. When snow is to be melted for water, place a small amount of snow in the bottom of the container being used and place it over or near a fire. Snow can be added a little at a time. Survivors should allow water in the container bottom to become warm so that when more snow is added, the mixture remains slushy. This will prevent burning the bottom out of the container. Snow absorbs water, and if packed, forms an insulating airspace at the bottom of the container. When this happens, the bottom may burn out.

(2) Several things may help survivors locate ground water, such as rivers, lakes, and streams.

(a) The presence of swarming insects indicates water is near. In some places, survivors should look for signs of animal presence. For example, in damp places, animals may have scratched depressions into the ground to obtain water; insects may also hover over these areas.

(b) In the Libyan Sahara, donut-shaped mounds of camel dung often surround wells or other water sources. Bird flights can indicate direction to or from water. Pigeons and doves make their way to water regularly. They fly from water in the morning and to it in the evening. Large flocks of birds may also congregate around or at areas of water.

(c) The presence of people will indicate water. The location of this water can take many forms—stored water in containers that are carried with people who are traveling, wells, irrigation systems, pools, etc. Survivors who are evaders should be extremely cautious when approaching any water source, especially if they are in dry areas; these places may be guarded or inhabited.

(3) When no surface water is available, survivors may have to tap the Earth's supply of ground water. Access to this depends upon the type of ground—rock or loose material, clay, gravel, or sand.

(a) In rocky ground, survivors should look for springs and seepages. Limestone and lava rocks will have more and larger springs than any other rocks. Most

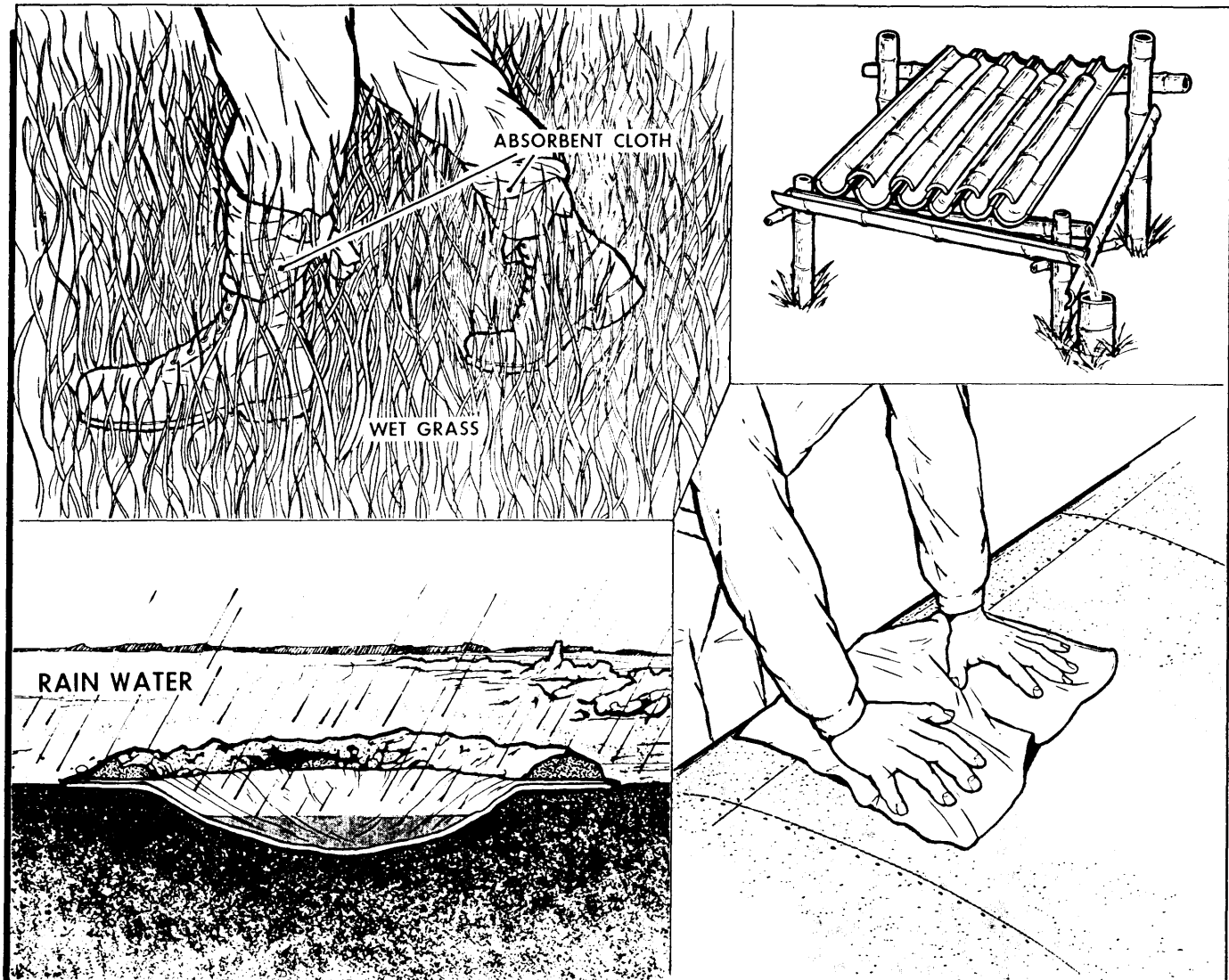

Figure 19-2. Methods of Procuring Water.

lava rocks contain millions of bubble holes; ground water may seep through them. Survivors can also look for springs along the walls of valleys that cross a lava flow. Some flows will have no bubbles but do have “organ pipe” joints—vertical cracks that part the rocks into columns a foot or more thick and 20 feet or more high. At the foot of these joints, survivors may find water creeping out as seepage, or pouring out in springs.

(b) Most common rocks, like granite, contain water only in irregular cracks. A crack in a rock with bird dung around the outside may indicate a water source that can be reached by a piece of surgical hose used as a straw or siphon.

(c) Water is more abundant and easier to find in loose sediments than in rocks. Springs are sometimes found along valley floors or down along their sloping sides. The flat benches or terraces of land above river

valleys usually yield springs or seepages along their bases, even when the stream is dry. Survivors shouldn't waste time digging for water unless there are signs that water is available. Digging in the floor of a valley under a steep slope, especially if the bluff is cut in a terrace, can produce a water source. A lush green spot where a spring has been during the wet season is a good place to dig for water. Water moves slowly through clay, but many clays contain strips of sand which may yield springs. Survivors should look for a wet place on the surface of clay bluffs and try digging it out.

(d) Along coasts, water may be found by digging beach wells (figure 19-3). Locate the wells behind the first or second pressure ridge. Wells can be dug 3 to 5 feet deep and should be lined with driftwood to prevent sand from refilling the hole. Rocks should be used to line the bottom of the well to prevent stirring up sand

when procuring the water. The average well may take as long as 2 hours to produce 4 to 5 gallons of water. (Do not be discouraged if the first try is unsuccessful—dig another.)

19-4. Water in Snow and Ice Areas. Due to the extreme cold of arctic areas, water requirements are greatly increased. Increased body metabolism, respiration of cold air, and extremely low humidity play important roles in reducing the body's water content. The processes of heat production and digestion in the body also increase the need for water in colder climatic zones. The constructing of shelters and signals and the obtaining of firewood are extremely demanding tasks for survivors. Physical exertion and heat production in extreme cold place the water requirements of a survivor close to 5 or 6 quarts per day to maintain proper hydration levels. The diet of survivors will often be dehydrated rations and high protein food sources. For the body to digest and use these food sources effectively, increased water intake is essential.

a. Obtaining water need not be a serious problem in the arctic because an abundant supply of water is available from streams, lakes, ponds, snow, and ice. All sur-

face water should be purified by some means. In the summer, surface water may be discolored but is drinkable when purified. Water obtained from glacier-fed rivers and streams may contain high concentrations of dirt or silt. By letting the water stand for a period of time, most silt will settle to the bottom; the remaining water can be strained through porous material for further filtration.

b. A "water machine" can be constructed which will produce water while the survivors are doing other tasks. It can be made by placing snow on any porous material (such as parachute or cotton), gathering up the edges, and suspending the "bag" of snow from any support near the fire. Radiant heat will melt the snow and the water will drip from the lowest point on the bag. A container should be placed below this point to catch the water (figure 19-4).

c. In some arctic areas, there may be little or no fuel supply with which to melt ice and snow for water. In this case, body heat can be used to do the job. The ice or snow can be placed in a waterproof container like a waterbag and placed between clothing layers next to the body. This cold substance should not be placed directly

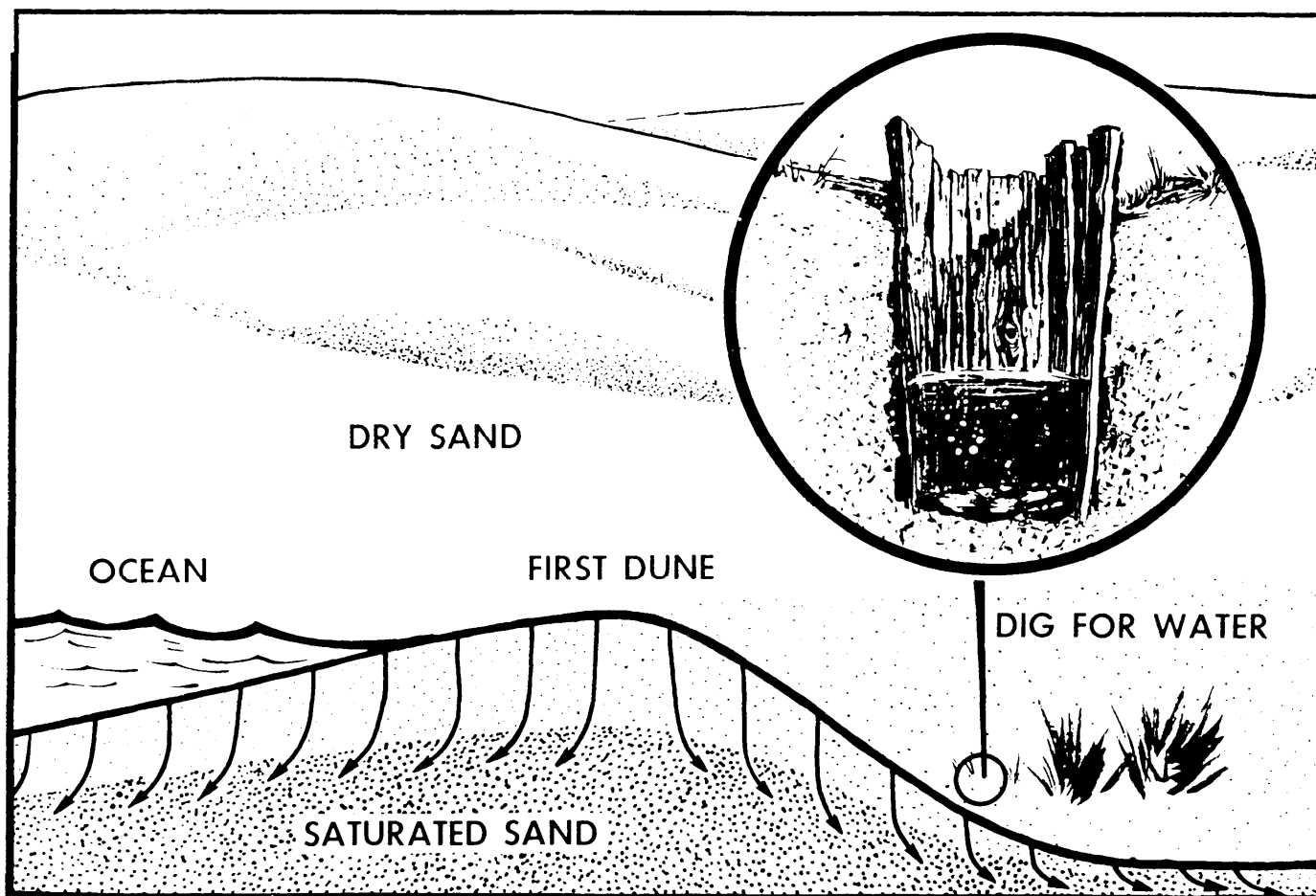

Figure 19-3. Beach Well.

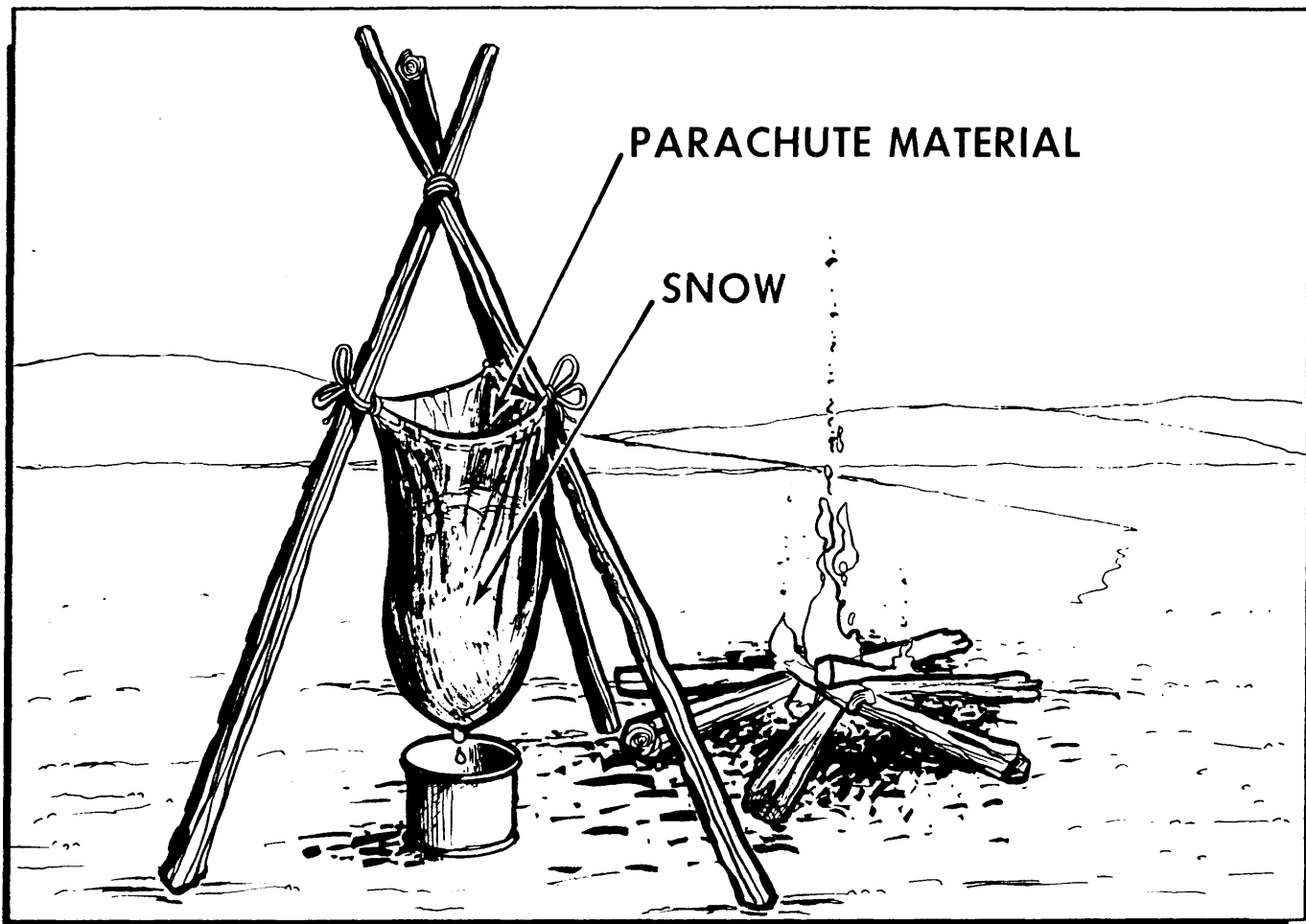

Figure 19-4. Water Machine.

next to the skin; it causes chilling and lowering of the body temperature.

d. Since icebergs are composed of freshwater, they can be a readily available source of drinking water. Survivors should use extreme caution when trying to obtain water from this source. Even large icebergs can suddenly roll over and dump survivors into the frigid sea water. If sea ice is the primary source of water, survivors should recall that like seawater itself, saltwater ice should never be ingested. To obtain water in polar regions or sea ice areas, survivors should select old sea ice, a bluish or blackish ice which shatters easily and generally has rounded corners. This ice will be almost salt-free. New sea ice is milky or gray colored with sharp edges and angles. This type of ice will not shatter or break easily. Snow and ice may be saturated with salt from blowing spray; if it tastes salty, survivors should select different snow or ice sources.

e. The ingesting of unmelted snow or ice is not recommended. Eating snow or ice lowers the body's temperature, induces dehydration, and causes minor cold injury to lips and mouth membranes. Water consumed in cold

areas should be in the form of warm or hot fluids. The ingestion of cold fluids or foods increases the body's need for water and requires more body heat to warm the substance.

19-5. Water on the Open Seas. The lack of drinkable water could be a major problem on the open seas. Seawater should never be ingested in its natural state. It will cause an individual to become violently ill in a very short period of time. When water is limited and cannot be replaced by chemical or mechanical means, it must be used efficiently. As in the desert, conserving sweat not water, is the rule. Survivors should keep in the shade as much as possible and dampen clothing with seawater to keep cool. They should not over exert but relax and sleep as much as possible.

a. If it rains, survivors can collect rainwater in available containers and store it for later use. Storage containers could be cans, plastic bags, or the bladder of a life preserver. Drinking as much rainwater as possible while it is raining is advisable. If the freshwater should become contaminated with small amounts of seawater

or salt spray, it will remain safe for drinking (figure 19-5). At night and on foggy days, survivors should try to collect dew for drinking water by using a sponge, chamois, handkerchief, etc.

b. Solar stills will provide a drinkable source of water. Survivors should read the instructions immediately and set them up, using as many stills as available. (Be sure to attach them to the raft.) Desalter kits, if available, should probably be saved for the time when no other means of procuring drinking water is available. Instructions on how to use the desalter kit are on the container.

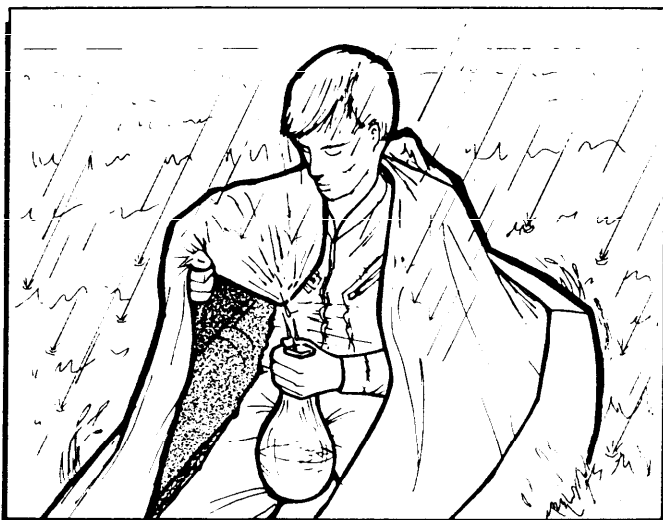

Figure 19-5. Collecting Water from Spray Shield.

c. Only water in its conventional sense should be consumed. The so-called "water substitutes" do little for the survivor, and may do much more harm than not consuming any water at all. There is no substitute for water. Fish juices and other animal fluids are of doubtful value in preventing dehydration. Fish juices contain protein which requires large amounts of water to be digested and the waste products must be excreted in the urine which increases water loss. Survivors should never drink urine—urine is body waste material and only serves to concentrate waste materials in the body and require more water to eliminate the additional waste.

19-6. Water in Tropical Area. Depending on the time of the year and type of jungle, water in the tropical climates can be plentiful; however, it is necessary to know where to look and procure it. Surface water is normally available in the form of streams, ponds, rivers, and swamps. In the savannas during the dry season, it may be necessary for the survivor to resort to digging for water in the places previously mentioned. Water obtained from these sources may need filtration and should be purified. Jungle plants can also provide survivors with water.

a. Many plants have hollow portions which can collect rainfall, dew, etc. (figure 19-6). Since there is no absolute way to tell whether this water is pure, it should be purified. The stems or the leaves of some plants have a hollow section where the stem meets the trunk. Look for water collected here. This includes any Y-shaped plants (palms or air plants). The branches of large trees often support air plants (relatives of the pineapple) whose overlapping, thickly growing leaves may hold a considerable amount of rainwater. Trees may also catch and store rainwater in natural receptacles such as cracks or hollows.



Figure 19-6. Water Collectors.

b. Pure freshwater needing no purification can be obtained from numerous plant sources. There are many varieties of vines which are potential water sources. The vines are from 50 feet to several hundred feet in length and 1 to 6 inches in diameter. They also grow like a hose along the ground and up into the trees. The leaf structure of the vine is generally high in the trees. Water

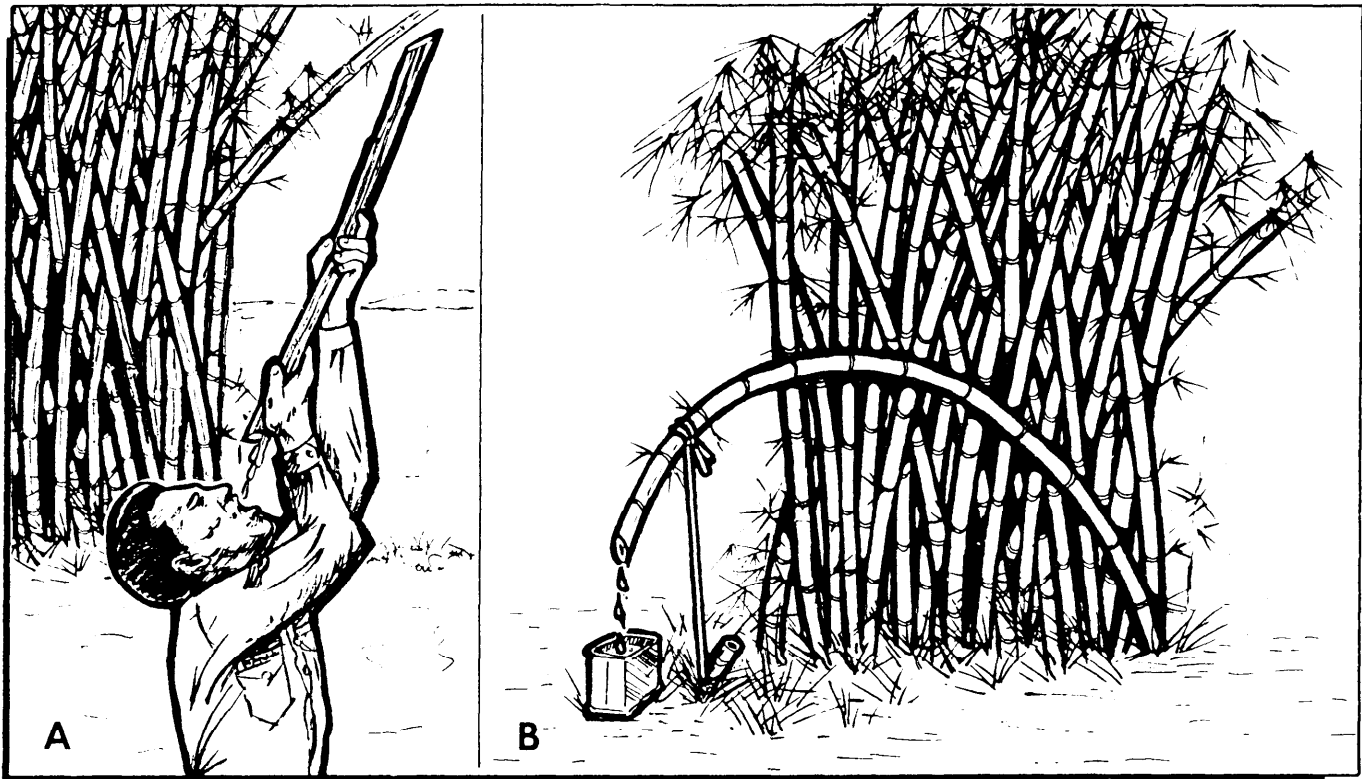

Figure 19-7. Water Vines and Bamboo.

vines are usually soft and easily cut. The smaller species may be twisted or bent easily and are usually heavy because of the water content. The water from these vines should be tested for potability. The first step in testing the water from vines is for survivors to nick the vine and watch for sap running from the cut. If milky sap is seen, the vine should be discarded; if no milky sap is observed, the vine may be a safe water vine. Survivors should cut out a section of the vine, hold that piece vertically, and observe the liquid as it flows out. If it is clear and colorless, it may be a drinkable source. If it is cloudy or milky-colored, they should discard the vine. They should let some of the liquid flow into the palm of the hand and observe it. If the liquid does not change color, they can now taste it. If it tastes like water or has a woody or sweet taste, it should be safe for drinking. Liquid with a sour or bitter taste should be avoided. Water trapped within a vine is easily obtained by cutting out a section of the vine. The vine should first be cut high above the ground and then near the ground. This will provide a long length of vine and, in addition, will tend to hide evidence of the cuts if the survivors are in an evasion situation. When drinking from the vine, it should not touch the mouth as the bark may contain irritants which could affect the lips and mouth (figure 19-7). The pores in the upper end of the section of vine may reclose, stopping the flow of water. If this occurs,

survivors should cut off the end of the vine opposite the drinking end. This will reopen the pores allowing the water to flow.

c. Water from the rattan palm and spiny bamboo may be obtained in the same manner as from vines. It is not necessary to test the water if positive identification of the plant can be made. The slender stem (runner) of the rattan palm is an excellent water source. The joints are overlapping in appearance, as if one section is fitted inside the next.

d. Water may be trapped within sections of green bamboo. To determine if water is trapped within a section of bamboo, it should be shaken. If it contains water, a sloshing sound can be heard. An opening may be made in the section by making two 45-degree angle cuts, both on the same side of the section, and prying loose a piece of the section wall. The end of the section may be cut off and the water drunk or poured from the open end. The inside of the bamboo should be examined before consuming the water. If the inside walls are clean and white, the water will be safe to drink. If there are brown or black spots, fungus growth, or any discoloration, the water should be purified before consumption. Sometimes water can also be obtained by cutting the top off certain types of green bamboo, bending it over, and staking it to the ground (figure 19-7). A water container should be placed under it to catch the

dripping water. This method has also proven effective on some vines and the rattan palm.

e. Water can also be obtained from banana plants in a couple of different ways, neither of which is satisfactory in a tactical situation. First, survivors should cut a banana plant down, then a long section should be cut off which can be easily handled. The section is taken apart by slitting from one end to the other and pulling off the layers one at a time. A strip 3 inches wide, the length of the section, and just deep enough to expose the cells should be removed from the convex side. This section is folded toward the convex side to force the water from the cells of the plant. The layer must be squeezed gently to avoid forcing out any tannin into the water. Another technique for obtaining water from the banana plant is by making a "banana-well." This is done by making a bowl out of the plant stump, fairly close to the ground, by cutting out and removing the inner section of the stump (figure 19-8). Water which first enters the bowl may contain a concentration of tannin (an astringent which has the same effect as alum). A leaf from the banana plant or other plant should be placed over the bowl while it is filling to prevent contamination by insects, etc.

f. Water trees can also be a valuable source of water in some jungles. They can be identified by their blotched bark which is fairly thin and smooth. The leaves are large, leathery, fuzzy, and evergreen, and may grow as large as 8 or 9 inches. The trunks may have short outgrowths with fig-like fruit on them or long tendrils with round fruit comprised of corn kernel-shaped nuggets. In a nontactical situation, the tree can be tapped in the same manner as a rubber tree, with either a diagonal slash or a "V." When the bark is cut into, it will exude a white sap which if ingested causes temporary irritation of the urinary tract. This sap dries up quite rapidly and can easily be removed. The cut should be continued into the tree with a spigot (bamboo, knife, etc.) at the bottom of the tap to direct the water into a container. The water flows from the leaves back into the roots after sundown, so water can be procured from this source only after sundown or on overcast (cloudy) days. If survivors are in a tactical situation, they can obtain water from the tree and still conceal the procurement location. If the long tendrils are growing thickly, they can be separated and a hole bored into the tree. The white sap should be scraped off and a spigot placed below the tap with a water container to catch the water. Moving the tendrils back into place will conceal the container. Instead of boring into the tree, a couple of tendrils can be cut off or snapped off if no knife is available. The white sap should be allowed to dry and then be removed. The ends of the tendrils should be placed in a water container and the container concealed.

g. Coconuts contain a refreshing fluid. Where coconuts are available, they may be used as a water source. The fluid from a mature coconut contains oil, which

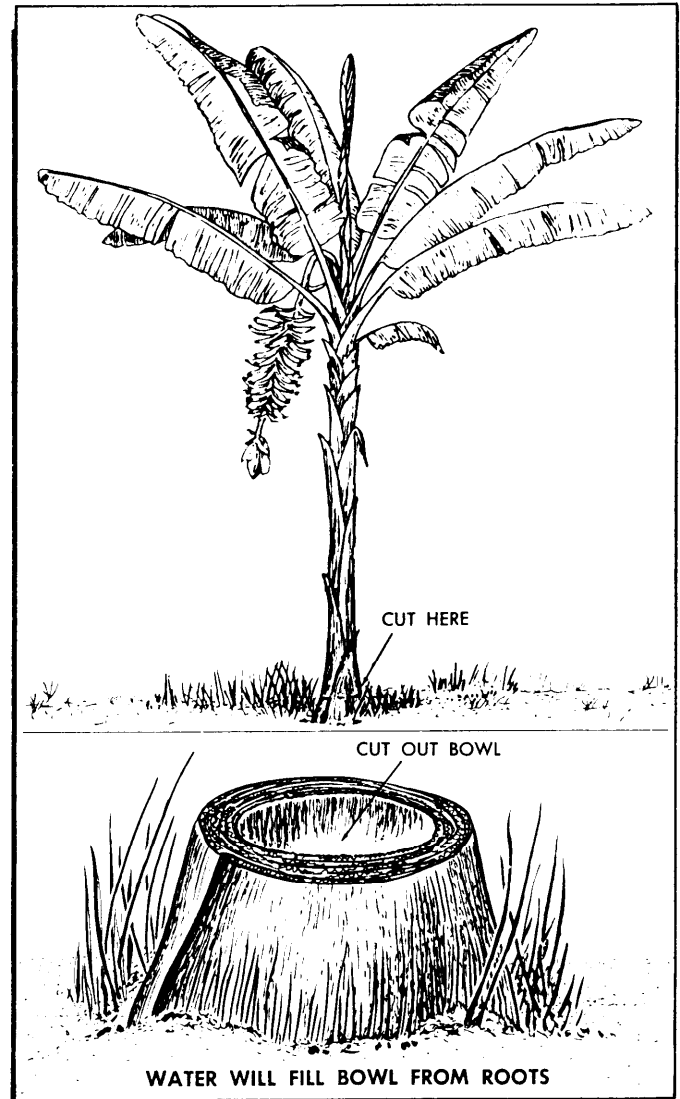

Figure 19-8. Water from Banana Plant.

when consumed in excess can cause diarrhea. There is little problem if used in moderation or with a meal and not on an empty stomach. Green unripe coconuts about the size of a grapefruit are the best for use because the fluid can be taken in large quantities without harmful effects. There is more fluid and less oils so there is less possibility of diarrhea.

h. Water can also be obtained from liquid mud. Mud can be filtered through a piece of cloth. Water taken by this method must be purified. Rainwater can be collected from a tree by wrapping a cloth around a slanted tree and arranging the bottom end of the cloth to drip into a container (figure 19-9).

19-7. Water in Dry Areas. Locating and procuring water in a dry environment can be a formidable task. Some of the ways to find water in this environment have been

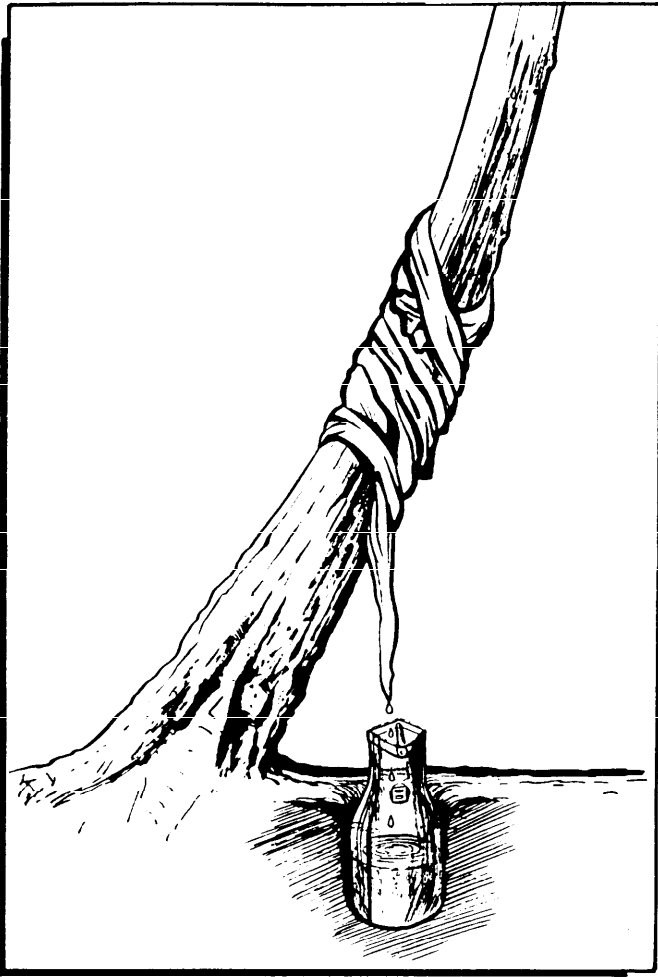

Figure 19-9. Collecting Water from Slanted Tree.

and the liquid from each section of root drained into a container. The liquid can also be sucked out. The trees growing in hollows or depressions will have the most water in their roots. Roots that are 1 to 2 inches thick are an ideal size. Water can be carried in these roots by plugging one end with clay.

c. Cactus-like or succulent plants may be sources of water for survivors, but they should recall that no plants should be used for water procurement which have a milky sap. The barrel cactus of the United States provides a water source. To obtain it, survivors should first cut off the top of the plant. The pulpy inside portions of the plant should then be mashed to form a watery pulp. Water may ooze out and collect in the bowl; if not, the pulp may be squeezed through a cloth directly into the mouth.

d. The solar still is a method of obtaining water that uses both vegetation and ground moisture to produce water (figure 19-11). A solar still can be made from a sheet of clear plastic stretched over a hole in the ground. The moisture in the soil and from plant parts (fleshy stems and leaves) will be extracted and collected by this emergency device. Obviously, where the soil is extremely dry and no fleshy plants are available, little, if any, water can be obtained from the still. The still may also be used to purify polluted water.

(1) The parts for the still are a piece of plastic about 6 feet square, a water collector-container or any waterproof material from which a collector-container can be fashioned, and a piece of plastic tubing about one-fourth inch in diameter and 4 to 6 feet long. The tubing is not absolutely essential but makes the still easier to use. A container can be made from such materials as plastic, aluminum foil, poncho, emergency ration tins, or a flight helmet. The tubing, when available, is fastened to the bottom of the inside of the container and used to remove drinking water from the container without disturbing the plastic. Some plastics work better than others, although any clear plastic should work if it is strong.

(2) If plants are available or if polluted water is to be purified, the still can be constructed in any convenient spot where it will receive direct sunlight throughout the day. Ease of digging will be the main consideration. If soil moisture is to be the only source of water, some sites will be better than others. Although sand generally does not retain as much moisture as clay, a wet sand will work very well. Along the seacoast or in any inland areas where brackish or polluted water is available, any wet soil, even sand, produces usable amounts of water. On cloudy days, the yield will be reduced because direct sunlight is necessary if the still is to operate at full efficiency.

(3) Certain precautions must be kept in mind. If polluted water is used, survivors should make sure that none is spilled near the rim of the hole where the plastic touches the soil and that none comes in contact with the

explored, such as locating a concave bend in a dry riverbed and digging for water (figure 19-10). If there is any water within a few feet of the surface, the sand will become slightly damp. Dig until water is obtained.

a. Some deserts become humid at night. The humidity may be collected in the form of dew. This dew can be collected by digging a shallow basin in the ground about 3 feet in diameter and lining it with a piece of canvas, plastic, or other suitable material. A pyramid of stones taken from a minimum of 1 foot below the surface should then be built in this basin. Dew will collect on and between the stones and trickle down onto the lining material where it can be collected and placed in a container.

b. Plants and trees having roots near the surface may be a source of water in dry areas. Water trees of dry Australia are a source of water, as their roots run out 40 to 80 feet at a depth of 2 to 9 inches under the surface. Survivors may obtain water from these roots by locating a root 4 to 5 feet from the trunk and cutting the root into 2- or 3-foot lengths. The bark can then be peeled off

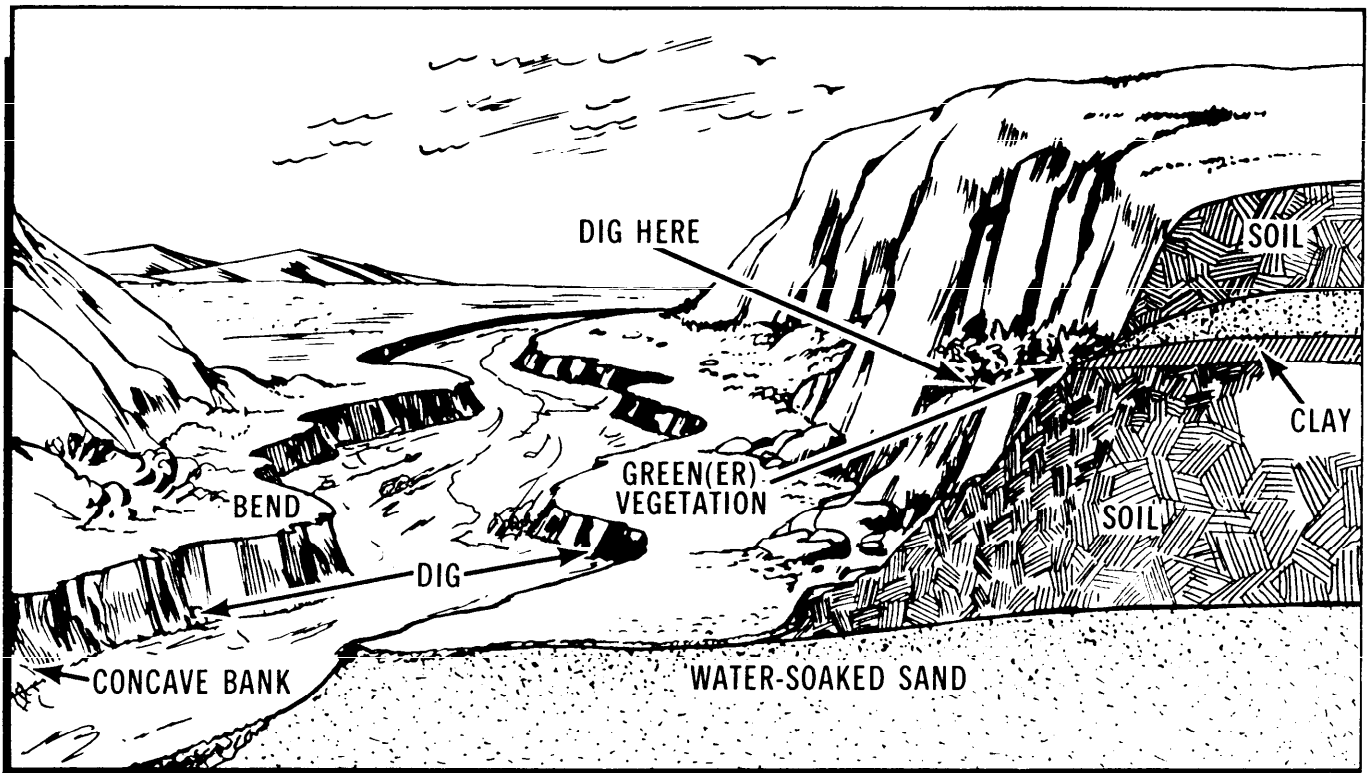

Figure 19-10. Dry Stream Bed.

container to prevent the freshly distilled water becoming contaminated. Survivors should not disturb the plastic sheet during daylight "working hours" unless it is absolutely necessary. If a plastic drinking tube is not available, raise the plastic sheet and remove the container as few times as possible during daylight hours. It takes one-half hour for the air in the still to become resaturated and the collection of water to begin after the plastic has been disturbed. Even when placed on fairly damp soil and in an area where 8 hours of light per day is directed on the solar still, the average yield is only about 1 cup per day per still. Due to the low yields obtained from this device, survivors must give consideration to the possible danger of excessive dehydration brought about by constructing the solar still. In certain circumstances, solar still returns, even over 2- or 3-day periods, will not equal the amount of body fluid lost in construction and will actually hasten dehydration.

(4) Steps survivors should follow when constructing a solar still are: Dig a bowl-shaped hole in the soil about 40 inches in diameter and 20 inches deep. Add a smaller, deeper sump in the center bottom of the hole to accommodate the container. If polluted waters are to be purified, a small trough can be dug around the side of the hole about halfway down from the top. The trough ensures that the soil wetted by the polluted water will be exposed to the sunlight and at the same time that the

polluted water is prevented from running into the container. If plant material is used, line the sides of the hole with pieces of plant or its fleshy stems and leaves. Place the plastic over the hole and put soil on the edges to hold it in place. Place a rock no larger than a plum in the center of the plastic until it is about 15 inches below ground level. The plastic will now have the shape of a cone. Put more soil on the plastic around the rim of the hole to hold the cone securely in place and to prevent water-vapor loss. Straighten the plastic to form a neat cone with an angle of about 30 degrees so the water drops will run down and fall into the container. It takes about 1 hour for the air to become saturated and start condensing on the underside of the plastic cone.

e. The vegetation bag is a simpler method of water procurement. This method involves cutting foliage from trees or herbaceous plants, sealing it in a large clear plastic bag, and allowing the heat of the Sun to extract the fluids contained within. A large, heavy-duty clear plastic bag should be used. The bag should be filled with about 1 cubic yard of foliage, sealed, and exposed to the Sun. The average yield for one bag tested was 320 ml/bag 5-hour day. This method is simple to set up. The vegetation bag method of water procurement does have one primary drawback. The water produced is normally bitter to taste, caused by biological breakdown of the leaves as they lay in the water produced and super-

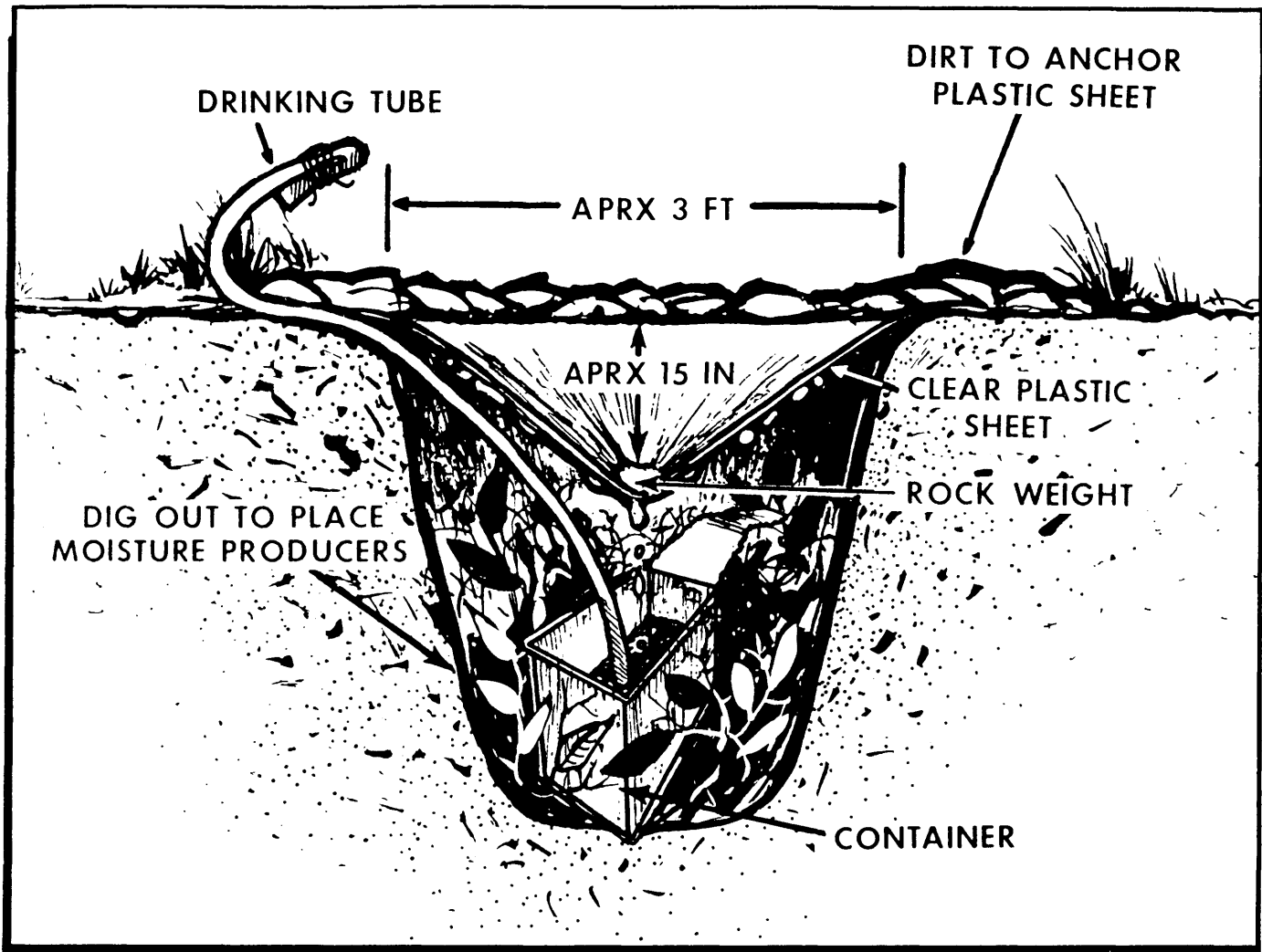

Figure 19-11. Solar Still.

heated in the moist "hothouse" environment. This method can be readily used in a survival situation, but before the water produced by certain vegetation is consumed, it should undergo the taste test. This is to guard against ingestion of cyanide-producing substances and other harmful toxins, such as plant alkaloids. (See figure 19-12.)

f. One more method of water procurement is the water transpiration bag, a method that is simple to use and has great potential for enhancing survival. This method is the vegetation bag process taken one step further. A large plastic bag is placed over a living limb of a medium-size tree or large shrub. The bag opening is sealed at the branch, and the limb is then tied down to allow collected water to flow to the corner of the bag. For a diagram of the water transpiration method, see figure 19-13.

(1) The amount of water yielded by this method will depend on the species of trees and shrubs available. During one test of this method, a transpiration bag produced approximately a gallon per day for 3 days with a

plastic bag on the same limb, and with no major deterioration of the branch. Other branches yielded the same amount. Transpired water has a variety of tastes depending on whether or not the vegetation species is allowed to contact the water.

(2) The effort expended in setting up water transpiration collectors is minimal. It takes about 5 minutes' work and requires no special skills once the method has been described or demonstrated. Collecting the water in a survival situation would necessitate survivors dismantling the plastic bag at the end of the day, draining the contents and setting it up again the following day. The same branch may be reused (in some cases with almost similar yields); however, as a general rule, when vegetation abounds, a new branch should be used each day.

(3) Without a doubt, the water transpiration bag method surpasses other methods (solar stills, vegetation bag, cutting roots, barrel cactus) in yield, ease of assembly, and in most cases, taste. The benefits of having a simple plastic bag can't be over-emphasized. As a water procurer, in dry, semi-dry, or desert environments

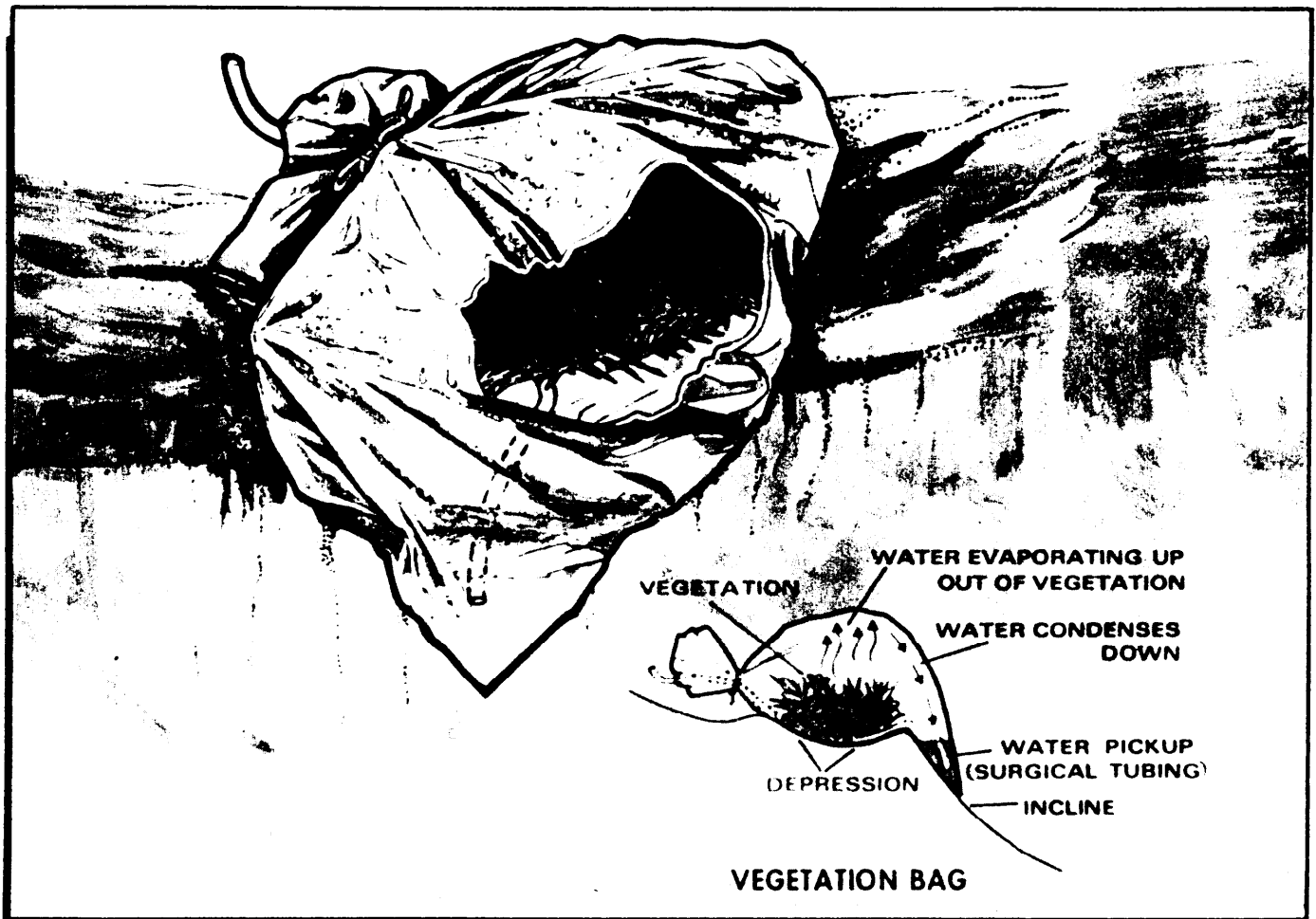

Figure 19-12. Vegetation Bag.

where low woodlands predominate, it can be used as a water transpirator; in scrubland, steppes, or treeless plains, as a vegetation bag; in sandy areas without vegetation, it can be cut up and improvised into solar stills. Up to three large, heavy-duty bags may be needed to sustain one survivor in certain situations.

19-8. Preparation of Water for Consumption:

a. The following are ways survivors can possibly determine the presence of harmful agents in the water:

- (1) Strong odors, foam, or bubbles in the water.
- (2) Discoloration or turbid (muddy with sediment).
- (3) Water from lakes found in desert areas are sometimes salty because they have been without an outlet for extended periods of time. Magnesium or alkali salts may produce a laxative effect; if not too strong, it is drinkable.
- (4) If the water gags survivors or causes gastric disturbances, drinking should be discontinued.
- (5) The lack of healthy green plants growing around any water source.

b. Because of survivors' potential aversion to water from natural sources, it should be rendered as potable as possible through filtration. Filtration only removes the solid particles from water—it does not purify it. One simple and quick way of filtering is to dig a sediment hole or seepage basin along a water source and allow the soil to filter the water (figure 19-14). The seepage hole should be covered while not in use. Another way is to construct a filter—layers of parachute material stretched across a tripod (figure 19-15). Charcoal is used to eliminate bad odors and foreign materials from the water. Activated charcoal (obtained from freshly burned wood is used to filter the water). If a solid container is available for making a filter, use layers of fine-to-coarse sand and gravel along with charcoal and grass.

c. Purification of water may be done a variety of ways. The method used will be dictated by the situation (such as tactical or nontactical).

- (1) Boil the water for at least 10 minutes.
- (2) To use purification tablets survivors should follow instructions on the bottle. One tablet per quart of clear water; two tablets if water is cloudy. Let water

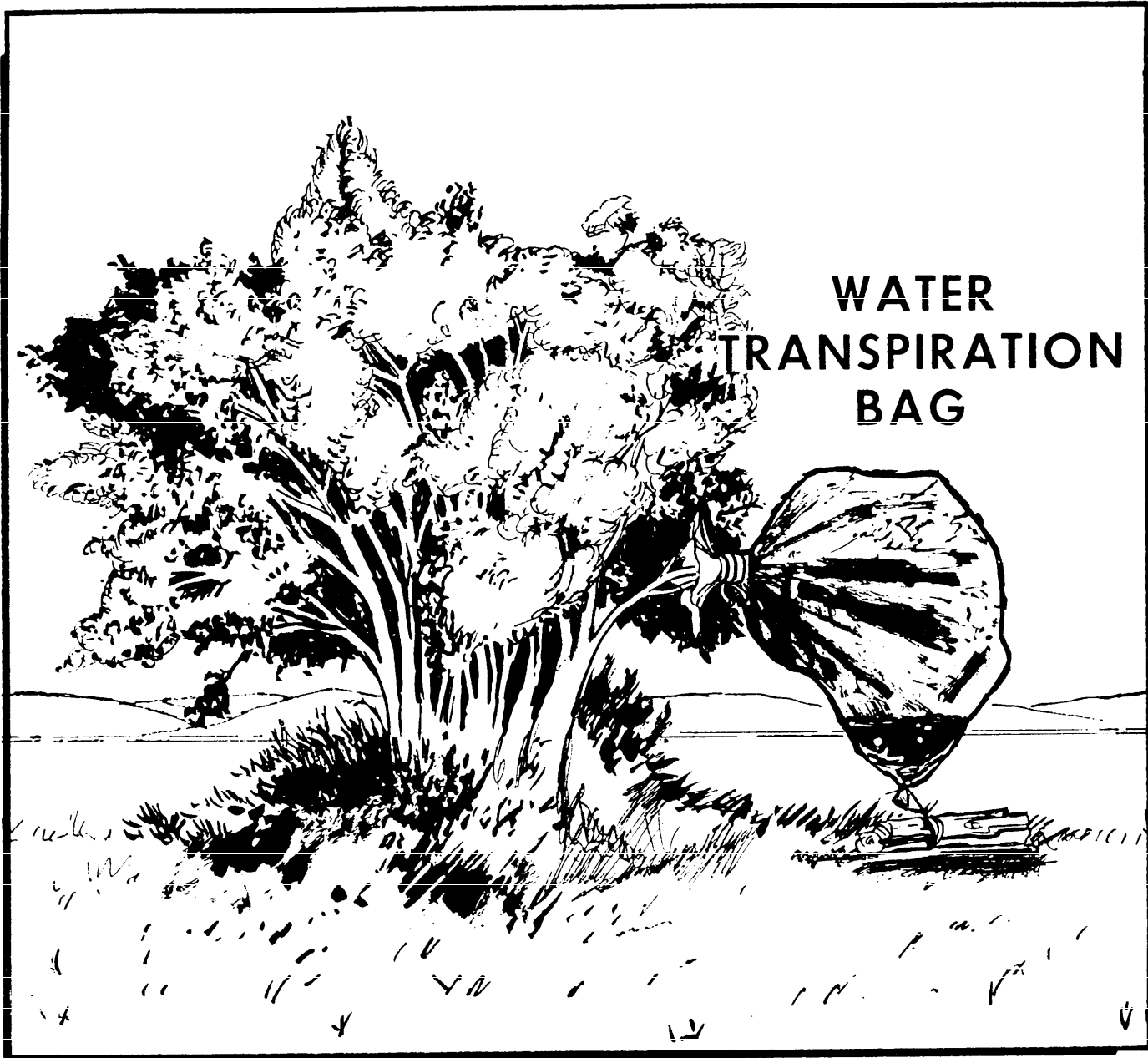

Figure 19-13. Transpiration Bag.

stand for 5 minutes (allowing the tablet time to dissolve), then shake and allow to stand for 15 minutes. Survivors should remember to turn the canteen over and allow a small amount of water to seep out and cover the neck part of the canteen. In an evasion situation, water purification tablets should be used for purifying water. If these are not available, plant sources or non-stagnant, running water obtained from a location upstream from habitatio should be consumed.

(3) Eight drops of 2½-percent iodine per quart—stir or shake and let stand for at least 10 minutes.

d. After water is found and purified, survivors may wish to store it for later consumption. The following make good containers:

- (1) Waterbag.
- (2) Canteen.
- (3) Prophylactic inside a sock for protection of bladder.
- (4) Segment of bamboo.
- (5) Birch bark and pitch canteen.
- (6) LPU bladder.
- (7) Hood from antiexposure suit.

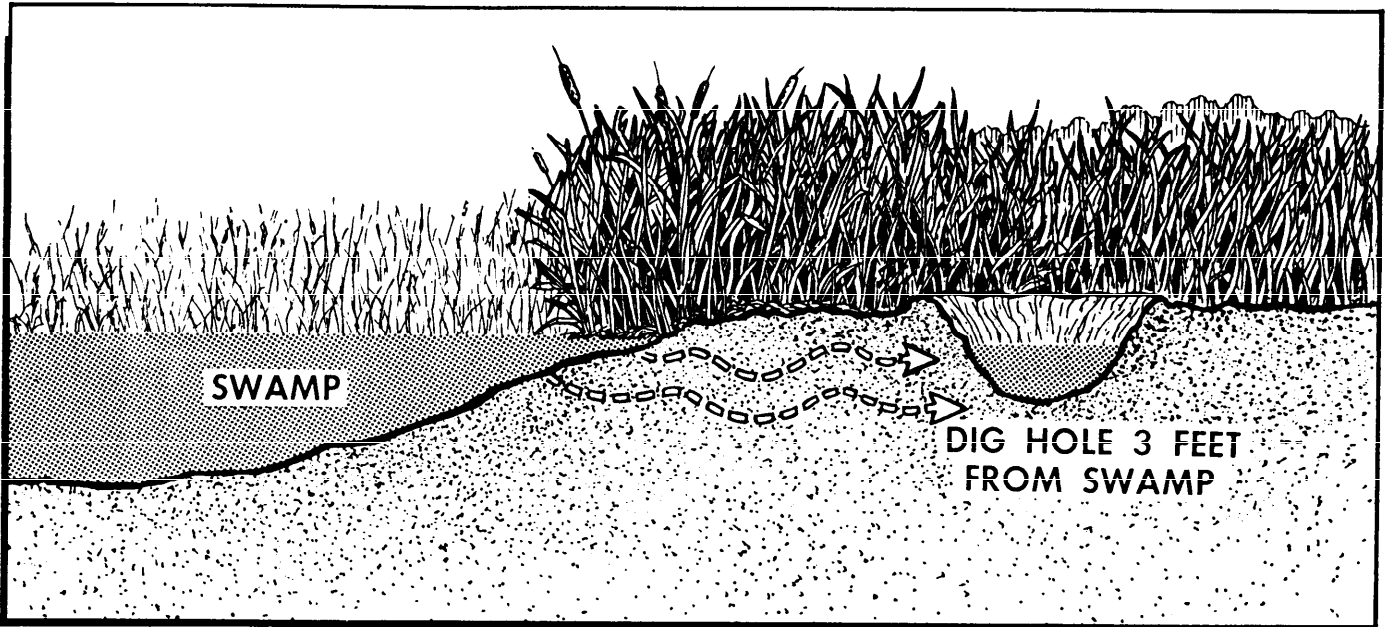

Figure 19-14. Sediment Hole.

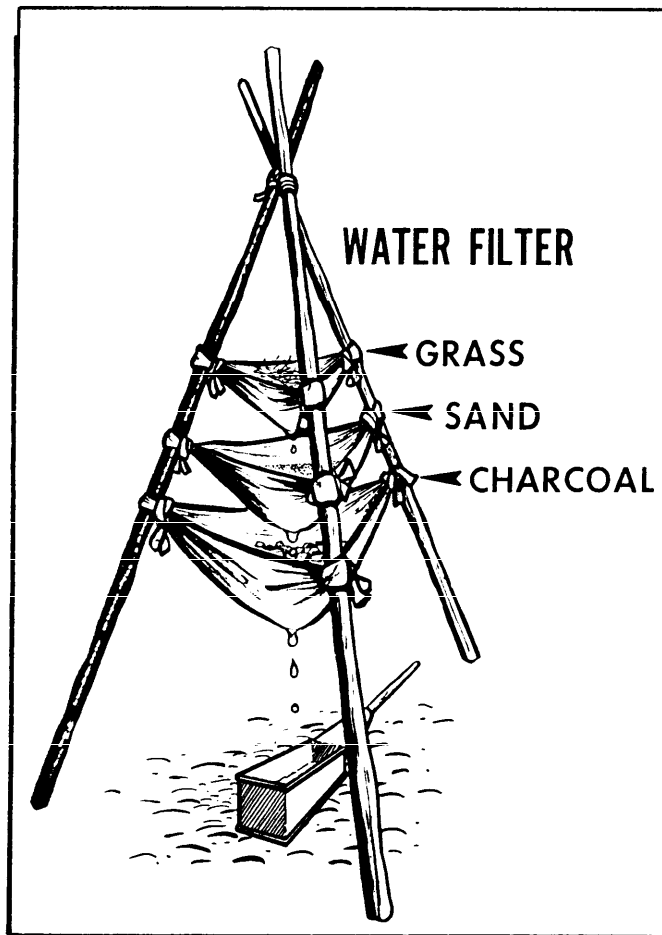

Figure 19-15. Water Filter.

Part Seven

TRAVEL

Chapter 20

LAND NAVIGATION

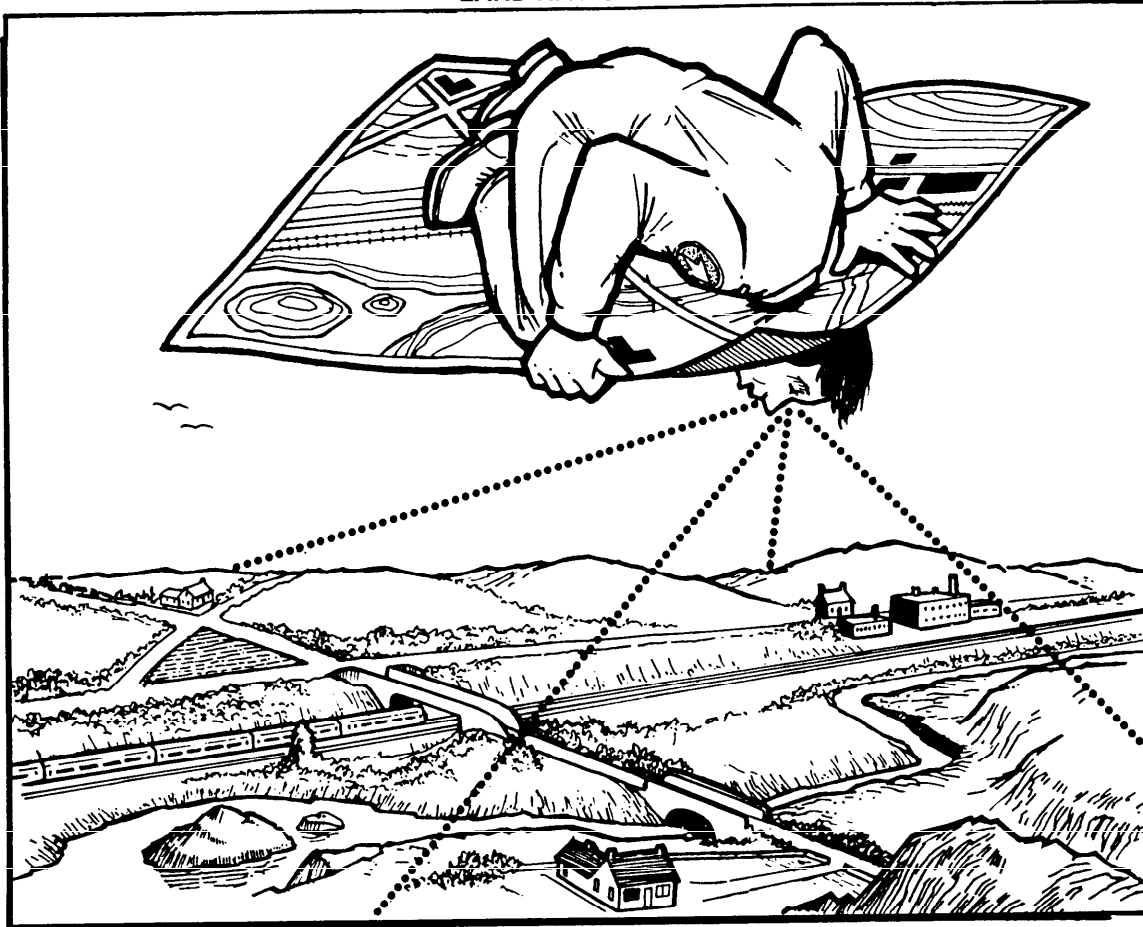

Figure 20-1. Land Nav.

20-1. Introduction:

a. Survivors must know their location in order to intelligently decide if they should wait for rescue or if they should determine a destination and (or) route to travel. If the decision is to stay, the survivors need to know their location in order to radio the information to rescue personnel. If the decision is to travel, survivors must be able to use a map to determine the best routes of travel, location of possible food and water, and hazardous areas which they should avoid.

b. This chapter provides background information in the use of the map and compass (figure 20-1).

20-2. Maps:

a. A map is a pictorial representation of the Earth's surface drawn to scale and reproduced in two dimensions. Every map should have a title, legend, scale, north arrow, grid system, and contour lines. With these

components, survivors can determine the portion of the Earth's surface the map covers. Survivors should be able to understand all of the markings on the map and use them to advantage. They should also be able to determine the distance between any two points on the map and be able to align the map with true north so it conforms to the actual features on the ground.

b. A map is a conceptualized picture of the Earth's surface as seen from above, simplified to bring out important details and lettered for added identification. A map represents what is known about the Earth rather than what can be seen by an observer. However, a map is selective in that only the information which is necessary for its intended use is included on any one map. Maps also include features which are not visible on Earth, such as parallels, meridians, and political boundaries.

c. Since it is impossible to accurately portray a round object, such as the Earth, on a flat surface, all maps have some elements of distortion. Depending on the intended use, some maps sacrifice constant scale for accuracy in measurement of angles, while others sacrifice accurate measurement of angles for a constant scale. However, most maps used for ground navigation use a compromise projection in which a slight amount of distortion is introduced into the elements which a map portrays, but in which a fairly true picture is given.

d. A planimetric map presents only the horizontal positions for the features represented. It is distinguished from a topographic map by the omission of relief in a measurable form.

e. A topographic map (figure 20-2) portrays terrain and landforms in a measurable form and the horizontal positions of the features represented. The vertical positions, or relief, are normally represented by contours. On maps showing relief, the elevations and contours are measured from a specified vertical datum plane and usually mean sea level.

f. A plastic relief map is a reproduction of an aerial photograph or a photomosaic made from a series of aerial photographs upon which grid lines, marginal data, place names, route numbers, important elevations, boundaries, approximate scale, and approximate direction have been added.

g. A PICTOMAP (figure 20-3) is the acronym for photographic image conversion by tonal masking procedures. It is a map on which the photographic imagery of a standard photomap has been converted into interpretable colors and symbols.

h. A photomosaic is an assembly of aerial photographs and is commonly called a mosaic in topographic usage. Mosaics are useful when time does not permit the compilation of a more accurate map. The accuracy of a mosaic depends on the method used in its preparation and may vary from simply a good pictorial effect of the ground to that of a planimetric map.

i. Military city map is a topographic map, usually 1:12,500 scale, of a city, outlining streets and showing street names, important buildings, and other urban elements of military importance which are compatible with the scale of the map. The scales of military city maps can vary from 1:25,000 to 1:5,000, depending on the importance and size of the city, density of detail, and available intelligence information.

j. Special maps are for special purposes such as trafficability, communications, and assault. These are usually overprinted maps of scales smaller than 1:100,000 but larger than 1:1,000,000. Other types of special maps are those made from organosol or materials other than paper to meet the requirements of special climatic conditions.

k. A terrain model is a scale model of the terrain showing landforms, and in large scale models, industrial and cultural shapes. It is designed to provide a means

for visualizing the terrain for planning or indoctrination purposes and for briefing on assault landings.

l. A special purpose map is one that has been designed or modified to give information not covered on a standard map or to elaborate on standard map data. Special purpose maps are usually in the form of an overprint. Overprints may be in the form of individual sheets or combined and bound into a study of an area. A few of the subjects covered are:

- (1) Landform.
- (2) Drainage characteristics.
- (3) Vegetation.
- (4) Climate.
- (5) Coast and landing beaches.
- (6) Railroads.
- (7) Airfields.
- (8) Urban areas.
- (9) Electric power.
- (10) Fuels.
- (11) Surface water resources.
- (12) Ground water resources.
- (13) Natural construction materials.
- (14) Cross-country movement.
- (15) Suitability for airfield construction.
- (16) Airborne operations.

20-3. Aeronautical Charts. Air navigation and planning charts are used for flight planning. Each different series of charts is constructed at a different scale and format to meet the needs of a particular type of air navigation. The air navigation and planning charts are smaller in scale and less detailed than Army maps or air target materials. The control of positional error is less critical. The following list includes the charts most commonly used in intelligence operations. They are available through the Defense Mapping Agency (DMA) Officer of Distribution Services, Washington DC. A description of each chart follows the listing:

CHART	SCALE	CODE
USAF Global Navigation and Planning Chart	1:5,000,000	GNC
USAF Jet Navigation Chart	1:3,000,000	JNC-A
USAF Operational Navigation Chart	1:1,000,000	ONC
USAF Tactical Pilotage Chart	1:500,000	TPC
USAF Jet Navigation Chart	1:2,000,000	JN
Joint Operations Graphic	1:250,000	JOG

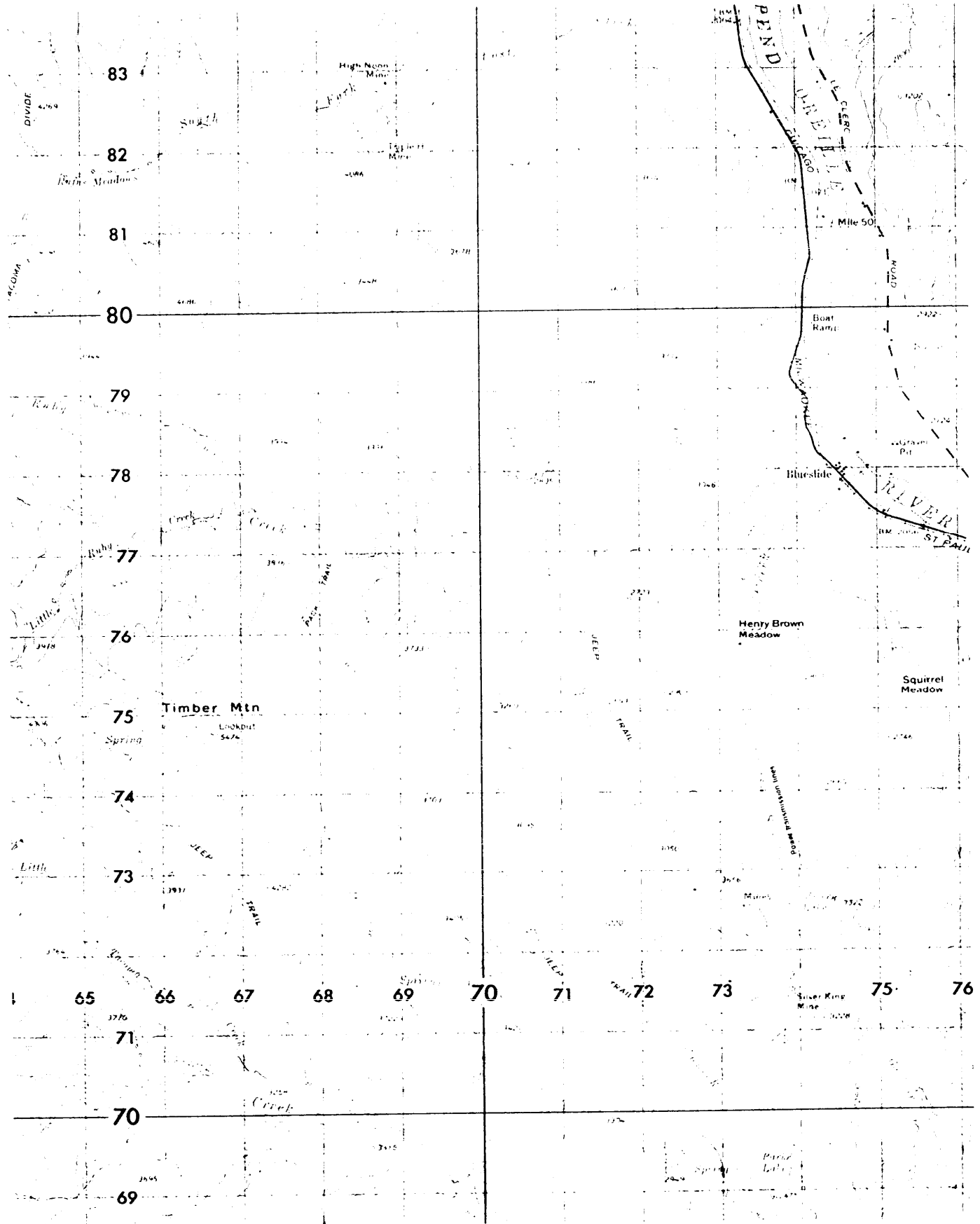

Figure 20-2. Topographic Map.

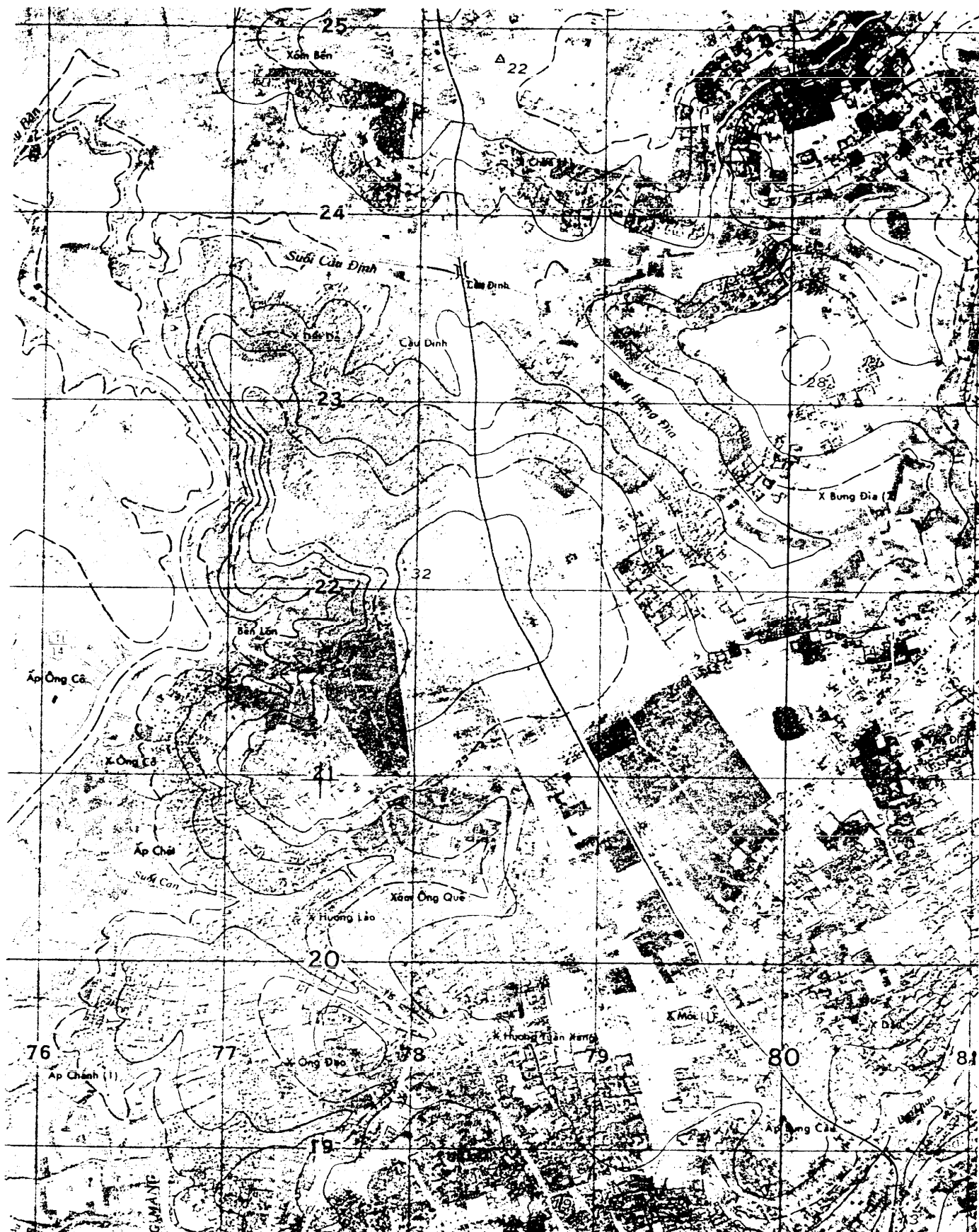

Figure 20-3. Pictomap.

a. Global Navigation and Planning Chart (GNC) (figure 20-4). This chart is designed for general planning purposes where large areas of interest and long-distance operations are involved. It serves as a navigation chart for long-range, high-altitude, and high-speed aircraft since sheet lines have been selected on the basis of primary areas of strategic interest. Several other general planning charts are available through the DMA. Some of these charts are produced on selected areas of strategic interest; others provide wide coverage. All general planning charts are produced at a small or very small scale which provides extensive area coverage on a single sheet.

b. USAF Jet Navigation Chart (JN/JNC-A) (figure 20-5). The basic JNC is produced at a scale of 1:2,000,000. The JNC-A is produced on the north polar area and in the United States at a scale of 1:3,000,000. Both jet navigation charts are printed on 41½- by 57¾-inch sheets.

(1) The JN chart is used for preflight planning and en route navigation by long-range jet aircraft with dead reckoning, radar, celestial, and grid navigational capabilities. The charts are designed so they can be joined to produce a strip chart which provides the necessary navigational information for any intended course. Relief is indicated through the use of contours, spot elevations, and gradient tints. Large, level terrain areas are indicated by a symbol that consists of narrow, parallel lines with the elevation annotated within the symbol.

(2) Principal cities and towns and principal roads and rail networks are shown on the JN chart. The transportation network is shown in the immediate area of populated places. Lakes and principal drainage patterns are also pictured. The elevations of major lakes are indicated so that the altitude may be determined by using the aircraft radar altimeter.

c. USAF Operational Navigation Chart (ONC) (figure 20-6):

(1) The ONC was developed to meet military requirements for a chart adaptable to low-altitude navigation. The ONC is used for preflight planning and en route navigation. It is also used for operational planning, intelligence briefing and plotting, and flight planning displays.

(2) This chart covers an area of 8° of latitude and 12° of longitude. ONC sheets are identified by combining a letter and a number (figure 20-7). Letters identify 8° bands of latitude, starting at the North Pole and progressing southward. Numbers identify 12° sections of longitude from the prime meridian eastward. The successful execution of low-altitude mission depends upon visual and radar identification of ground features used as checkpoints and a rapid visual association of these features with their chart counterparts. The ONC portrays, by conventional signs and symbols, cultural features which have low-altitude checkpoint signifi-

cance. Powerlines are shown (except on cities) and are indicated by the usual line and pole symbol.

(3) For certain circumstances, operational requirements may be more effectively satisfied by pictorial illustrations than by the conventional symbolization of such structures as prominent buildings, bridges, dams, towers, holding or storage tanks, stadiums, and related features. For these reasons, significant landmarks are depicted on ONCs by pictorial symbols.

(4) The ONC portrays relief in perspective so that the user gets instantaneous appreciation of relative heights, slope gradients, and the forms of ground patterns. Topographic expression, illustrated basically with contours and spot elevations, is emphasized by the use of shaded relief and terrain characteristic tints defining the overall elevation levels. ONC contour intervals and terrain characteristic tints are selected regionally. This captures the relative significance of ground forms as a complete picture, and this feature aids preflight planning and in-flight identification.

d. USAF Tactical Pilotage Chart (TPC) (figure 20-8):

(1) The TPC is produced in a coordinated series at a scale of 1:500,000. Sheet sizes are the same dimensions as the ONC sheets; however, a TPC covers only one-fourth as much area as an ONC sheet. The TPC breakdown on the ONC is illustrated in figure 20-9. A TPC is identified by the ONC identification and the letter "A," "B," "C," or "D."

(2) The TPC is used for detailed preflight planning and mission analysis. In designing the TPC, emphasis was placed on ground features which are significant for low-level, high-speed navigation, using visual and radar means. The selected ground features also permit immediate ground-chart orientation at predetermined checkpoints.

(3) Relief on the TPC is displayed by contours (intervals may vary between 100 feet and 1,000 feet), spot elevations, relief shading, and terrain characteristic tints. Cultural features such as towns and cities, principal roads, railroads, power transmission lines, boundaries, and other features of value for low-altitude visual missions are included on the TPC. Pictorial symbols are used for features which provide the best checkpoints. Other features of the TPC which enhance its tactical air navigation qualities are as follows:

- (a) UTM grid overprint.
- (b) Vegetation color and symbol code.
- (c) Enlarged vertical obstruction symbols.
- (d) Enlarged road and railroad symbols.
- (e) Emphasized radio aid to navigation symbols.
- (f) Foreign place name glossary.
- (g) Airdrome runway patterns to scale when information is available.
- (h) Spot elevation, gradient tints, and shaded relief depicted for all elevations.
- (i) The highest elevation for each 15-minute quadrangle is shown in thousands and hundreds of feet.

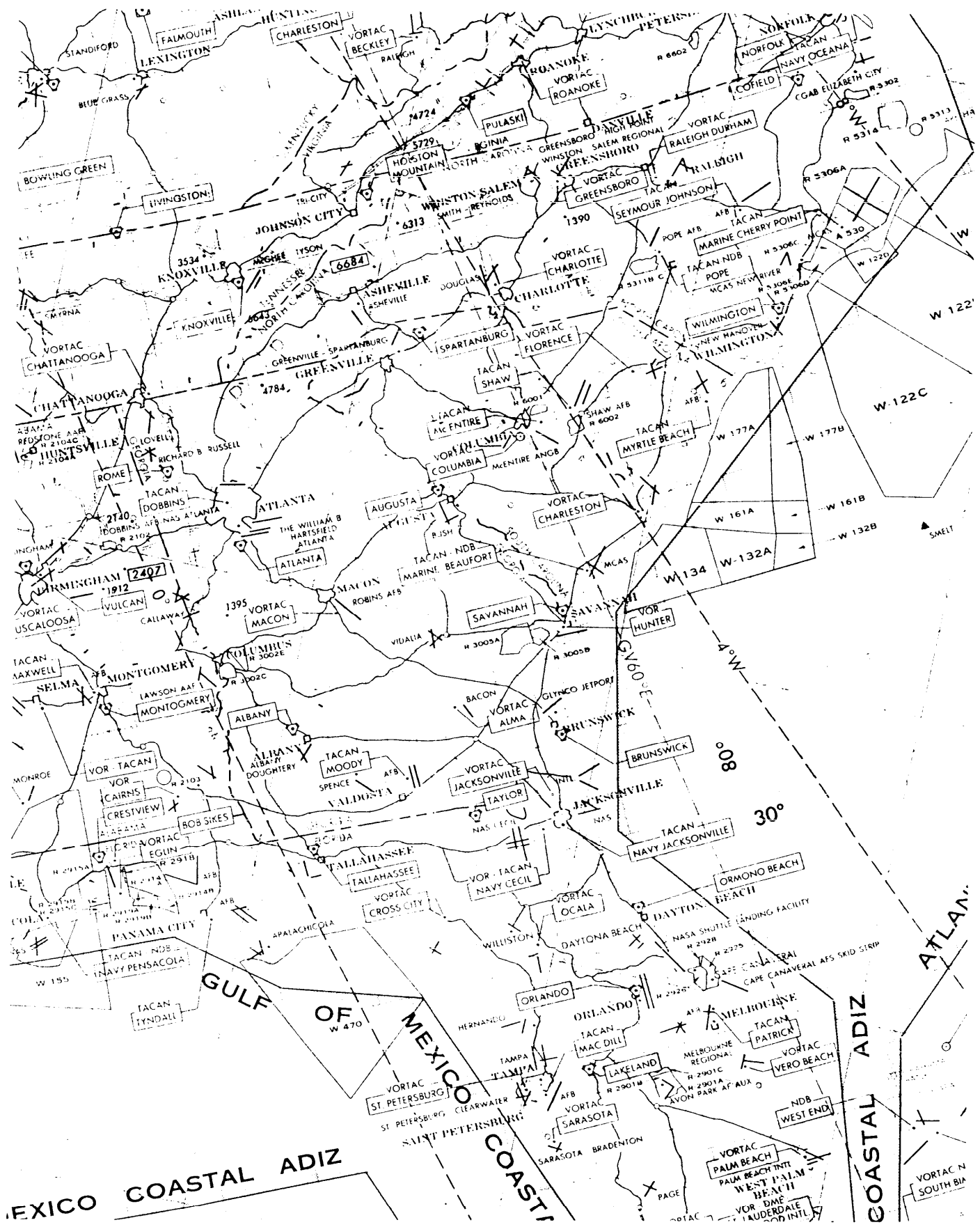

Figure 20-4. GNC Map.

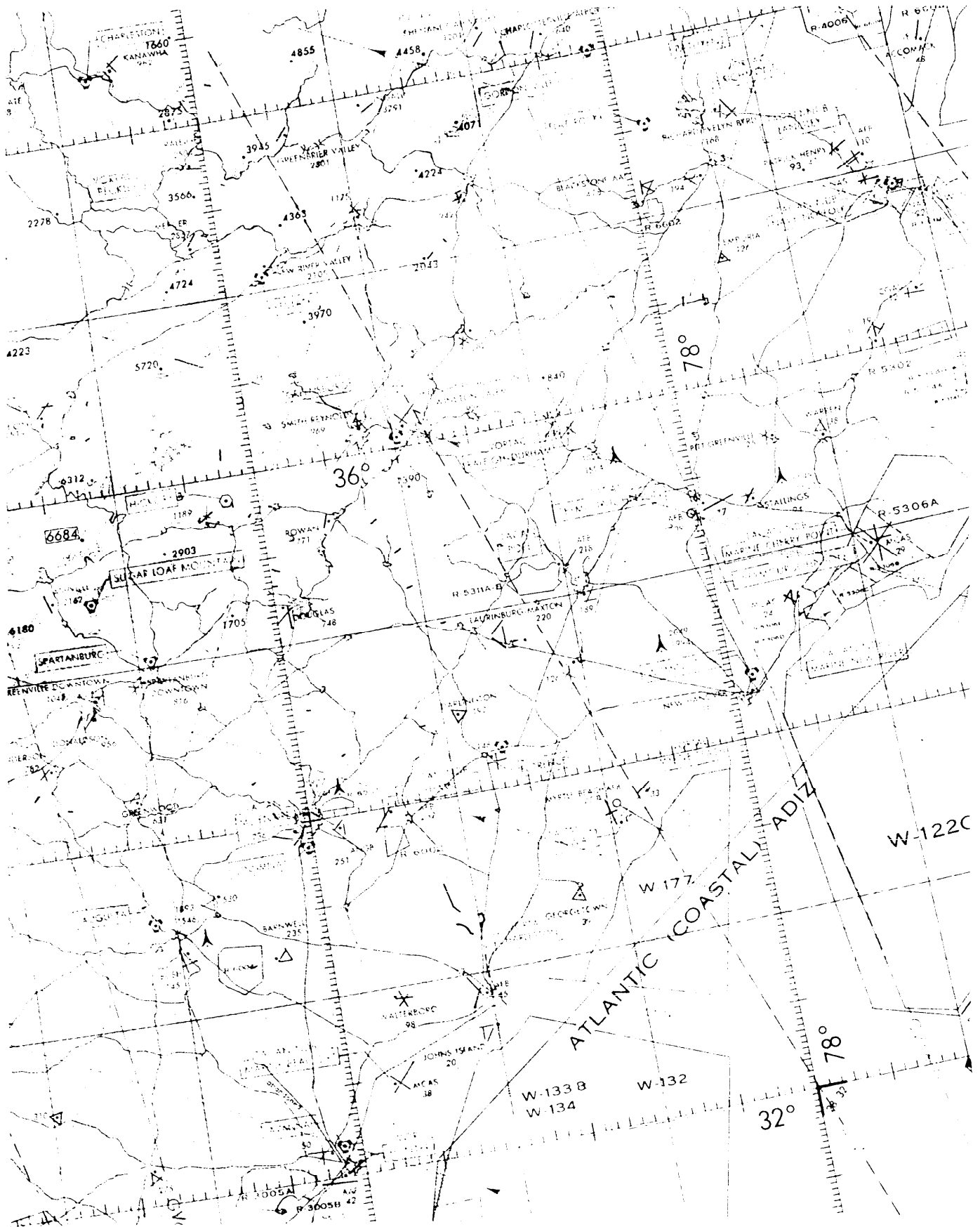

Figure 20-5. JNC Map.

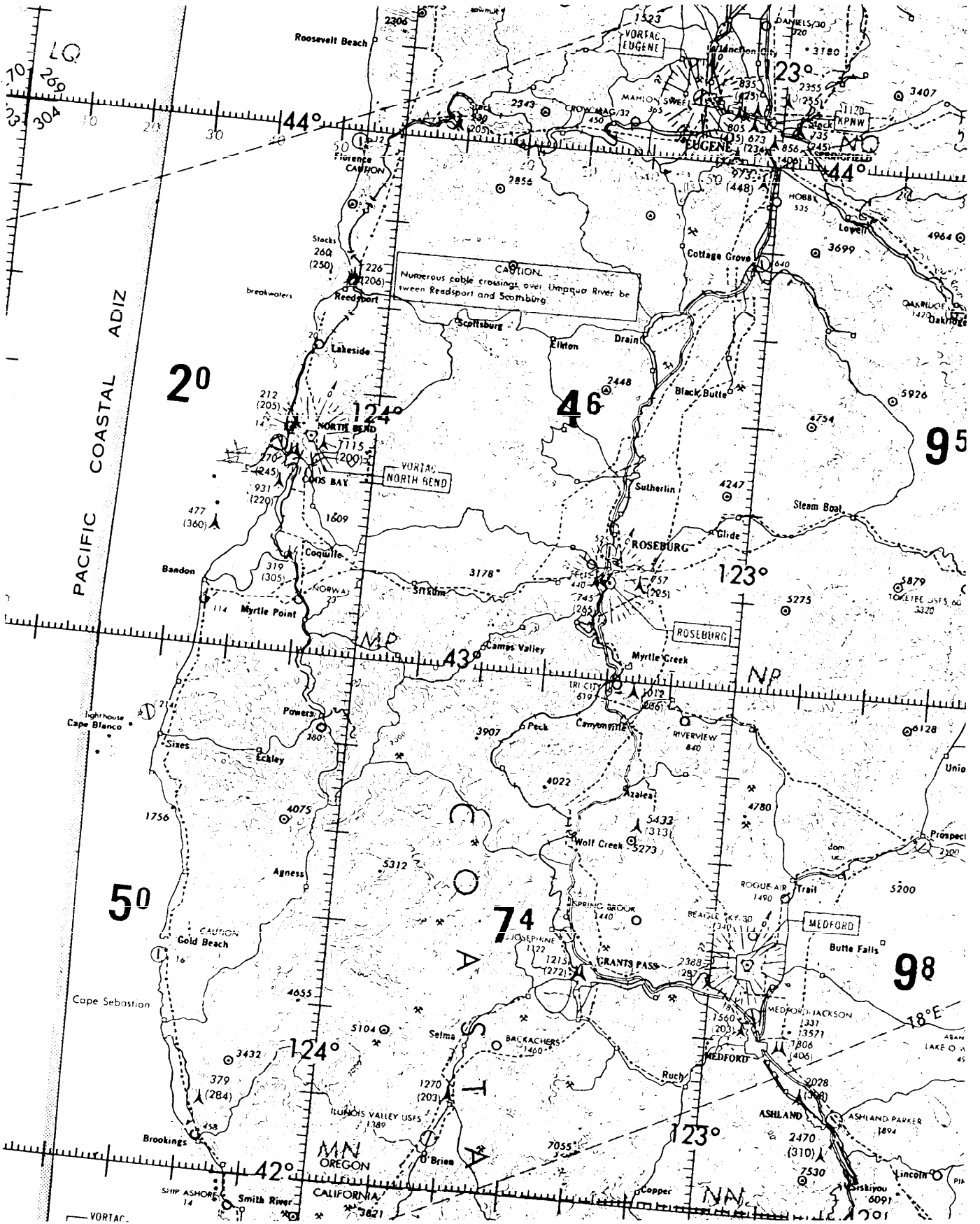

Figure 20-6. ONC Map.

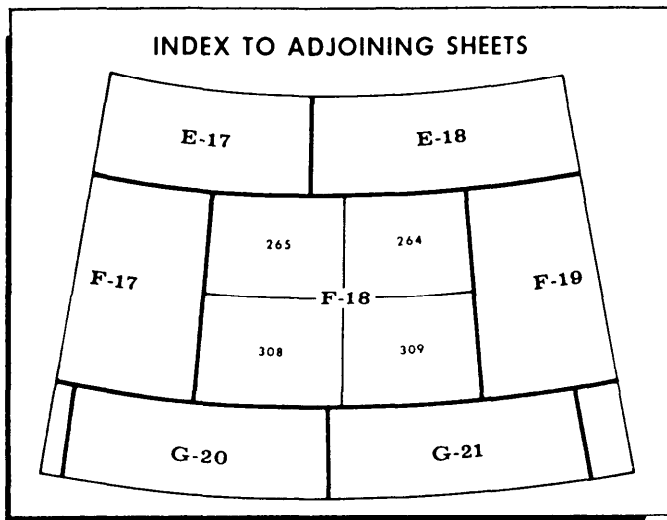

Figure 20-7. Operational Navigation Chart Index.

e. Joint Operations Graphic (JOG) (Series 1501 AIR):

(1) JOGs (figure 20-10) are series of 1:250,000 scale military maps designed for joint ground and air operations. The maps are published in ground and air editions. Both series emphasize the air-landing facilities but the air series has additional symbols to identify aids and obstructions to air navigation.

(2) JOG was designed to provide a common-scale graphic for Army, Navy, and Air Force use. Air Forces make use of it for tactical air operations, close air support, and interdiction by medium- and high-speed aircraft at low altitudes. The chart may also be used for dead reckoning and visual pilotage for short-range en route navigation. Due to its large scale, it is unsuitable for local area command planning for strategic and tactical operations.

(a) Relief on the JOG is indicated by contour lines (in feet). In some areas, the intervals may be in meters, with the approximate value in feet indicated in the margin of the chart. Spot elevations are used through all terrain levels. The ground series show elevations and contours in meters while the air series show the same elevations and contours in feet.

(b) Relief is also shown through gradient tints, supplemented by shaded relief. The highest elevations in each 15-minute quadrangle are indicated in thousands and hundreds of feet.

(c) Cultural features, such as cities, towns, roads, trails, and railroads are illustrated in detail. The locations of boundaries and power transmission lines are also shown. Vegetation is shown by symbol. Detailed drainage patterns and water tint are used to illustrate water features, such as coastlines, oceans, lakes, rivers and streams, canals, swamps, and reefs. The JOG includes aeronautical information such as airfields, fixed

radio navigation and communication facilities, and all known obstructions over 200 feet above ground. If the information is available, the airfield runway patterns are shown to scale by diagram.

(d) The basic numbering system of the JOG consists of two letters and a number which identifies an area 6° in longitude by 4° in latitude. If the chart covers an area north of the Equator, the first letter is "N;" a chart covering an area south of the Equator is identified with an initial "S." The second letter identifies the 4° bands of latitude lettered north and south from the Equator. The number identifies the 6° sections of longitude which are numbered from the 180° meridian eastward. The $6^\circ \times 4^\circ$ areas identified by two letters and a number from 1 to 60 are further broken down to either 12 or 16 sheets. Figure 20-11 illustrates how the sheets are numbered in each breakdown. The figure also indicates the respective latitudes at which the 12- and 16-sheet breakdown is used. Charts produced in Canada use a slightly different sheet identification system. The DOD Aeronautical Chart Catalog contains an explanation of the system.

f. DOD Evasion Charts (Figure 20-12). The Defense Mapping Agency and Aeronautical Chart and Information Center prepare DOD evasion charts. The Korea and Southeast Asia charts have been completed. The scale for these charts is 1:250,000. The charts have both longitude and latitude and the UTM grid coordinate systems. The relief is duplicated by both contour lines and shading. The magnetic variation is shown by a compass rose superimposed on the chart. The charts also indicate the direction of seasonal ocean currents. These charts may include geographic environmental data consisting of a description of the people, climate, water, food, hazards, and vegetation. A conversion of elevation bar scale may aid in communicating with other forces. The star chart is provided to aid in night navigation.

20-4. Information Contained in Margin:

a. Before using any piece of equipment, a wise operator always reads the manufacturer's book of instructions. This is also true with maps. The instructions are placed around the outer edges of the map and are known as marginal information. All maps are not the same, so it becomes necessary each time a different map is used to carefully examine the marginal information.

b. Figure 20-13 is a large-scale (1:50,000) topographic map. The circled numbers indicate the marginal information with which the map user must be familiar. The location of the marginal information will vary with each different type of map. However, the following items are on most maps. The circled numbers correspond to the item numbers listed and described below.

(1) Sheet Name (1). The sheet name is in two places; the center of the upper margin and the right side of the lower margin. Generally, a map is named after its

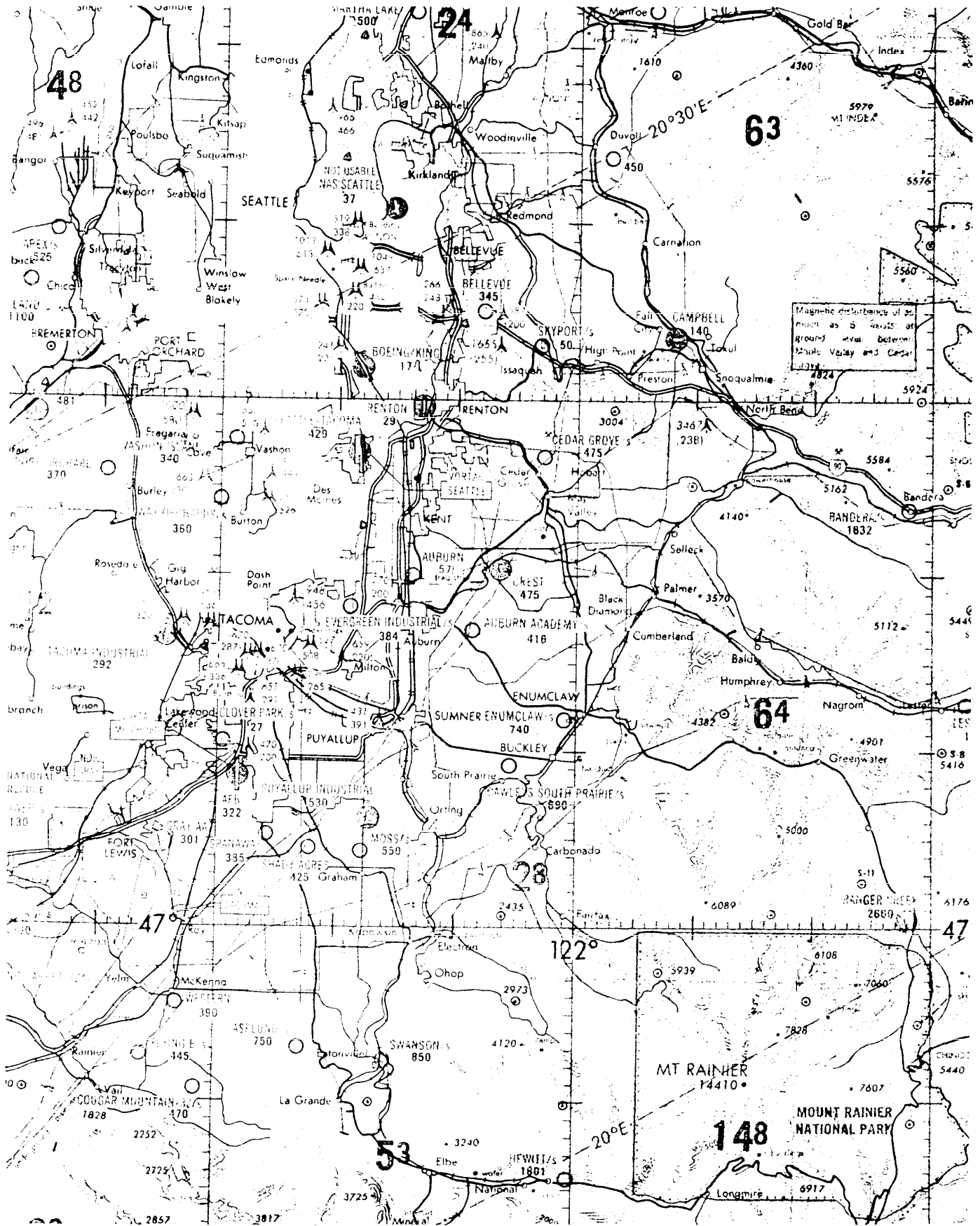

Figure 20-8. TPC Map.

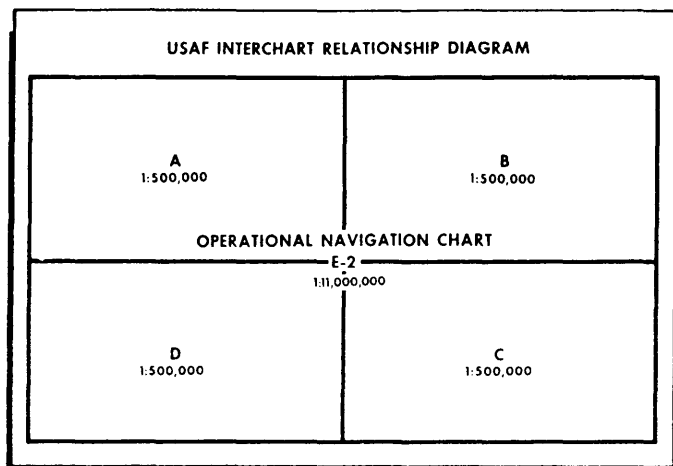

Figure 20-9. Relationship of TPC and ONC.

outstanding cultural or geographic feature. When possible, the name of the largest city on the map is used (not shown).

(2) Sheet Number (2). The sheet number is in the upper right margin and is used as a reference number for that map sheet. For maps at 1:100,000 scale and larger, sheet numbers are based on an arbitrary system which makes possible the ready orientation of maps at scales of 1:100,000, 1:50,000, and 1:25,000 (figures 20-14 and 20-15).

(3) Series Name and Scale (3):

(a) The map series name is in the upper left margin. A map series usually comprises a group of similar maps at the same scale and on the same sheet lines or format designed to cover a particular geographic area. It may also be a group of maps which serve a common purpose, such as military city maps. The name given a series is of the most prominent area. The scale note is a representative fraction which gives the ratio of map distance to the corresponding distance on the Earth's surface. For example, the scale note 1:50,000 indicates that one unit of measure on the map equals 50,000 units of the same measure on the ground.

(b) Scale. The scale is expressed as a fraction and gives the ratio of map distance to ground distance. The terms "small scale," "medium scale," and "large scale" may be confusing when read with the numbers. However, if the number is viewed as a fraction, it quickly becomes apparent the 1:600,000 of something is smaller than 1:75,000 of the same thing. Hence, the larger the number after 1:, the smaller the scale of the map.

-1. Small Scale. Maps at scales of 1:600,000 and smaller are used for general planning and strategical studies at the high echelons. The standard small scale is 1:1,000,000.

-2. Medium Scale. Maps at scales larger than 1:600,000 but smaller than 1:75,000 are used for plan-

ning operations, including the movement and concentration of troops and supplies. The standard medium scale is 1:250,000.

-3. Large Scale. Maps at scales of 1:75,000 and larger are used to meet the tactical, technical, and administrative needs of field units. The standard large scale is 1:50,000.

(4) Series Number (4). The series number appears in the upper right margin and the lower left margin. It is a comprehensive reference expressed either as a four-digit numeral (example, 1125), or as a letter, followed by a three- or four-digit numeral (example, V7915).

(5) Edition Number (5). The edition number is in the upper margin and lower left margin. It represents the age of the map in relation to other editions of the same map and the agency responsible for its production. The latest edition will have the highest number. EDITION 1 DMATC indicates the first edition prepared by the Defense Mapping Agency Topological Center. Edition numbers run consecutively; a map bearing a higher edition number is assumed to contain more recent information than the same map bearing a lower edition number. Advancement of the edition number constitutes authority to rescind or supersede the previous edition.

(6) Bar Scales (6). The bar scales are located in the center of the lower margin. They are rulers used to convert map distance to ground distance. Maps normally have three or more bar scales, each a different unit of measure.

(7) Credit Note (7). The credit note is in the lower left margin. It lists the producer, dates, and general methods of preparation or revision. This information is important to the map user in evaluating the reliability of the map as it indicates when and how the map information was obtained. On some recent 1:50,000 scale maps, the map credits are shown in tabular form in the lower margin, with reliability information presented in a coverage diagram.

(8) Adjoining Sheets Diagram (8) (not shown). Maps at all standard scales contain a diagram which illustrates the adjoining sheets.

(a) On maps at 1:100,000 and larger scales and at 1:1,000,000 scales, the diagram is called the Index to Adjoining Sheets, and consists of as many rectangles, representing adjoining sheets, as are necessary to surround the rectangle which represents the sheet under consideration. The diagram usually contains nine rectangles, but the number or names may vary depending on the location of the adjoining sheets. All represented sheets are identified by their sheet numbers. Sheets of an adjoining series, whether published or planned, that are the same scale are represented by dashed lines. The series number of the adjoining series is indicated along the appropriate side of the division line between the series (figure 20-16).

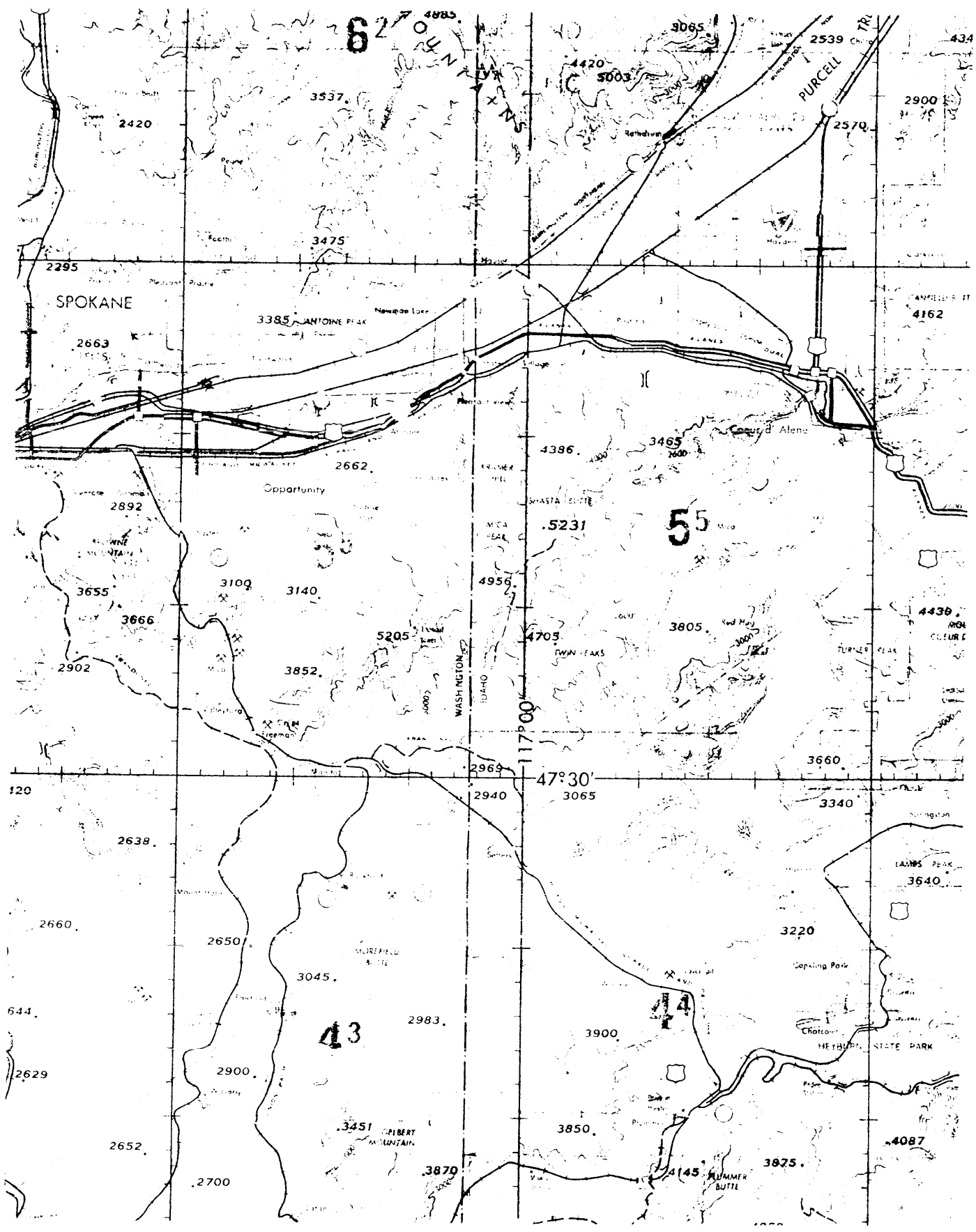

Figure 20-10. Joint Operations Graphics Map.

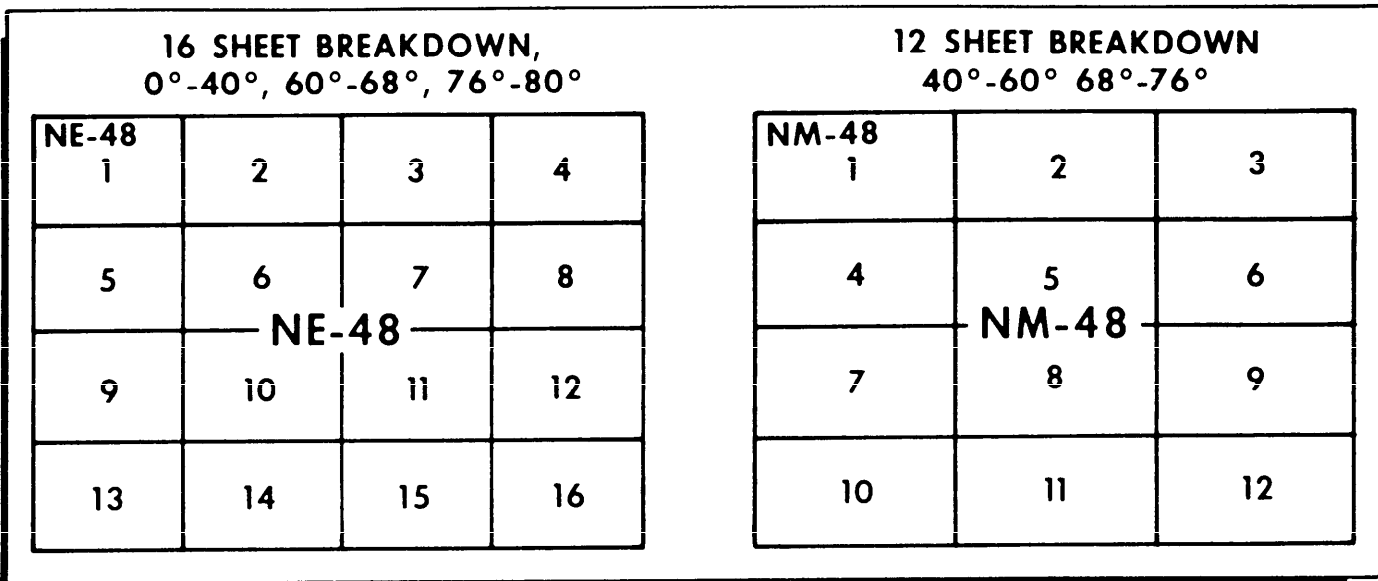

Figure 20-11. JOG Sheet Numbering System.

(b) On 1:50,000 scale maps, the sheet number and series number of the 1:250,000 scale map of the area are shown below the Index to Adjoining Sheets.

(c) On maps at 1:250,000 scale, the adjoining sheets are shown in the location diagram. Usually, the diagram consists of 25 rectangles, but the number may vary with the locations of the adjoining sheets.

(9) Index to Boundaries (9). The index to boundaries diagram appears in the lower right margin of all sheets 1:100,000 scale or larger, and 1:1,000,000 scale. This diagram, which is a miniature of the map, shows the boundaries which occur within the map area, such as county lines and state boundaries. On 1:250,000 scale maps, the boundary information is included in the location diagram.

(10) Projection Note (10). The projection system is the framework of the map. For maps, this framework is the conformal type; that is, small areas of the surface of the Earth retain their true shapes on the projection, measured angles closely approximate true values, and the scale factor is the same in all directions from a point. The projection is identified on the map by a note in the lower margin.

(11) Grid Note (11). The grid note is in the center of the lower margin. It gives information pertaining to the grid system used, the interval of grid lines, and the number of digits omitted from the grid values. Notes pertaining to overlapping or secondary grids are also included when appropriate.

(12) Grid Reference Box (12). The grid reference box has instructions for composing a grid reference.

(13) Vertical Datum Note (13). This note is in the center of the lower margin. It designates the basis for all

vertical control stations, contours, and elevations appearing on the map. On JOGs at 1:250,000 scale, the vertical datum note may appear in the reliability diagram.

(14) Horizontal Datum Note (14). This note is located in the center of the lower margin. It indicates the basis for all horizontal control stations appearing on the map. This network of stations controls the horizontal positions of all mapped features. On JOGs at 1:250,000 scale, the horizontal datum note may appear in the reliability diagram.

(15) Legend (15). The legend is located in the lower left margin. It illustrates and identifies the topographic symbols used to depict some of the more prominent features on the map. The symbols are not always the same on every map. To avoid error in the interpretation of symbols, the legend must always be referred to when a map is read.

(16) Declination Diagram (16). The declination diagram is usually located in the lower margin of large-scale maps and indicates the angular relationships of true north, grid north, and magnetic north. On maps at 1:250,000 scale, this information is expressed as a note in the lower margin.

(17) User's Note (17). A user's note is in the center of the lower margin. It requests cooperation in correcting errors or omissions on the map. Errors should be marked and the map forwarded to the agency identified in the note.

(18) Unit Imprint (18). The unit imprint, in the lower left margin, identifies the agency which printed the map and the printing date. The printing date should

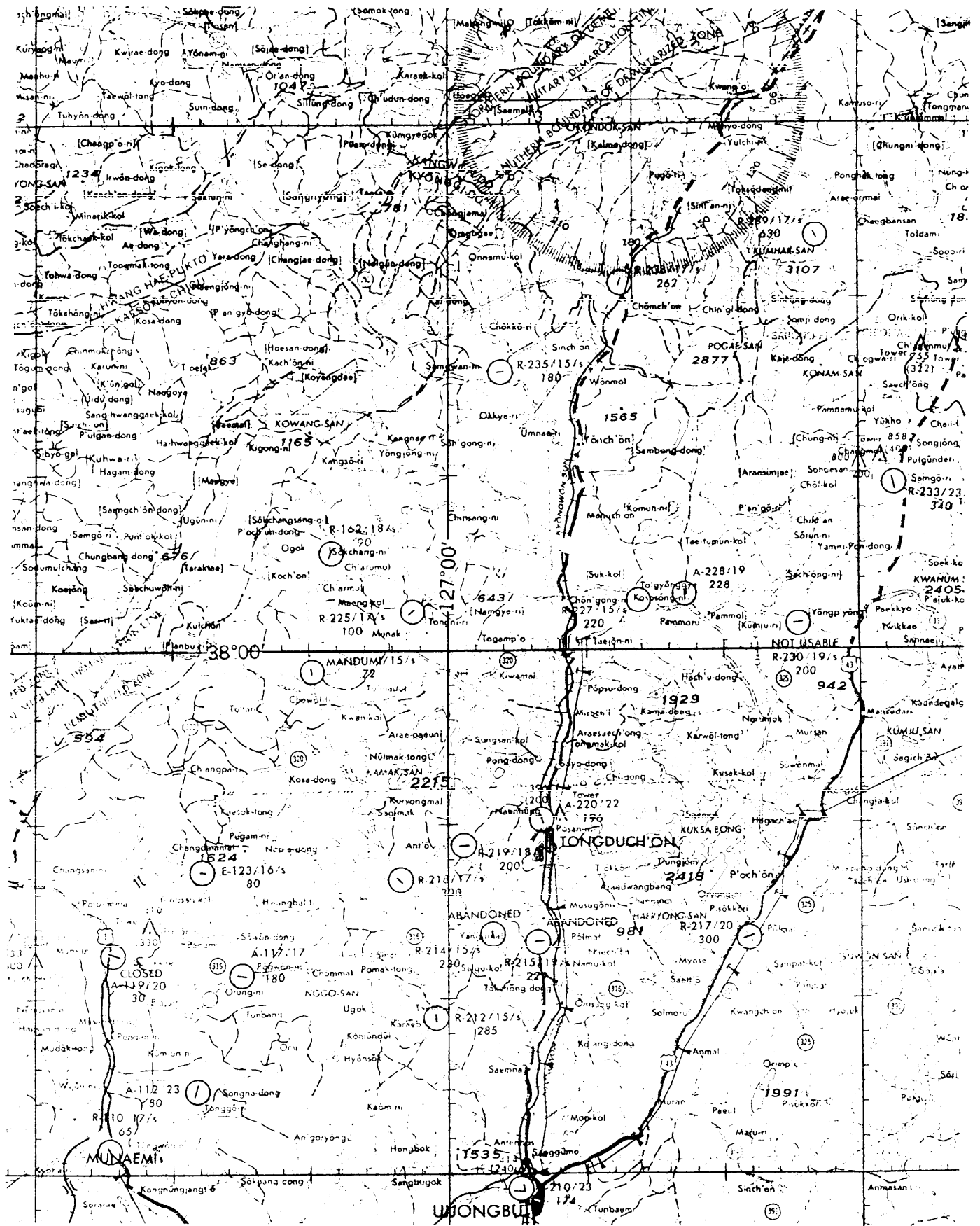

Figure 20-12. DOD Evasion Chart.

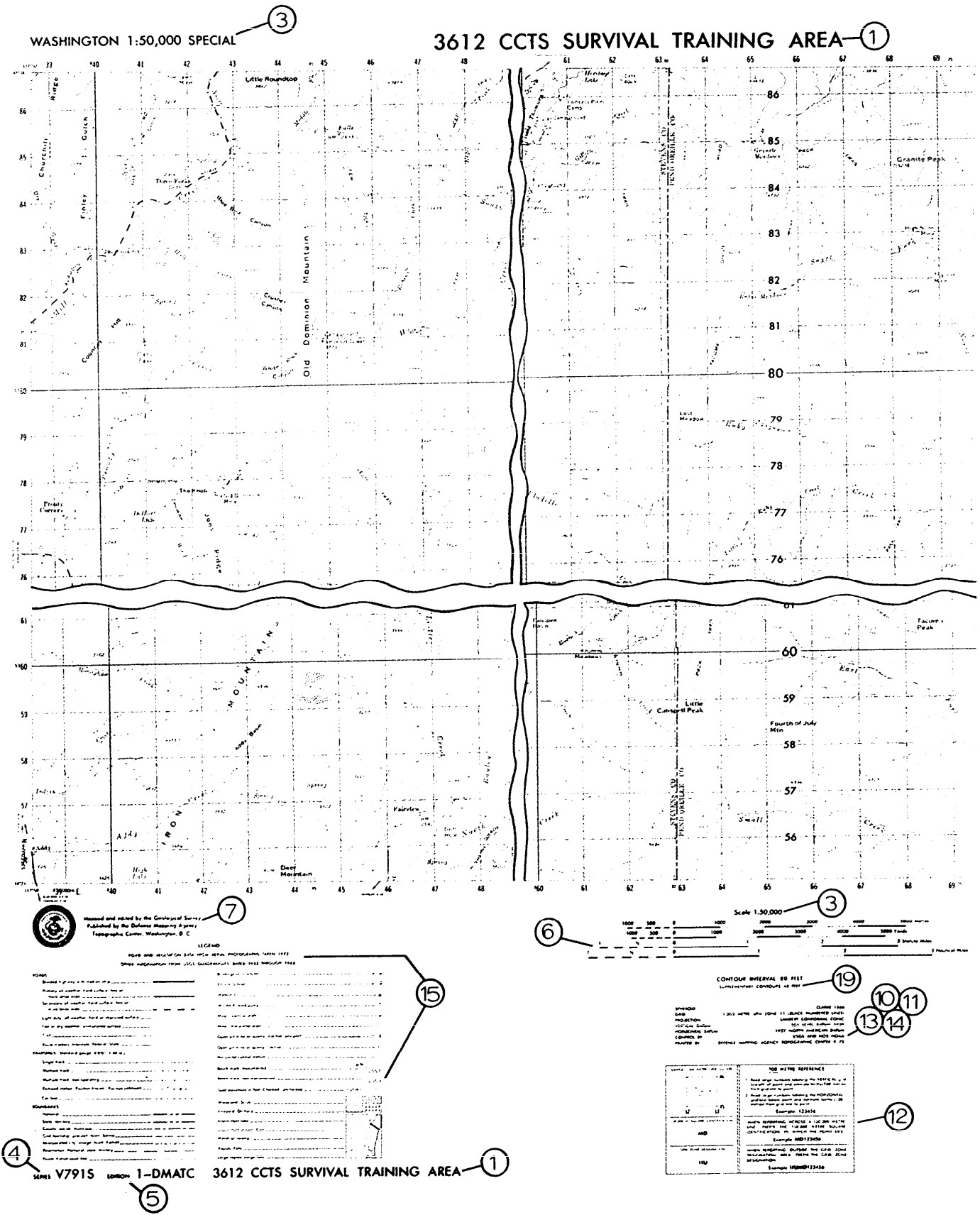
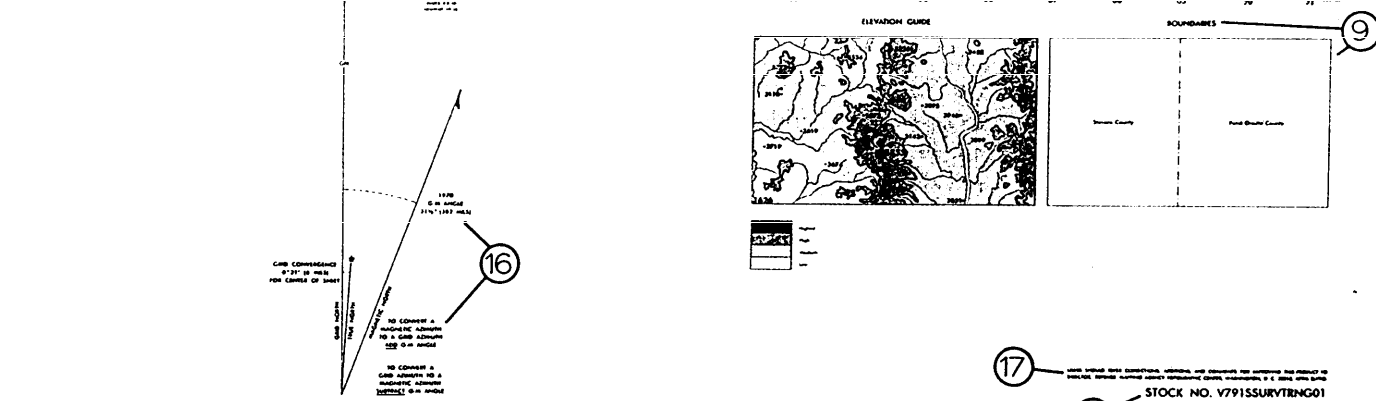
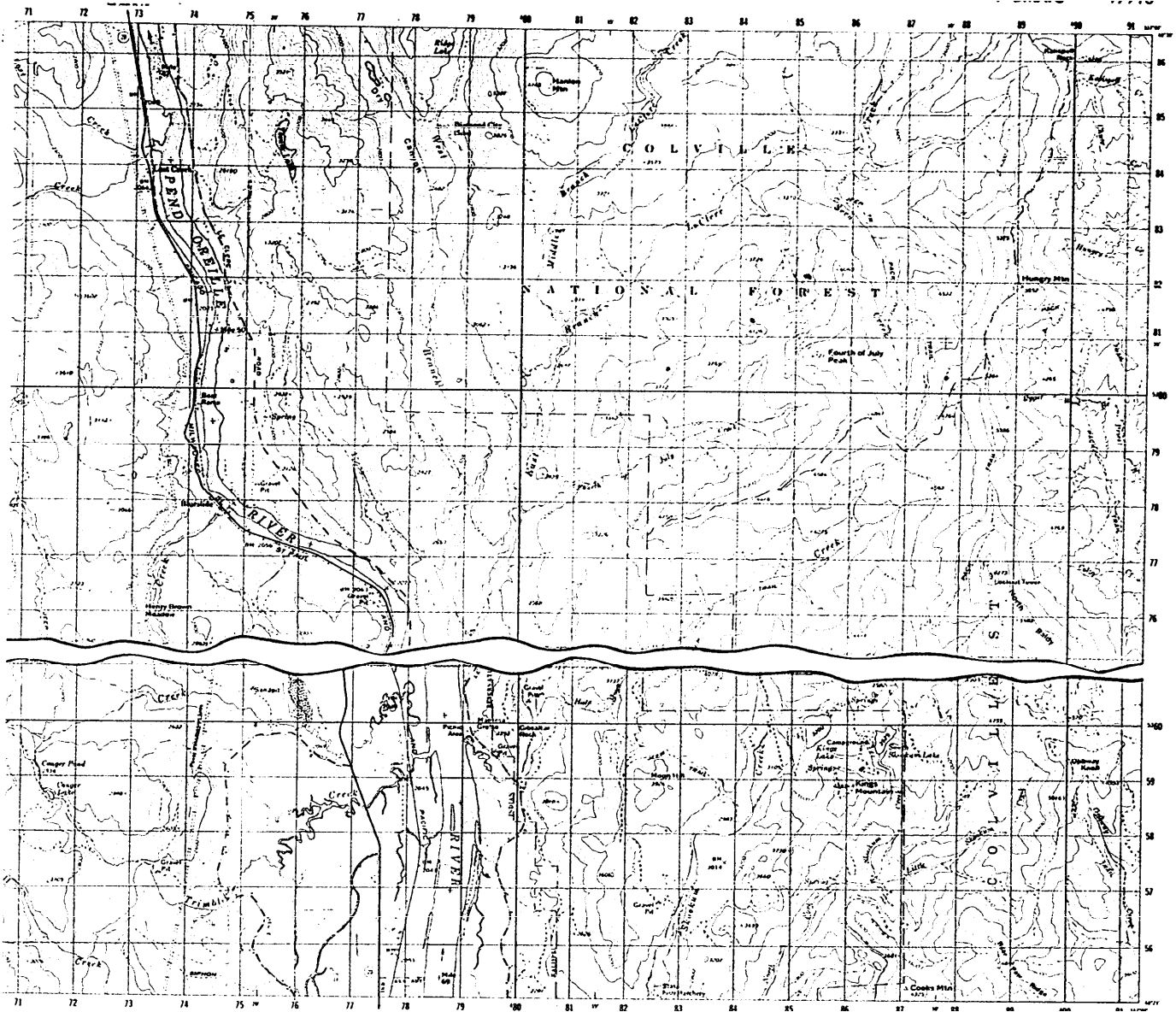

Figure 20-13. 1:50,000 Topographic Map.

5 SECTION 1-DMATC SERIES V791S 4



16

CAMP CONVERSIONS
 4731' IN 1951
 FOR CAMPERS OF 1951

NO CONVERSION A
 MAGNETIC ANGLE
 10 x G.M. ANGLE
 100 0 IN ANGLE

NO CONVERSION A
 CAMP ANGLE NO A
 MAGNETIC ANGLE
 10000 0 IN ANGLE

17

STOCK NO. V791SURVTRNG01

2

Figure 20-13. 1:50,000 Topographic Map. (continued)

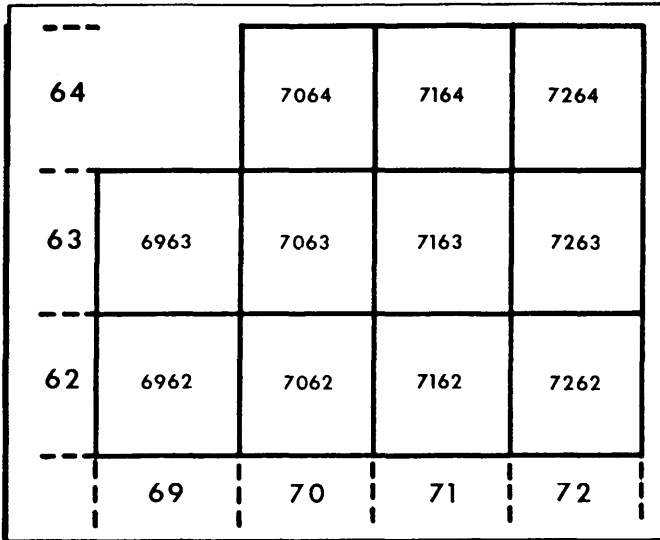

Figure 20-14. Basic Development, 1:100,000 Scale.

not be used to determine when the map information was obtained.

(19) Contour Interval (19). The contour interval note appears in the center of the lower margin. It states the vertical distance between adjacent contour lines on the map. When supplementary contours are used, the interval is indicated.

(20) Special Notes and Scales (20). Under certain conditions, special notes or scales may be added to the margin information to aid the map user. The following are examples:

(a) Glossary. A glossary is an explanation of technical terms or a translation of terms on maps of foreign areas where the native language is other than English.

(b) Classification. Certain maps require a note indicating the security classification. This is shown in the upper and lower margins.

(c) Protractor Scale. A protractor scale may appear in the upper margin on some maps. It is used to lay out the magnetic grid declination of the map which, in turn, is used to orient the map sheet with the aid of a magnetic compass.

(d) Coverage Diagram. A coverage diagram may be used on maps at scales of 1:100,000 and larger. It is normally in the lower or right margin and indicates the methods by which the map was made, dates of photography, and reliability of the sources. On maps at 1:250,000 scale, the coverage diagram is replaced by a reliability diagram.

(e) Elevation Guide. On some maps at scales of 1:100,000 and larger, a miniature characterization of the terrain is shown by a diagram in the lower right margin of the map. The terrain is represented by bands of elevation, spot elevations, and major drainage fea-

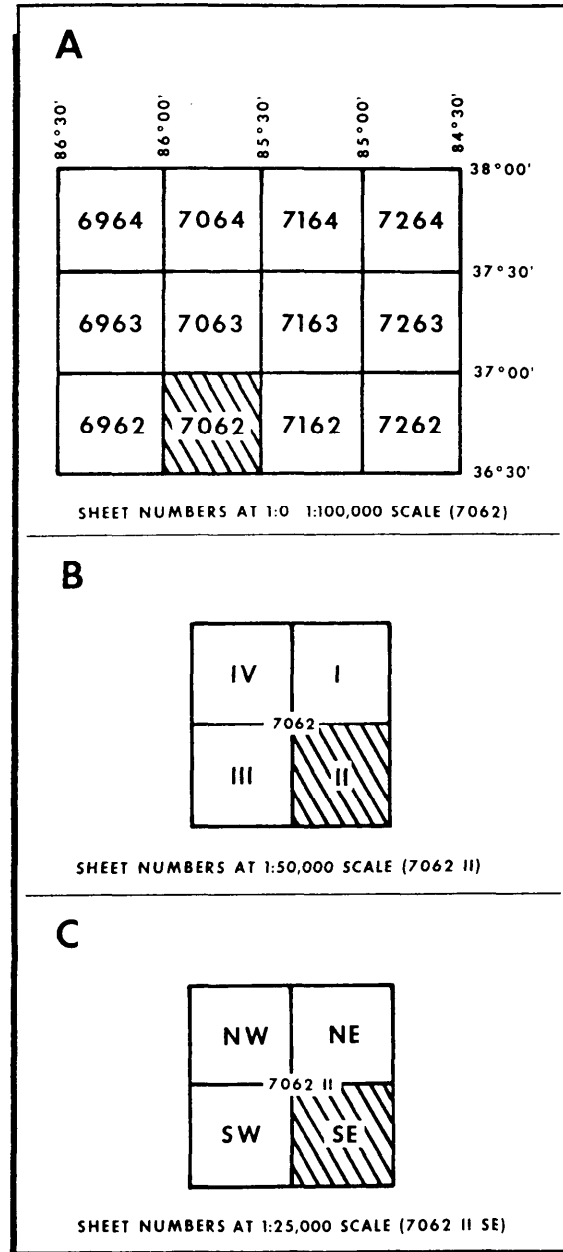

Figure 20-15. Systems for Numbering Maps.

tures. The elevation guide provides the map reader with a means of rapid recognition of major landforms.

(f) Special Notes. A special note is any statement of general information that relates specifically to the mapped area. For example, rice fields are generally subject to flooding; however, they may be seasonally dry.

(21) Stock Number Identification (21). All maps published by or for the Department of the Army or Defense Mapping Agency contain stock number identifications which are used in requisitioning map supplies. The identification consists of the words "STOCK NO." followed by a unique designation which is composed of the series number, the sheet number of the individual

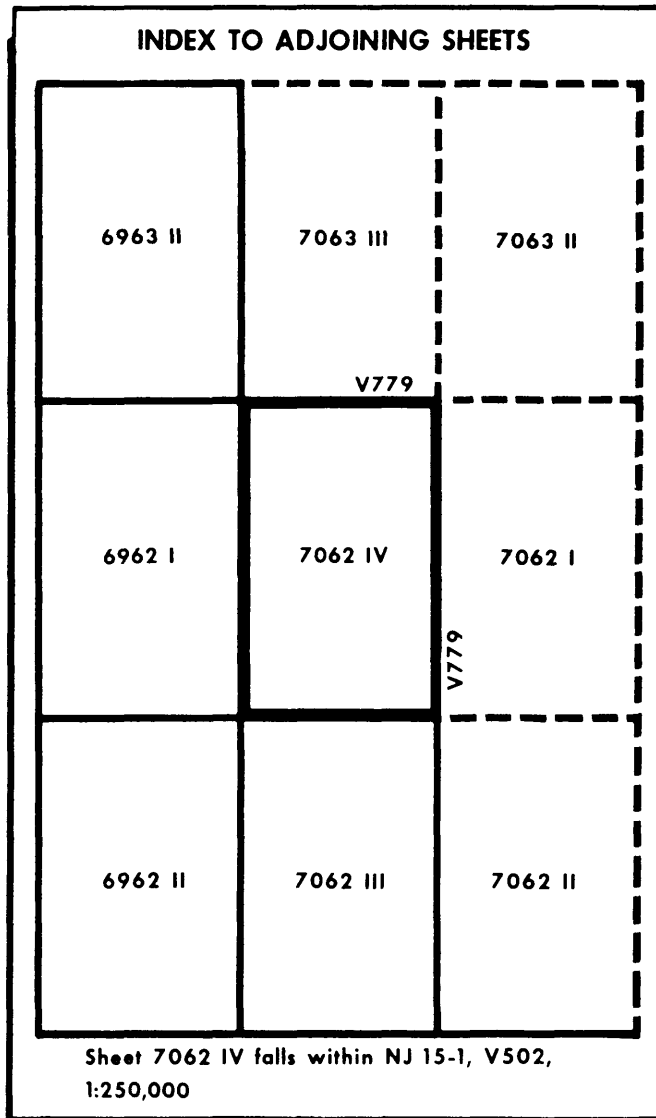

Figure 20-16. Index to Adjoining Sheets.

map, and on recently printed sheets, the edition number.

20-5. Topographic Map Symbols and Colors:

a. The purpose of a map is to permit one to visualize an area of the Earth's surface with pertinent features properly positioned. Ideally, all the features within an area would appear on the map in their true proportion, position, and shape. This, however, is not practical because many of the features would be unimportant and others would be unrecognizable because of their reduction in size. The mapmaker has been forced to use symbols to represent the natural and manmade features of the Earth's surface. These symbols resemble, as closely as possible, the actual features as viewed from above (figures 20-17 and 20-18).

b. To facilitate identification of features on the map by providing more natural appearance and contrast, the topographic symbols are usually printed in different colors, with each color identifying a class of features. The colors vary with different types of maps, but on a standard large-scale topographic map, the colors used and the features represented are:

(1) Black—the majority of cultural or manmade features.

(2) Blue—water features such as lakes, rivers, and swamps.

(3) Green—vegetation such as woods, orchards, and vineyards.

(4) Brown—all relief features such as contours.

(5) Red—main roads, built-up areas, and special features.

(6) Occasionally, other colors may be used to show special information. (These, as a rule, are indicated in the marginal information. For example, aeronautical symbols and related information for air-ground operations are shown in purple on JOGs.)

c. In the process of making a map, everything must be reduced from its size on the ground to the size which appears on the map. For purposes of clarity, this requires some of the symbols to be exaggerated. They are positioned so that the center of the symbol remains in its true location. An exception to this would be the position of a feature adjacent to a major road. If the width of the road has been exaggerated, then the feature is moved from its true position to preserve its relation to the road.

d. Army Field Manual 21-31 gives a description of topographic symbols and abbreviations authorized for use on US military maps. Figure 20-19 illustrates several of the symbols used on maps.

20-6. Coordinate Systems. The intersections of reference lines help to locate specific points on the Earth's surface. Three of the primary reference line systems are the geographic coordinate system, the reference (GEOREF) system, and the universal transverse mercator grid system (UTM). Knowing how to use these plotting systems should help a survivor to determine point locations.

a. Coordinates. Quantities that give position with respect to two reference lines are called coordinates. Thus, the intersection of F Street and 4th Avenue (figure 20-20) is the coordinate location of the Gridville Public Library. The coordinates of the local theater are D Street and 6th Avenue. One can see from this simplified example that coordinates are read at intersections of vertical and horizontal lines. The basic coordinate system used on maps and charts is the geographic military grid. The structure and use of the geographic coordinate system, the world geographic reference system, and the military grid reference system will be discussed and illustrated.

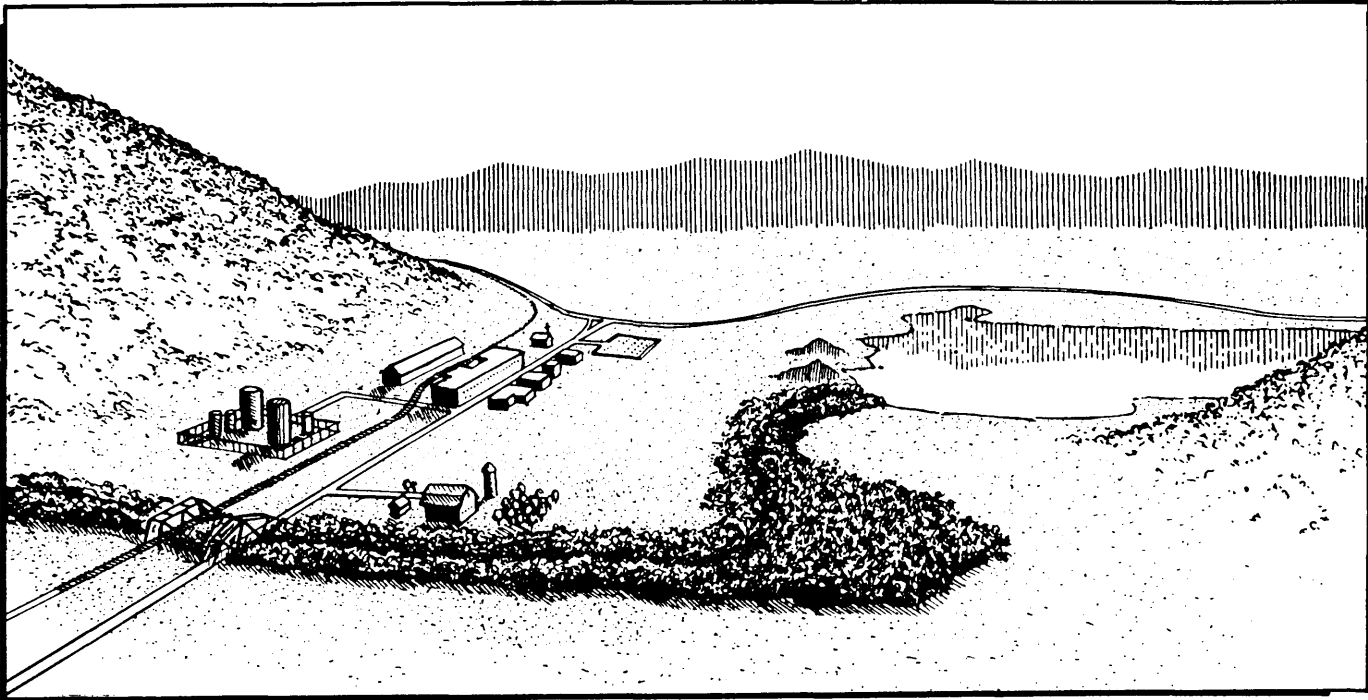

Figure 20-17. Area Viewed from Ground Position.

(1) Geographic Coordinates. The geographic coordinate system is a network of imaginary lines that circle the Earth. They are used to express Earth position or

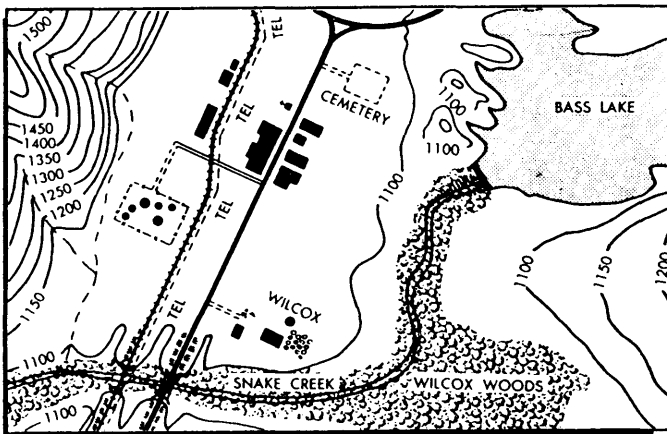

Figure 20-18. Area Viewed from Ground Position—Map.

location. There are north-south lines called meridians of longitude and east-west lines named parallels of latitude. The location of any point on the Earth can be expressed in terms of the intersection of the line of latitude and the line of longitude passing through the point.

(2) Meridians of Longitude. The lines of latitude and longitude are actually great and small circles

formed by imaginary planes cutting the Earth. A great circle divides the Earth into two equal parts (halves); whereas, a small circle divides the Earth into two unequal parts. Study figure 20-21 and note that: (1) each north-south line is a great circle, and (2) each great circle passes through both the North and South Poles. Each half of each of these great circles from one pole, in either direction, to the other pole is called a meridian of longitude. The other half of the same great circle is a second meridian of longitude.

(a). Meridian is derived from the Latin word "meridianum," which means "lines that pass through the highest point on their course" (in this case, both the North and South Poles). Any angular distance measured east or west of the meridian is called longitudinal distance; hence, the term "meridian of longitude." It is necessary, of course, to assign values to the meridians to make them meaningful. The most appropriate values to use for circles are degrees ($^{\circ}$), minutes ($'$), and seconds ($''$). Circles are customarily divided into 360° per circle, $60'$ per degree, and $60''$ per minute.

(b). All meridians are equal in value; hence, one of them must be assigned the value of 0° (the starting point). The meridian passing through Greenwich, England, is zero degrees (0°). This meridian is also called the prime meridian (figure 20-22). The other half of the great circle on which the prime meridian is located is designated the 180th meridian. Portions of this meridian are also called the international dateline.

TOPOGRAPHIC MAP SYMBOLS

VARIATIONS WILL BE FOUND ON OLDER MAPS

<p>Primary highway, hard surface </p> <p>Secondary highway, hard surface </p> <p>Light-duty road, hard or improved surface </p> <p>Unimproved road </p> <p>Road under construction, alinement known </p> <p>Proposed road </p> <p>Dual highway, dividing strip 25 feet or less </p> <p>Dual highway, dividing strip exceeding 25 feet </p> <p>Trail </p> <hr/> <p>Railroad: single track and multiple track </p> <p>Railroads in juxtaposition </p> <p>Narrow gage: single track and multiple track </p> <p>Railroad in street and carline </p> <p>Bridge: road and railroad </p> <p>Drawbridge: road and railroad </p> <p>Footbridge </p> <p>Tunnel: road and railroad </p> <p>Overpass and underpass </p> <p>Small masonry or concrete dam </p> <p>Dam with lock </p> <p>Dam with road </p> <p>Canal with lock </p> <hr/> <p>Buildings (dwelling, place of employment, etc.) </p> <p>School, church, and cemetery </p> <p>Buildings (barn, warehouse, etc.) </p> <p>Power transmission line with located metal tower </p> <p>Telephone line, pipeline, etc. (labeled as to type) </p> <p>Wells other than water (labeled as to type) Oil Gas</p> <p>Tanks: oil, water, etc. (labeled only if water) Water</p> <p>Located or landmark object, windmill </p> <p>Open pit, mine, or quarry; prospect </p> <p>Shaft and tunnel entrance </p> <hr/> <p>Horizontal and vertical control station:</p> <p>Tablet, spirit level elevation BM Δ 565.1</p> <p>Other recoverable mark, spirit level elevation Δ 5455</p> <p>Horizontal control station: tablet, vertical angle elevation VABM Δ 95/9</p> <p>Any recoverable mark, vertical angle or checked elevation Δ 37.75</p> <p>Vertical control station: tablet, spirit level elevation BM X 957</p> <p>Other recoverable mark, spirit level elevation X 954</p> <p>Spot elevation x 7369 x 7,69</p> <p>Water elevation 670</p>	<p>Boundaries: National </p> <p>State </p> <p>County, parish, municipio </p> <p>Civil township, precinct, town, barrio </p> <p>Incorporated city, village, town, hamlet </p> <p>Reservation, National or State </p> <p>Small park, cemetery, airport, etc. </p> <p>Land grant </p> <p>Township or range line, United States land survey </p> <p>Township or range line, approximate location </p> <p>Section line, United States land survey </p> <p>Section line, approximate location </p> <p>Township line, not United States land survey </p> <p>Section line, not United States land survey </p> <p>Found corner: section and closing </p> <p>Boundary monument: land grant and other </p> <p>Fence or field line </p> <hr/> <p>Index contour </p> <p>Supplementary contour </p> <p>Fill </p> <p>Levee </p> <p>Mine dump </p> <p>Tailings </p> <p>Shifting sand or dunes </p> <p>Sand area </p> <p>Intermediate contour </p> <p>Depression contours </p> <p>Cut </p> <p>Levee with road </p> <p>Wash </p> <p>Tailings pond </p> <p>Intricate surface </p> <p>Gravel beach </p> <hr/> <p>Perennial streams </p> <p>Elevated aqueduct </p> <p>Water well and spring </p> <p>Small rapids </p> <p>Large rapids </p> <p>Intermittent lake </p> <p>Foreshore flat </p> <p>Sounding, depth curve </p> <p>Exposed wreck </p> <p>Rock, bare or awash; dangerous to navigation </p> <p>Intermittent streams </p> <p>Aqueduct tunnel </p> <p>Glacier </p> <p>Small falls </p> <p>Large falls </p> <p>Dry lake bed </p> <p>Rock or coral reef </p> <p>Piling or dolphin </p> <p>Sunken wreck </p> <hr/> <p>Marsh (swamp) </p> <p>Wooded marsh </p> <p>Woods or brushwood </p> <p>Vineyard </p> <p>Land subject to controlled inundation </p> <p>Submerged marsh </p> <p>Mangrove </p> <p>Orchard </p> <p>Scrub </p> <p>Urban area </p>
--	--

Figure 20-19. Topographic Map Symbols.

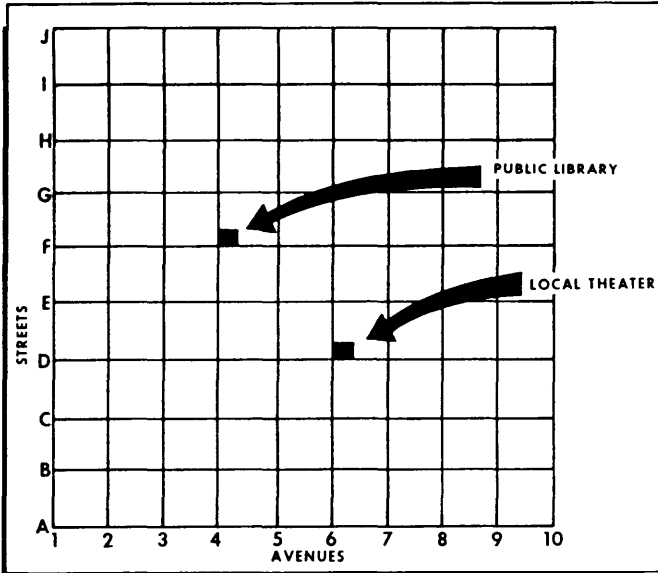

Figure 20-20. Gridville City.

(c). From the prime meridian east of the international dateline, meridians are assigned values of 0° through 180° east. Similarly, from the prime meridian

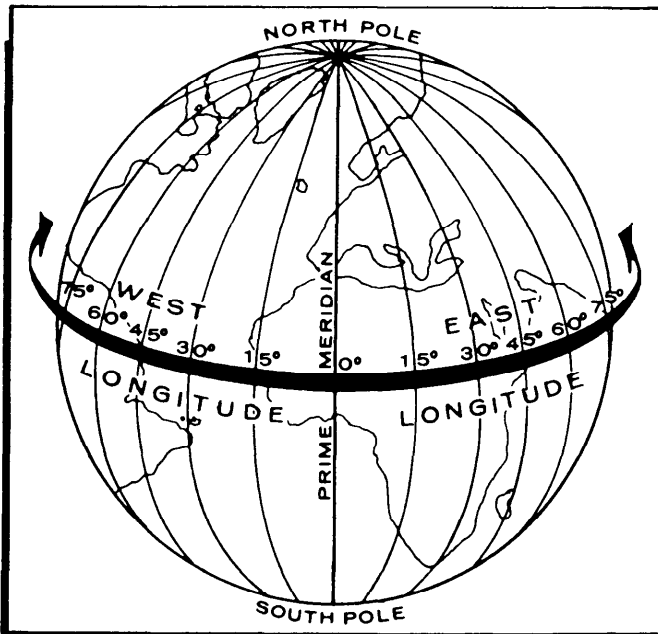

Figure 20-21. Meridian of Longitude.

west to the international dateline, meridians are assigned values of 0° through 180° west. The 0° meridian together with the 180° meridian forms a great circle which divides the Earth into east and west longitude (or hemispheres). There are 180° of east longitude plus 180° of west longitude for 360° of longitude.

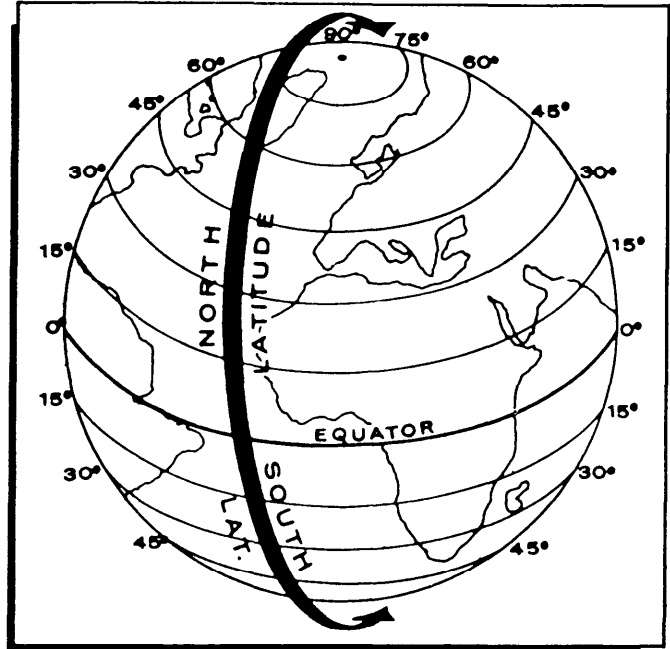

Figure 20-22. Parallels of Latitude.

b. Parallels of Latitude. Notice in figure 20-22 that the circles running in an east-west direction are of varying diameters (sizes). Only the circle designated "Equator" is a great circle. All others are small circles. Note that all circles are parallel to the Equator and run laterally around the Earth. Hence, each circle is called a parallel of latitude. Unlike meridians, which extend only halfway around the Earth, a parallel of latitude extends all the way around the Earth; for the record, the Equator is also a parallel of latitude. Since the Equator is the only great circle of latitude, it is a natural starting point for the 0° value of latitude. The North and South Poles are designated 90° north latitude and 90° south latitude, respectively. Parallels between the Equator and North Pole carry values between 0° and 90° north; parallels between the Equator and the South Pole are assigned values between 0° and 90° south.

(1) Figure 20-23 combines the lines of latitude and longitude. Lines 0° through 90° north or south latitude and 0° through 180° east or west longitude form the grid of the geographic coordinate system. Study the positions of Points A and B in figure 20-23. Determine the geographic coordinates of each in degrees. Note that point A is positioned 32° north of the Equator and 35° east of the prime meridian. The geographic position of point A, therefore, is 32° north 35° east. Point B is located 25° south of the Equator and 40° west of the prime meridian. Hence, the geographic position of point B is 25° south 40° west.

(2) Just as any point within the city of Gridville (figure 20-20) can be referenced by the intersection of

two imaginary lines, any point on the Earth's surface can be referenced by the intersection of the imaginary lines of latitude and longitude.

c. Writing Geographic Coordinates. To illustrate the proper way to write geographic coordinates, let's assume that a person needs to write the coordinates of a target. The target is located 30° 20' north of the Equator and 135° 06' east of the prime meridian. Thus, the position is located at 30° 20' north latitude and 135° 06' east longitude. By combining latitude and longitude, the position of the geographic location can be expressed as 30° 20' N 135° 06' E. To write these coordinates in the correct military form, eliminate the degree (°) and minute (') symbols. Thus, the coordinates would be written 302000N1350600E.

(1) Writing geographic coordinates in the military form is necessary for wire and radio transmission of geographic coordinates. Why? The transmission equipment does not include the degree (°), minute ('), and second (") characters in its keyboards. Coordinates are also stored in automated data processing computers which are programmed to handle coordinates in military characters or spaces. If the sequence of numbers and letters fed into a computer is less than 15 spaces, or in error, the resulting printout will be meaningless.

(2) When a position is located that is less than 10° latitude, a zero is added to the left of the degree number. For example, 7° of latitude is written as 07. Likewise, two digits always designate minutes and two digits for seconds. Thus, 7° N becomes 07N; 7° 6' N becomes 0706N; and 7° 6' 5" N becomes 070605N. In expressing longitude, three digits are required to indicate degrees, two digits for minutes, and two digits for seconds. Thus

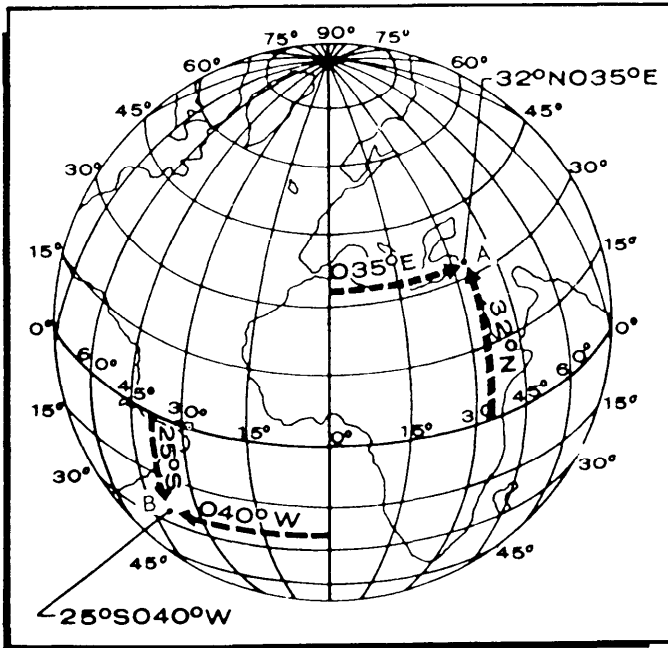

Figure 20-23. Latitudes and Longitudes.

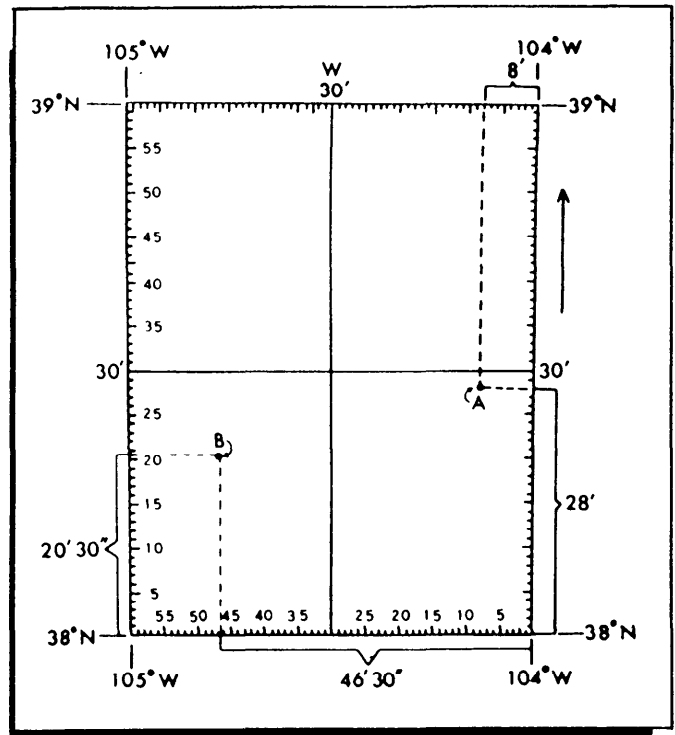

Figure 20-24. Plotting Geographic Coordinates.

8° E becomes 008E; 8° 5' E becomes 00805E; and 8° 5' 4" E becomes 0080504E.

(3) In general, there are five rules to follow in correctly writing geographic coordinates:

- (a) Write latitude first, followed by longitude.
- (b) Use an even number of digits for latitude and an odd number of digits for longitude.
- (c) Do not use a dash or leave a space between latitude and longitude.
- (d) Use single upper case letter to indicate direction from the Equator and prime meridians.
- (e) Omit the symbols for degrees, minutes, and seconds.

d. Plotting Geographic Coordinates:

(1) One can probably read the coordinates of point A and B in figure 20-24 rather easily; however, plotting points on maps from given coordinates must also be done. To do this, first get acquainted with the map being used. Assume that figure 20-24 is the map being used. Note that it covers an area from 38N to 39N and from 104W to 105W, an area of 1° by 1°. Also note that latitude and longitude are subdivided by 30' division lines and then with tick marks into 5- and 1-minute subdivisions.

(2) Assume that the coordinates of the point which must be plotted are 382800N1040800W. Next, follow the general procedure listed below to plot the point on the map:

- (a) Locate the parallel of latitude for degrees (38°N).

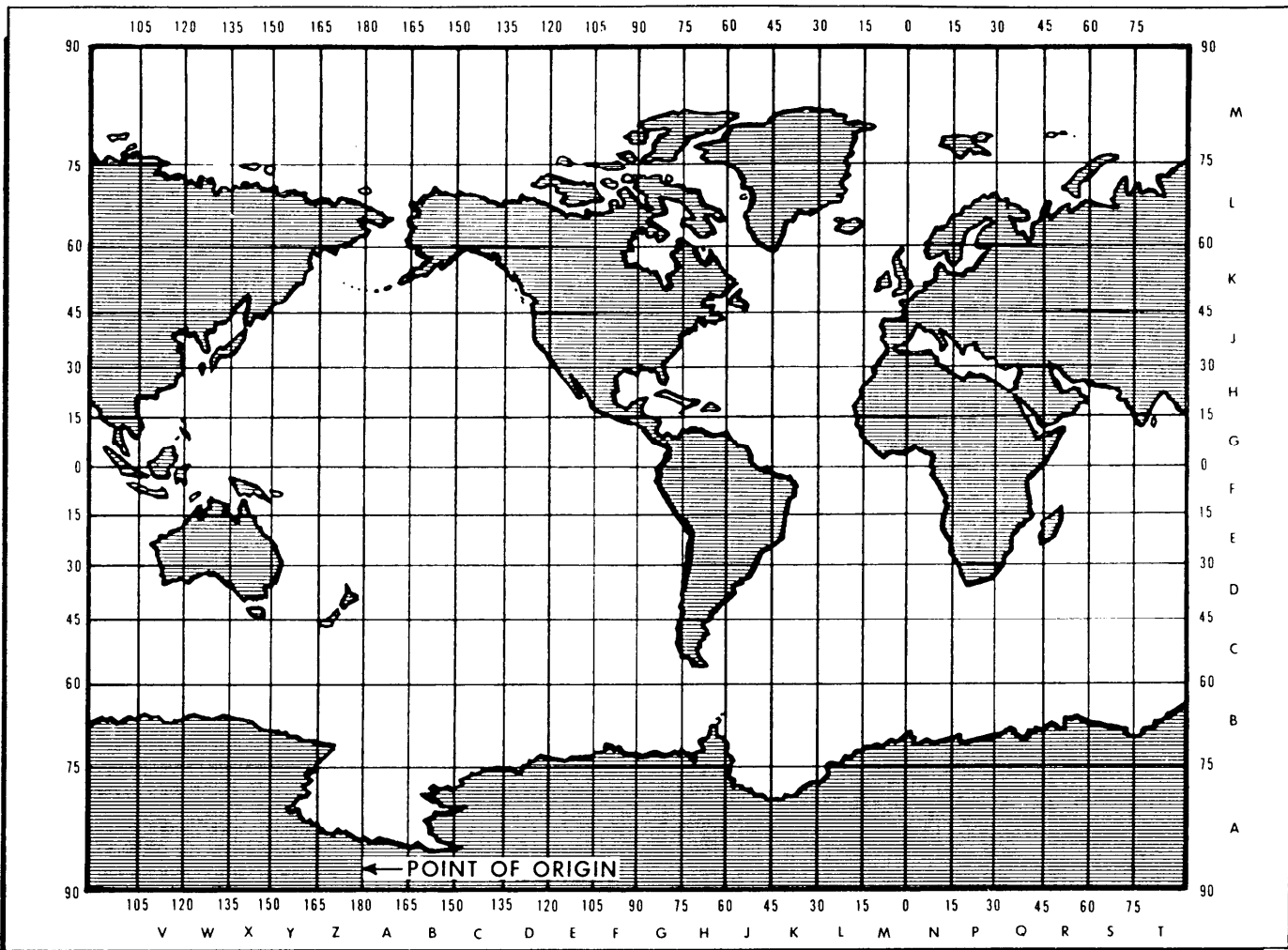

Figure 20-25. GEOREF 15-Degree Quadrants.

(b) Find the meridian of longitude for degrees (104°W).

(c) Move to the meridian (usually a tick mark) for minutes (08°W).

(d) Move to the parallel (usually a tick mark) for minutes (28°N).

(e) Plot the point on the map (point A in figure 20-24; plot at $382800\text{N}1040800\text{W}$).

(3) Recovery points, rally points, and destination positions may be plotted or identified on a map or chart to enable rescue personnel, the survivors, and evaders to locate these positions. Seconds are not shown between the 1-minute tick marks on maps and charts; they must be estimated. It is easy to estimate halfway tick marks (30 seconds); one-fourth (15 seconds) and three-fourths (45 seconds) are also reasonably easy to estimate. Then, as experience is gained, people will find that on large-scale maps they can estimate the sixths (10 seconds) and eighths (about 8 seconds). They cannot, however, accurately estimate to sixths or eighths at the scale shown in figure 20-24.

(4) To write geographic coordinates more precisely

than minutes, merely carry the coordinates out to include seconds. In the previous example, the coordinates of a target located $30^{\circ}20'$ north of the Equator and $135^{\circ}06'$ east of the prime meridian were written as $302000\text{N}1350600\text{E}$. A more exact position of the target might be $30^{\circ}20'05''\text{N}$ latitude and $135^{\circ}06'16''\text{E}$ longitude. This more precise position is correctly written as $302005\text{N}1350616\text{E}$.

e. World Geographic Reference System (GEOREF).

The geographic coordinate system has several shortcomings when it is used in military operations. One objectionable feature is the large number of characters necessary to identify a location. To specify a location within 300 yards, a coordinate reading such as $241412\text{NO}141512\text{W}$ is necessary, with a total of 15 characters. Another objectionable feature is the diversity of directions used in applying the grid numbering system. Any particular point on a geographic grid can be north and east, north and west, south and east, or south and west. This means there are four different ways to proceed when reading various geographic coordinates.

Such a system obviously promotes errors. To overcome the disadvantages and promote speed in position reporting, other grid systems are used. We shall now examine one of these systems—that which is commonly called GEOREF. Air Force uses the GEOREF system as a reference in the control and direction of forces engaged in large area operations and operations of a global nature.

(1) GEOREF System Structure. The geographic coordinate grid serves as the base for the GEOREF system. The grid originates at the 180° meridian and the South Pole. Starting at the 180° meridian, it proceeds right, or eastward, around the world, and back to the 180° starting point. From the South Pole, it proceeds northward to the North Pole (figure 20-25).

(a) Notice in figure 20-25 that the basic layout is subdivided into 24 east-west zones and 12 north-south zones. This forms 288 quadrangles that measure 15°X15°. The 24 east-west zones are lettered "A" through "Z" omitting "I" and "O." The 12 north-south zones are lettered "A" through "M" (omitting "I"). Each quadrangle is identified by two letters and is located by reading right and up. For example, the southern tip of Florida is located in GEOREF quadrangle G-H (figure 20-25).

(b) Each of the 15° quadrangles is divided into 1° quadrangles (figure 20-26). First, they are divided to the right into 15 zones lettered "A" through "Q" (omitting "I" and "O"), then up into 15 zones lettered "A" through "Q" ("I" and "O" omitted).

(c) This system makes it possible to identify any quadrangle by four letters; for example, WGAN. The two letters designate the 15° grid zone, and the other

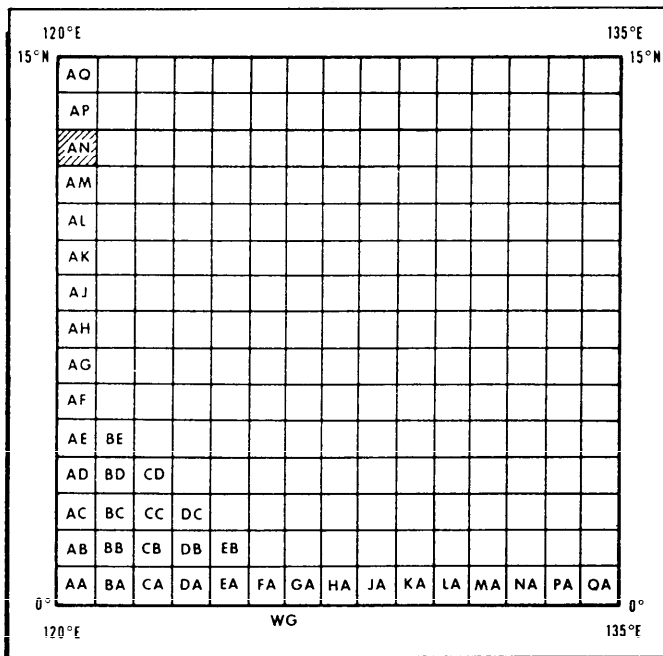

Figure 20-26. GEOREF 1-Degree Quadrants.

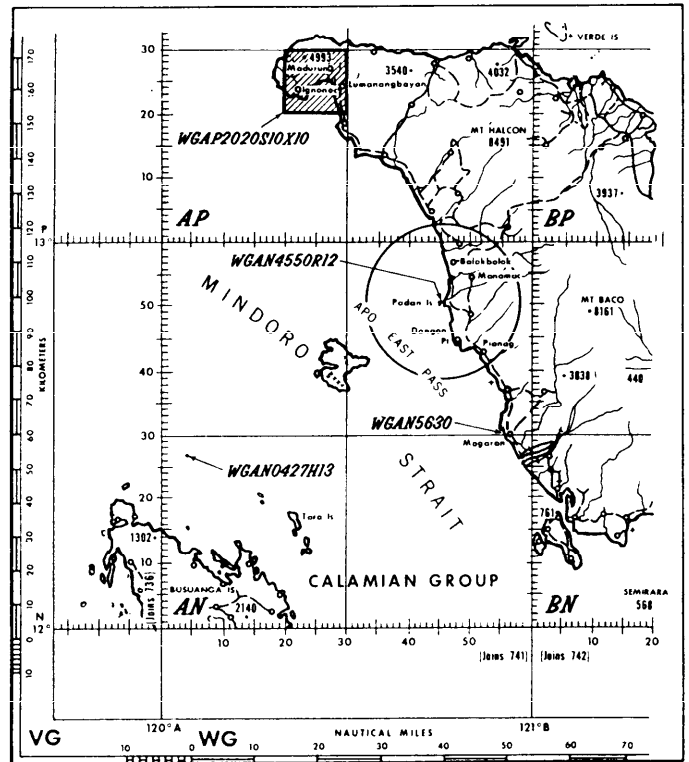

Figure 20-27. GEOREF 1-Degree Quadrants WGAN.

two letters identify a 1° quadrangle within the 15° grid zone. In figure 20-27, WGAN refers to the quadrangle situated between 120° east longitude and 12° and 13° north latitude. Notice that the 1° quadrangle WGAN is further divided by 30-minute division lines, and then with tick marks into 5- and 1-minute subdivisions.

(2) GEOREF Coordinates:

(a) Any feature within a 1° quadrangle can be located by reading the number of minutes to the right and the number of minutes up. For example, the city of Magaran (figure 20-27) can be located by proceeding as follows:

- 1. 15° X 15° quadrangle identification WG
- 2. 1° X 1° quadrangle identification WGAN
- 3. Minutes to the right WGAN 56
- 4. Minutes up WGAN 5630
- 5. Full GEOREF coordinate WGAN 5630

(b) If a reference of greater accuracy than 1 minute is required, the 1-minute tick marks may be divided into decimal values (tens or hundreds). By doing this, it is possible to locate a point within one-tenth of a minute with four letters and six numbers and within one-hundredth of a minute by four letters and eight numbers.

(3) GEOREF Special References. Another real advantage of the GEOREF system is the simplicity with

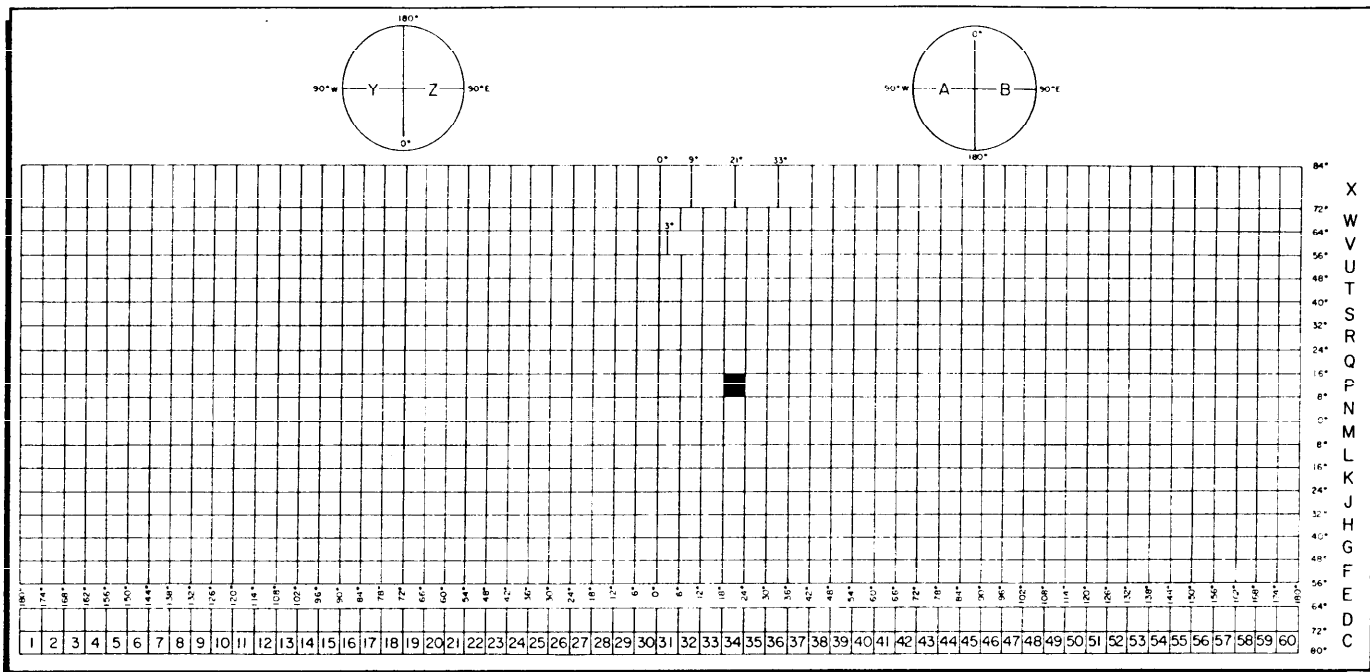

Figure 20-28. UPS Grid Zones.

which it allows a person to designate an area or indicate the elevation of a point. To designate the location and dimensions of a rectangular area, first read the GEOREF coordinates of the southwest corner of the area. Then add an "S," which denotes "side," and digits denoting the number of nautical miles that the area extends to the east. Then add an "X," denoting "by," and digits denoting the number of nautical miles the area extends to the north. An example of such a reference is WGAP2020S10X10 (figure 20-27). Circular areas are designated in much the same manner. First, read the GEOREF coordinates of the center of the area. Then add an "R," denoting radius, and digits defining the radius in nautical miles. This is also illustrated in figure 20-27 as WGAN4550R12.

(4) Military Grid Reference System. A grid is a rectangular coordinate system superimposed on a map. It consists of two sets of equally spaced parallel lines that are mutually perpendicular and form a pattern of squares. Some maps carry more than one grid. In such cases, each grid is shown in a different color or is otherwise distinguished. The military grid reference system is comprised of two grid systems. The US Army adopted the universal transverse mercator (UTM) grid for areas between 80° south latitude and 84° north latitude. For the polar caps, areas below 80° south latitude and above 84° north latitude, the universal polar stereographic (UPS) grid was adopted. The unit of measurement for the UTM and UPS grids are the meter, but the interval at which the grid lines are shown on the maps depends upon the scale.

(5) The UTM Grid System. In the UTM system, the surface of the Earth is divided into large quadrilater-

al grid zones (figure 20-28). Beginning at the 180th meridian, 6° columns are numbered 1 through 60 eastward with each column broken down into rows. From 80° south through 72° north, each row is 8° south-north.

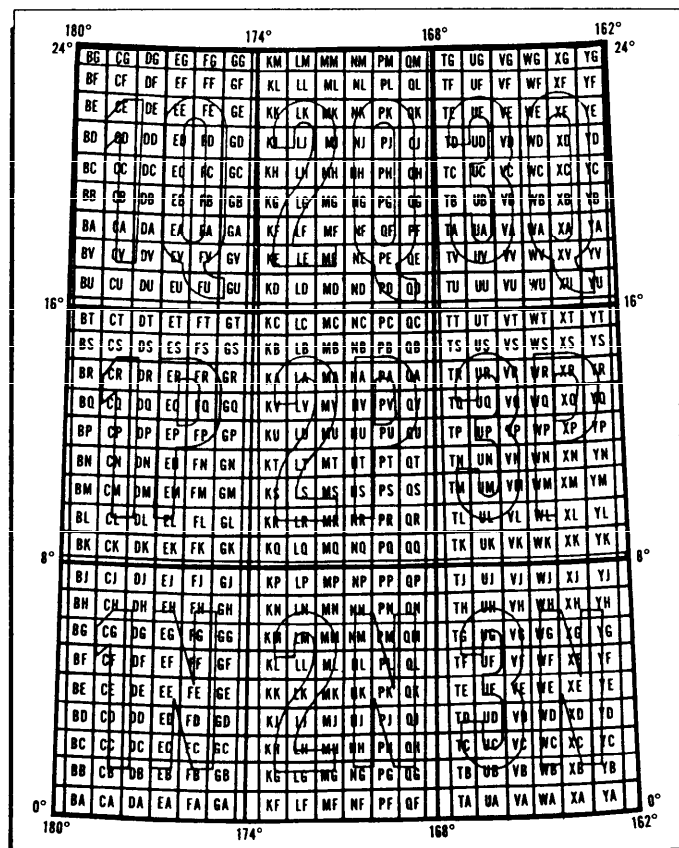

Figure 20-29. UTM Grid Zones.

The top row, 72° to 84° north is 12° south-north. The south-north rows are lettered "C" through "X" (omitting "I" and "O") as shown in figure 20-28. The grid zones are located by reading right and up. For instance, right to column 34 and up to "P" locates grid zone 34P, which is the shaded grid zone of figure 20-28. The UPS grid zones covering the polar areas are designated by a single "A," "B," "Y," or "Z" (figure 20-28).

(a) Each UTM grid zone is divided into columns and rows to form small squares measuring 100,000 meters on each side and are called 100,000-meter squares. Each square is identified with two letters. The columns are lettered "A" through "Z" (omitting "I" and "O"), starting at the 180th meridian and progressing eastward around. The 24 letters are repeated every 18° (figure 20-29). Starting at the Equator, the horizontal row 100,000-meter squares are lettered "A" through "V" (omitting "I" and "O") northward. From the Equator southward, the designation "V" through "A" is used. The letters are repeated periodically (figure 20-29).

(b) The Earth's meridians converge toward the poles. Therefore, the grid zones are not square or rectangular. The actual width of each grid zone decreases toward the poles. This condition causes partial squares

to occur along the grid zones. In the far north and south latitudes, the grid zones become so narrow that 100,000-meter square designations may disappear completely. However, each full or partial 100,000-meter square within a grid zone is referenced with two letters. The first letter refers to the vertical column (left to right), and the second letter identifies the horizontal row (bottom to top). Thus, a grid zone designation plus two letters identifies or designates an area 100,000 meters on each side. Furthermore, as the UTM system is set up, no two squares with the same designation are included in a grid zone or on the same map sheet.

(c) Observe grid zone 34P which is expanded in figure 20-30 to show the 100,000-meter squares. For grid zone 34P, the columns are designated "A" through "H," and the rows are designated "K" through "T" (omitting "O"). The left column begins with "A" because, as stated earlier, columns repeat the alphabet each 18°. The bottom row begins with "K" because "A" through "J" (omitting "I") was used up in the previous 8° of north latitude.

(d) Next, note the partial squares along the left and right sides of grid zone 34P (figure 20-30). Partial squares occur because the distance east and west of the central meridian of each grid zone does not contain an even number of 100,000-meter squares. The last squares, therefore, must terminate at the meridian junctions. In the north-south direction, partial 100,000-meter squares seldom occur.

(e) Figure 20-31 shows the grid reference box for a map or chart. Note the statement in the upper left corner of the grid reference box. It identifies the grid zones that are represented on the map sheet—52S and 53S. Thus, the full UTM coordinates of any point within the map area begins with either 52S or 53S.

(f) Still, it is not clear which area is 52S and which is 53S. Therefore, study the 100,000-meter square block identification located directly below the grid zone designation. From the diagram a person can see that everything to the left of the center meridian is grid zone 52S and everything to the right of the same meridian is 53S.

(g) Other important information given in the grid reference block includes: (1) sample reference and, (2) step-by-step procedures for locating or writing coordinates. Each time a new map is used, identify the sample point and write its UTM coordinates to ensure the grid breakdown for that map is understood.

(h) A troublesome and sometimes confusing situation exists where 100,000-meter squares fuse together along meridians separating grid zones. Remember, this happens every 6° around the world. Notice in figure 20-32 that the 100,000-meter squares GP and KJ are only partial squares, fusing along the center meridian (so are GQ, GN, KH, and KK). There are then full and

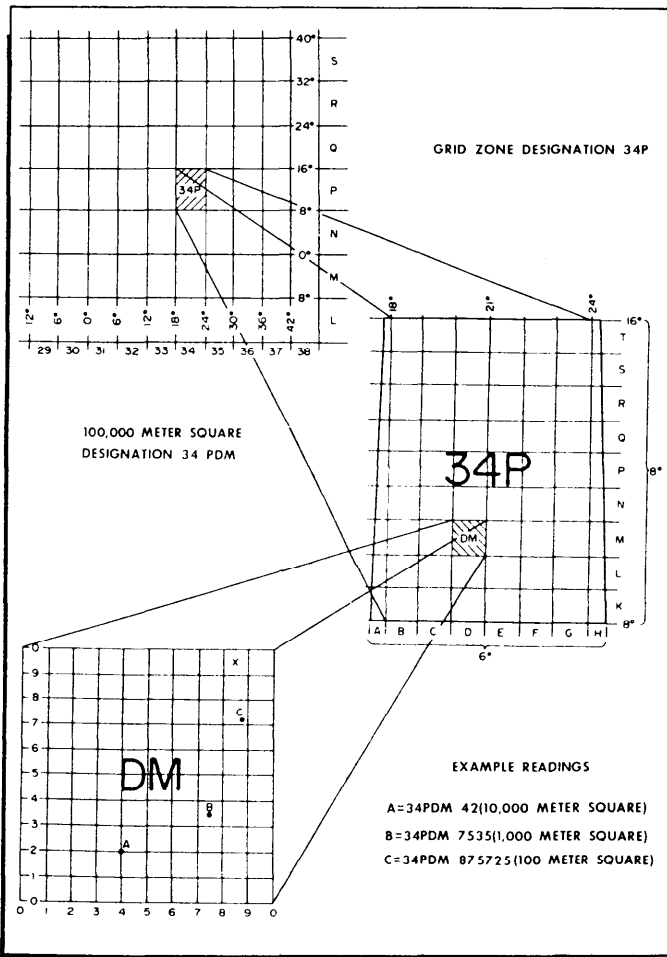

Figure 20-30. Plotting UTM Grid Coordinates.

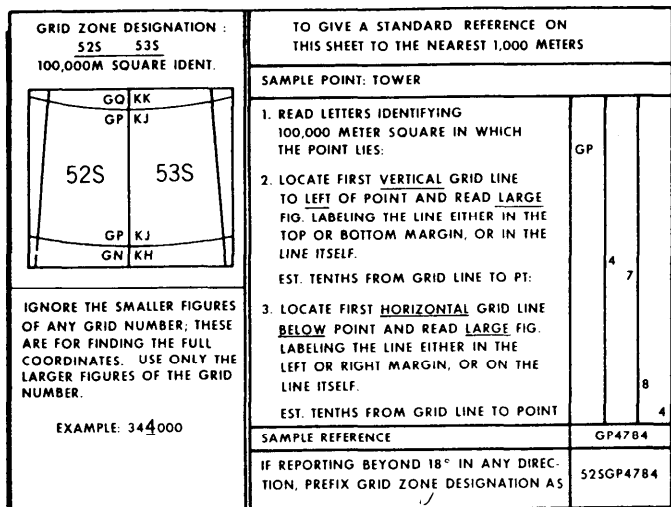

Figure 20-31. UTM Grid Reference Box.

partial 10,000 meter-squares within GP and KJ. Column 7 of the GP is comprised of partial 10,000-meter squares; columns 8 and 9 are missing because of the forced fusing along the meridian; similarly, column 2 of KJ is partial; columns O and I are missing. There is no problem in reading coordinates with full 10,000-meter squares. The tower in GP (sample point in figure 20-32) is 47 right and 84 up (omitting the grid zone and 100,000 meter square designation. All partial 100,000-meter squares are full sized in a north-south dimension). Therefore, distances up are referenced as full squares. However, partial squares, which occur in an east-west dimension, are something less than 10,000 meters long. Points within such partial squares are referenced as if the omitted part were present. That is, each partial square is imaginarily expanded into a full-sized square for reference purposes.

(i) The city of Bergen is 40 up; Celle is 35 up. Celle is three-tenths of the horizontal distance between grid line 7 and grid line 8—if there were a grid line 8. Thus, Celle is 73 right, and its full coordinates are 52SGP7335. Bergen is eight-tenths of the distance (reading left to right) between grid line 2—and grid line 3. Thus Bergen is 28 right, its full coordinates are 53SKJ2840.

(j) Figure 20-32 depicts a UTM grid breakdown as it normally appears on 1:250,000 scale charts. The smallest physical square is 10,000 meters on each side. However, larger scale maps with grid squares of 1,000 or even 100 meters on each side may be used. If so, add the values for the smaller grid squares. As additional digits are added, more precise points on the Earth's surface can be located.

(6) The UPS Grid System. The UPS reference system is the companion system to the UTM system. It covers the area of the world above 84° north latitude and below 80° south latitude. The UPS has a similar

divisional breakdown and is read or written like the UTM system.

(a) Figure 20-33 shows the arbitrarily assigned designations for the UPS system in the North and South Pole regions. Note that from the small circles of the figure, the polar area is divided into two grid zone divisions by the 180° and 0° meridians. The west longitude half is designated "grid zone A or Y." Also notice that no numbers are used with the letters to identify the grid zones.

(b) The two grid zones "A" and "B" of the South Pole are divided into 100,000-meter squares, as shown in the large circle of figure 20-33. Each square is identified by a two-letter designation, which is assigned so no duplication exists between the two grid zones. The letters "I" and "O" are omitted, and to avoid confusion with 100,000-meter squares in adjoining UTM zones, the letters D, E, M, N, V, and W are also omitted.

(c) The UPS system is also read right and then up. Thus, the shaded 100,000-meter square at 10 o'clock in figure 20-33 is identified as AQR. (Remember, no numbers are used in identifying the grid zone.) The shaded 100,000-meter square near the South Pole of the same drawing is identified as BBM.

(d) The UPS breakdown of the North Pole region is similar to the South Pole region. Conversion of figure 20-33 to fit the North Pole would require the following changes: Substitute grid zone letters "Y" for "A" and "Z" for "B," and interchange the 0° and 180° positions on the common parallel at 80° South latitude. Designation of the 100,000-meter squares for the North Pole region is shown in figure 20-33.

(e) If the map scale is sufficiently large, the 100,000-meter squares can be subdivided into smaller squares of 10,000 meters on each side. Then, the 10,000-meter squares can be divided into 1,000-or even 100-meter squares. However, there is rarely a requirement in the polar regions for such a large-scale chart.

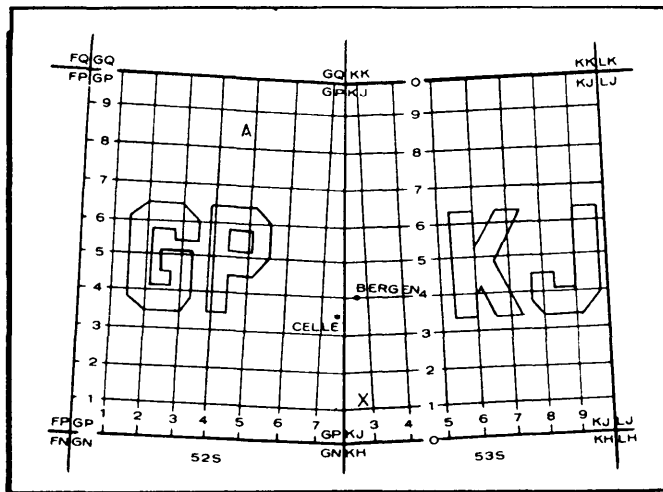

Figure 20-32. Fusion of Grid Zones 52S and 53S.

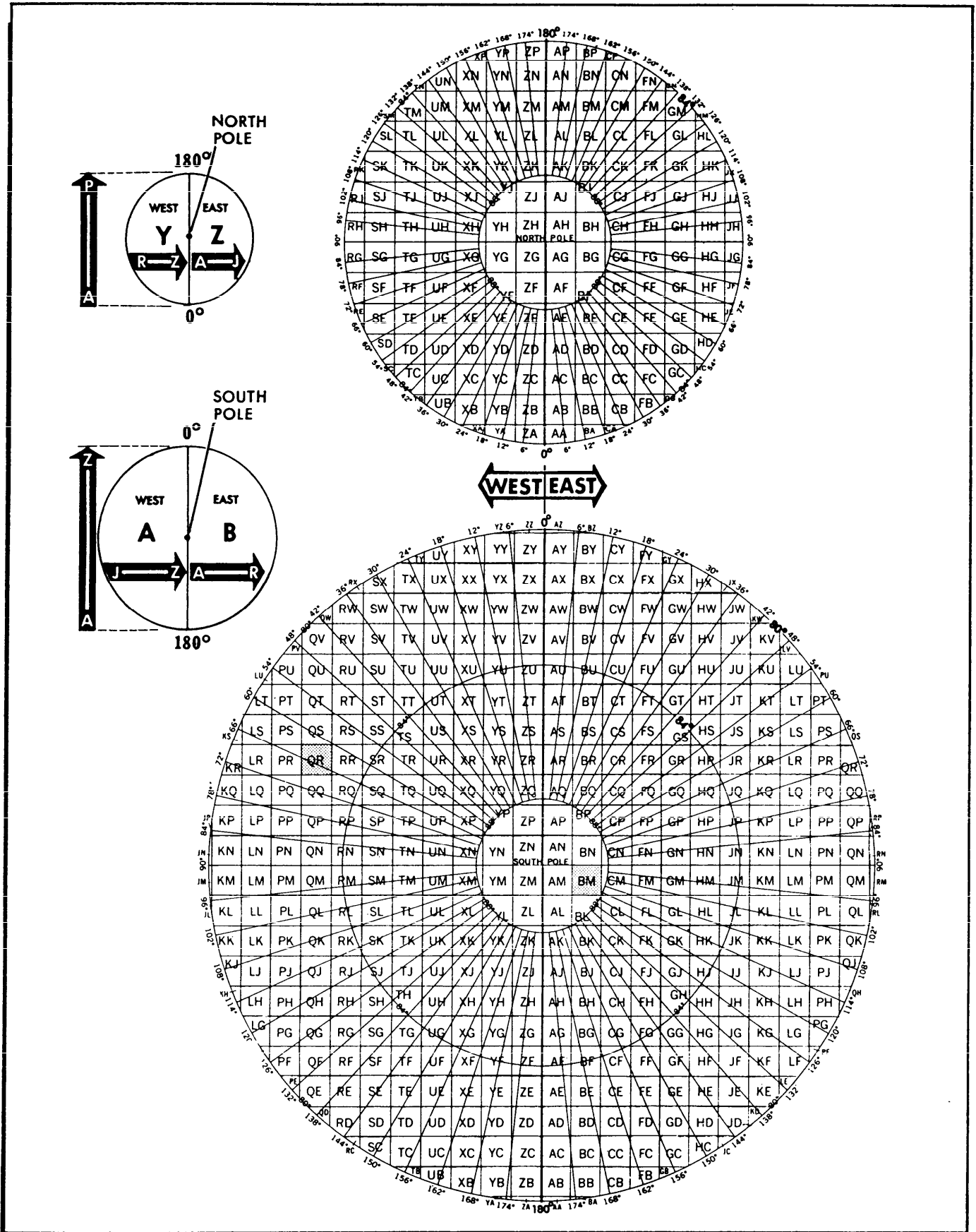

Figure 20-33. UPS Grid Zones.

Generally, a person can expect to work with small-scale charts with the grid broken down no further than 100,000-meter squares.

(7) Public Land Survey. In the western part of the United States or in areas which were not settled before the Federal Government was formed, all land is laid out in rectangular survey as established by the Government. This public land survey is based on all land being divided in relation to true north. Public land surveys all originate from six or seven initial points which are exact locations of even latitude and longitude lines which have been established astronomically.

(a) From any one of the initial points a true north-south line, referred to as the principal meridian, is established. From the same point a true east-west line, referred to as the baseline, is established. Along this principal meridian and baseline are laid out 6-mile squares or townships. Each of these townships are numbered in relation to the initial point of survey. To the east and west of the initial point, the townships are designated by range numbers; to the north and south of the initial point, the townships are designated by township numbers. Therefore, township 2 north, range 3 east, would lie between 6 and 12 miles north of the initial point and between 12 and 18 miles east of the initial point.

(b) Each township contains 36 square miles and is divided into 36 sections. A section is 1 square mile or 640 acres. The section layout on townships is the same throughout the Public Land Survey. The sections are numbered in rows back and forth beginning in the upper right-hand corner of the township and ending in the lower right-hand corner (figure 20-34).

(c) Each section is divided into quarters or quarter sections of 160 acres each. These quarter sections are named by the compass location in relation to the section. The upper right-hand quarter section is referred to as the northeast $\frac{1}{4}$, the lower right-hand quarter is the southeast $\frac{1}{4}$, the lower left-hand quarter is the southwest $\frac{1}{4}$, and the upper left-hand quarter is the northwest $\frac{1}{4}$.

(d) Each quarter section is further subdivided into quarters or four blocks of 40 acres each known as forties. The forties are also located by the compass directions. In locating a particular piece of property, the 40-compass quadrant is given first, followed by the quarter section quadrant. Thus the SW-SE means the southwest 40 of the southeast quarter section. This is the basic unit of land management and, therefore, one should become familiar with the Public Land Survey and the means of locating specific pieces of property.

between the two points? The map user must become proficient in recognizing various landforms and irregularities of the Earth's surface and be able to determine the elevation and differences in height of all terrain features.

a. Datum Plane. This is the reference used for vertical measurements. The datum plane for most maps is mean or average sea level.

b. Elevation. This is defined as the height (vertical distance) of an object above or below a datum plane.

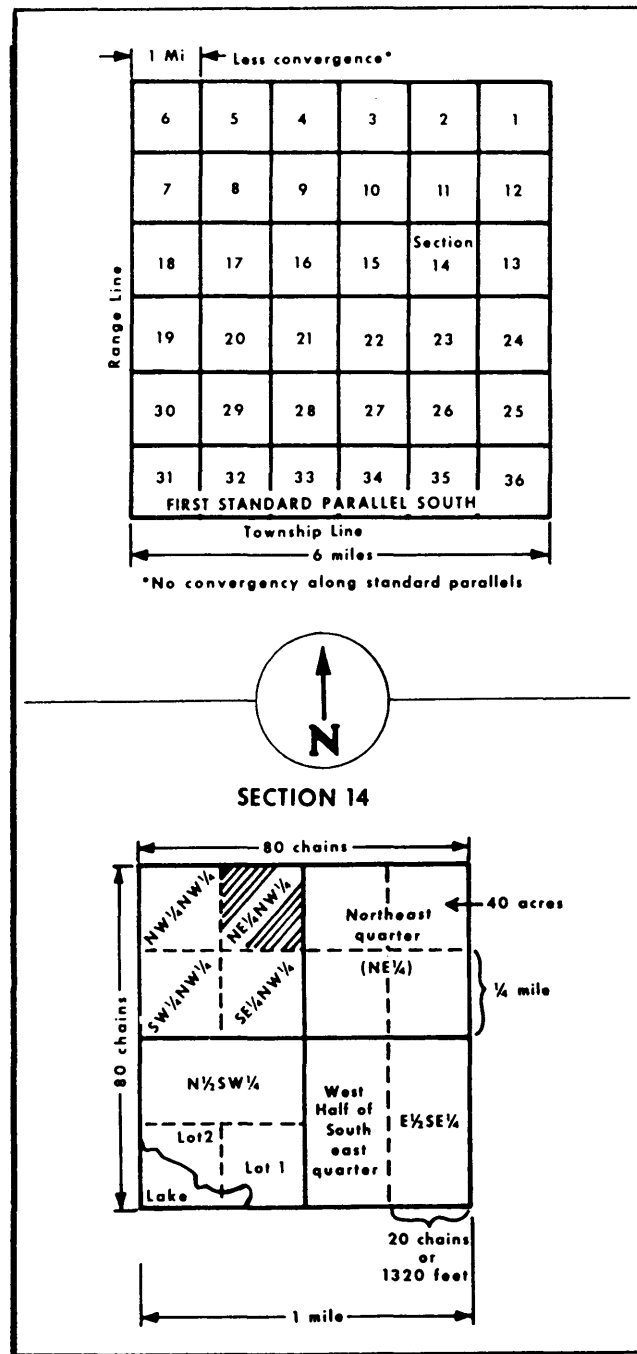

Figure 20-34. Section 14.

20-7. Elevation and Relief. A knowledge of map symbols, grids, scale, and distance gives enough information to identify two points, locate them, measure between them, and determine how long it would take to travel between them. But what happens if there is an obstacle

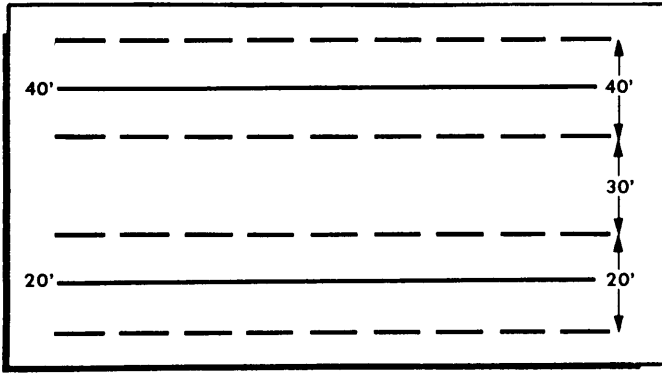

Figure 20-35. Estimating Elevation and Contour Lines

c. Relief. Relief is the representation of the shape and height of landforms and characteristic of the Earth's surface.

d. Contour Lines:

(1) There are several ways of indicating elevation and relief on maps. The most common way is by contour lines. A contour line is an imaginary line connecting points of equal elevation. Contour lines indicate a vertical distance above or below a datum plane. Starting at sea level, each contour line represents an elevation above sea level. The vertical distance between adjacent contour lines is known as the contour interval. The

amount of contour interval is given in the marginal information. On most maps, the contour lines are printed in brown. Starting at zero elevation, every fifth contour line is drawn with a heavier line. These are known as index contours and somewhere along each index contour, the line is broken and its elevation is given. The contour lines falling between index contours are called intermediate contours. They are drawn with a finer line than the index contours and usually do not have their elevations given.

(2) Using the contour lines on a map, the elevation of any point may be determined by:

(a) Finding the contour interval of the map from the marginal information, and noting the amount and unit of measure.

(b) Finding the numbered contour line (or other given elevation) nearest the point for which elevation is being sought.

(c) Determining the direction of slope from the numbered contour line to the desired point.

(d) Counting the number of contour lines that must be crossed to go from the numbered line to the desired point and noting the direction—up or down. The number of lines crossed multiplied by the contour interval is the distance above or below the starting value. If the desired point is on a contour line, its elevation is that of the contour; for a point between contours,

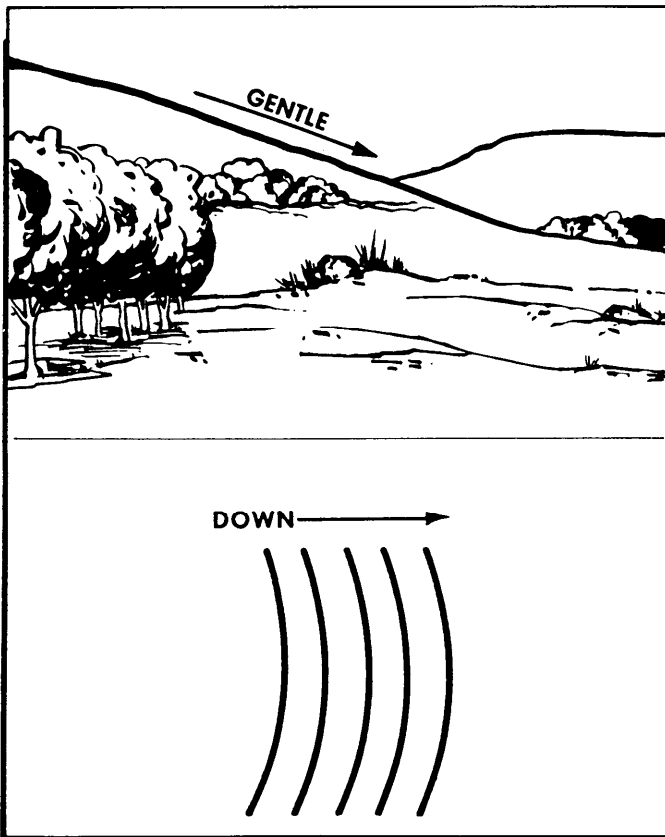

Figure 20-36. Uniform Gentle Slope.

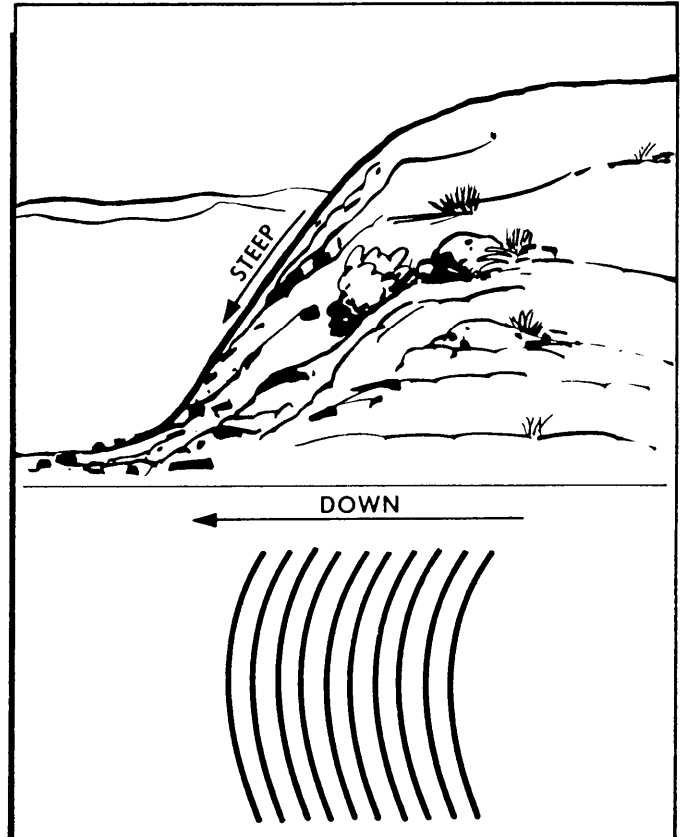

Figure 20-37. Uniform Steep Slope.

most military needs are satisfied by estimating the elevation to an accuracy of one-half the contour interval. All points less than one-fourth the distance between the lines are considered to be at the same elevation as the line. All points one-fourth to three-fourths the distance from the lower line are considered to be at an elevation one-half the contour interval above the lower line (figure 20-35).

(e) To estimate the elevation of the top of an unmarked hill, add half the contour interval to the elevation of the highest contour line around the hill. To estimate the elevation of the bottom of a depression, subtract half the contour interval from the value of the lowest contour around the depression.

(f) On maps where the index and intermediate contour lines do not show the elevation and relief in as much detail as may be needed, supplementary contour may be used. These contour lines are dashed brown lines, usually at one-half the contour interval for the map. A note in the marginal information indicates the interval used. They are used exactly as are the solid contour lines.

(g) On some maps contour lines may not meet the standards of accuracy but are sufficiently accurate in both value and interval to be shown as contour rather than as form lines. In such cases, the contours are considered as approximate and are shown with a dashed symbol; elevation values are given at intervals along the

heavier (index contour) dashed lines. The contour note in the map margin identifies them as approximate contours.

(h) In addition to the contour lines, bench marks and spot elevations are used to indicate points of known elevation on the map. Bench marks, the more accurate of the two, are symbolized by a black X, as X BM 124. The elevation value shown in black refers to the center of the X. Spot elevations shown in brown generally are located at road junctions, on hilltops, and other prominent landforms. The symbol designates an accurate horizontal control point. When a bench mark and a horizontal control point are located at the same point, the symbol BM is used.

(i) The spacing of the contour lines indicates the nature of the slope. Contour lines evenly spaced and wide apart indicate a uniform, gentle slope (figure 20-36). Contour lines evenly spaced and close together indicate a uniform, steep slope. The closer the contour lines to each other, the steeper the slope (figure 20-37). Contour lines closely spaced at the top and widely spaced at the bottom indicate a concave slope (figure 20-38). Contour lines widely spaced at the top and closely spaced at the bottom indicate a convex slope (figure 20-39).

(j) To show the relationship of land formations to each other and how they are symbolized on a contour map, stylized panoramic sketches of the major relief

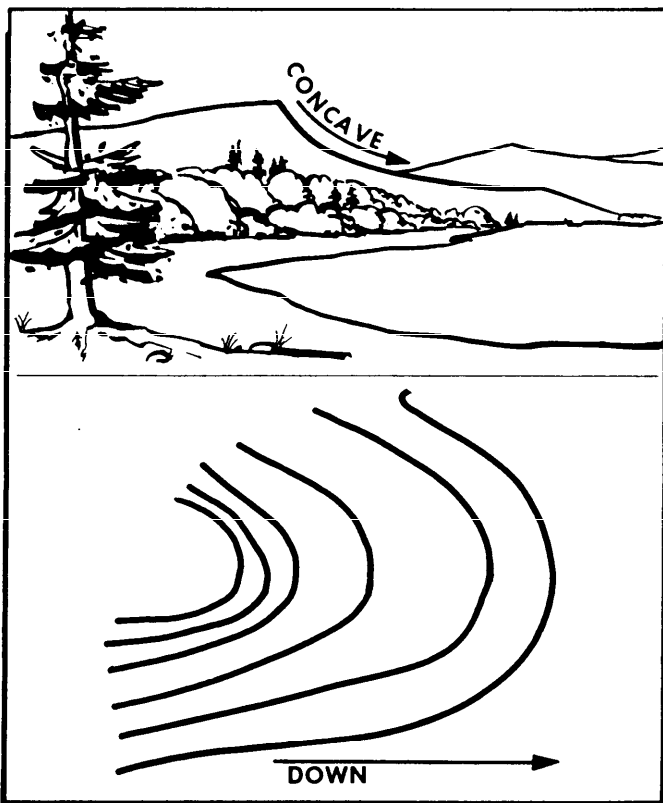

Figure 20-38. Concave Slope.

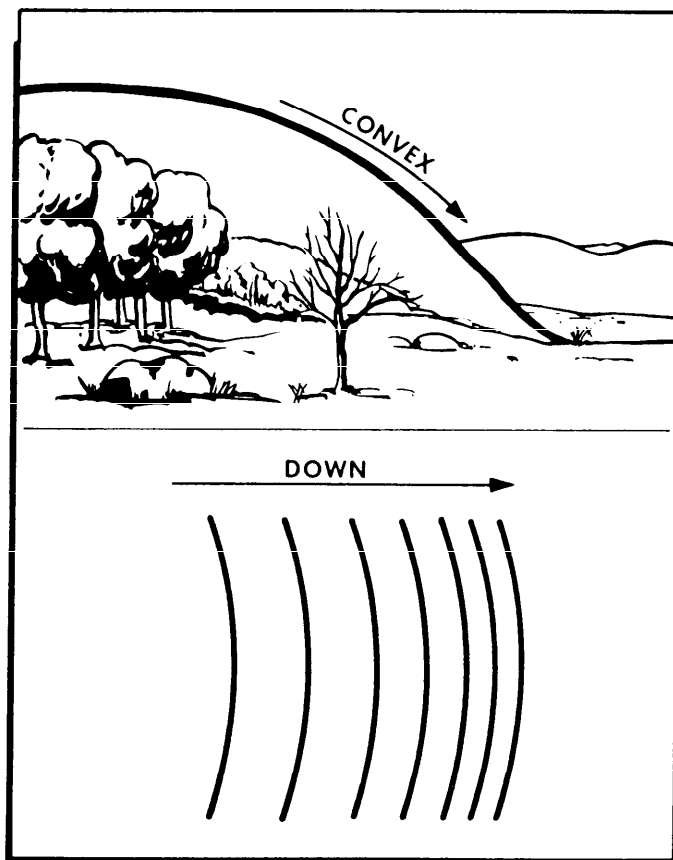

Figure 20-39. Convex Slope.

formations were drawn and a contour map of each sketch developed. Each figure (figure 20-40 through 20-46) shows a sketch and a map with a different relief feature and its characteristic contour pattern.

(3) Hill. A point or small area of high ground (figure 20-40). When one is located on a hilltop, the ground slopes down in all directions.

(4) Valley. Usually a stream course which has at least a limited extent of reasonably level ground bordered on the sides by higher ground (figure 20-41A). The valley generally has maneuvering room within its confines. Contours indicating a valley are U-shaped and tend to parallel a major stream before crossing it. The more gradual the fall of a stream, the farther each contour inner part. The curve of the contour crossing always points upstream.

(5) Drainage. A less-developed stream course in which there is essentially no level ground and, therefore, little or no maneuvering room within its confines (figure 20-41B). The ground slopes upward on each side and toward the head of the drainage. Drainages occur frequently along the sides of ridges, at right angles to the

valleys between the ridges. Contours indicating a drainage are V-shaped, with the point of the "V" toward the head of the drainage.

(6) Ridge. A range of hills or mountains with normally minor variations along its crest (figure 20-42A). The ridge is not simply a line of hills; all points of the ridge crest are appreciably higher than the ground on both sides of the ridge.

(7) Finger Ridge. A ridge or line of elevation projecting from or subordinate to the main body of a mountain or mountain range (figure 20-42B). A finger ridge is often formed by two roughly parallel streams cutting drainages down the side of a ridge.

(8) Saddle. A dip or low point along the crest of a ridge. A saddle is not necessarily the lower ground between two hilltops; it may simply be a dip or break along an otherwise level ridge crest (figure 20-43).

(9) Depression. A low point or sinkhole surrounded on all sides by higher ground (figure 20-44).

(10) Cuts and Fills. Manmade features by which the bed of a road or railroad is graded or leveled off by

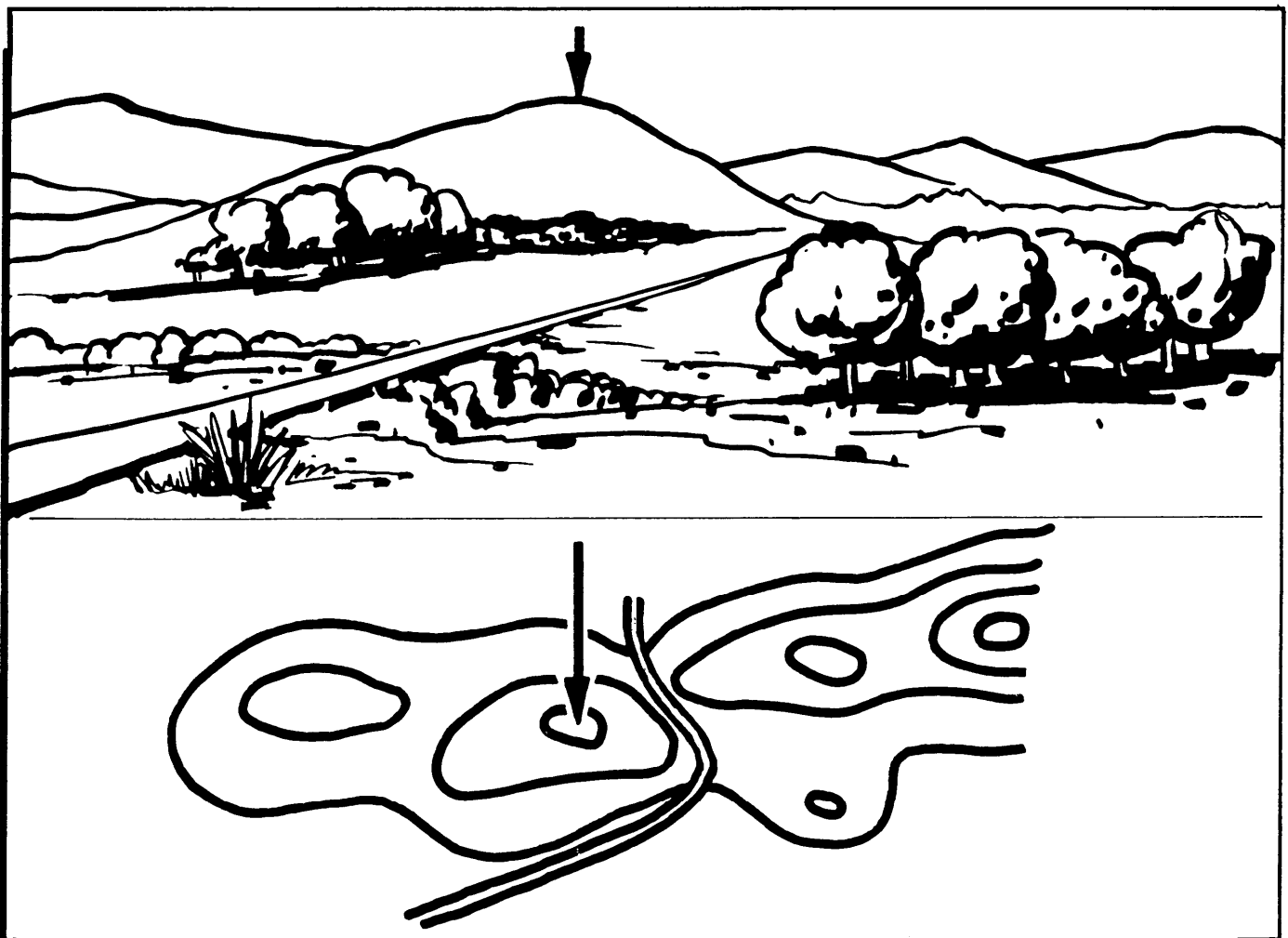

Figure 20-40. Hill.

cutting through high areas (figure 20-45A) and filling in low areas (figure 20-45B) along the right-of-way.

(11) Cliff. A vertical or near vertical slope (figure 20-46). When a slope is so steep that it cannot be shown at the contour interval without the contours fusing, it is shown by a ticked "carrying" contour(s). The ticks always point toward lower ground.

20-8. Representative Fraction (RF):

a. The numerical scale of a map expresses the ratio of horizontal distance on the map to the corresponding horizontal distance on the ground. It usually is written as a fraction, called the representative fraction (RF). The representative fraction is always written with the map distance as one (1). It is independent of any unit of measure. An RF of 1/50,000 or 1:50,000 means that one (1) unit of measure on the map is equal to 50,000 of the same units of measure on the ground.

b. The ground distance between two points is determined by measuring between the points on the map and multiplying the map measurement by the denominator of the RF.

Example: RF = 1:50,000 or $\frac{1}{50,000}$
 Map distance = 5 units (CM)
 $5 \times 50,000 = 250,000$ units (CM) of ground distance (figure 20-47).

c. When determining ground distance from a map, the scale of the map affects the accuracy. As the scale becomes smaller, the accuracy of measurement decreases because some of the features on the map must be exaggerated so that they may be readily identified.

20-9. Graphic (Bar) Scales:

a. On most military maps, there is another method of determining ground distance. It is by means of the graphic (bar) scales. A graphic scale is a ruler printed on the map on which distances on the map may be measured as actual ground distances. To the right of the zero (0), the scale is marked in full units of measure and is called the primary scale. The part to the left of zero (0) is divided into tenths of a unit and is called the extension scale. Most maps have three or more graphic scales, each of which measures distance in a different unit of measure (figure 20-48).

b. To determine a straight-line ground distance between two points on a map, lay a straight-edged piece of paper on the map so that the edge of the paper touches both points. Mark the edge of the paper at each point. Move the paper down to the graphic scale and read the ground distance between the points. Be sure to use the scale that measures in the unit of measure desired (figure 20-49).

c. To measure distance along a winding road, stream, or any other curved line, the straightedge of a piece of paper is used again. Mark one end of the paper and place it at the point from which the curved line is to be measured. Align the edge of the paper along a straight portion and mark both the map and the paper at the end of the aligned portion. Keeping both marks together, place the point of the pencil on the mark on the paper to hold it in place. Pivot the paper until another approximately straight portion is aligned and again mark on the map and the paper. Continue in this manner until measurement is complete. Then place the paper on the graphic scale and read the ground distance (figure 20-50).

d. Often, marginal notes give the road distance from the edge of the map to a town, highway, or junction of the map. If the road distance is desired from a point on the map to such a point off the map, measure the distance to the edge of the map and add the distance speci-

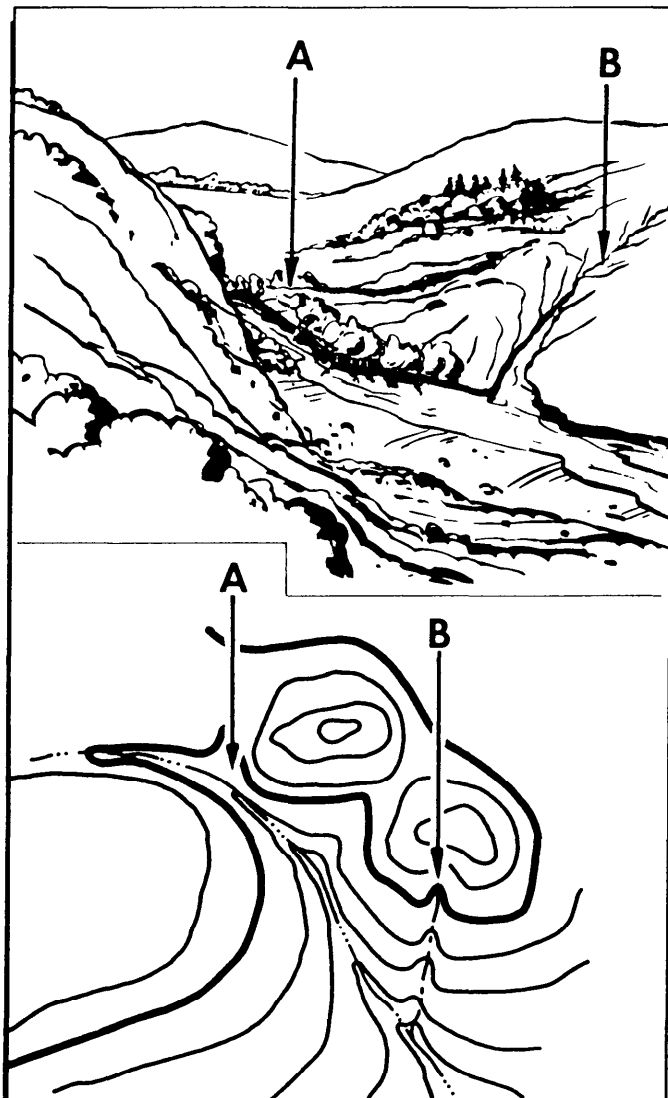

Figure 20-41. (A) Valley (B) Drainage.

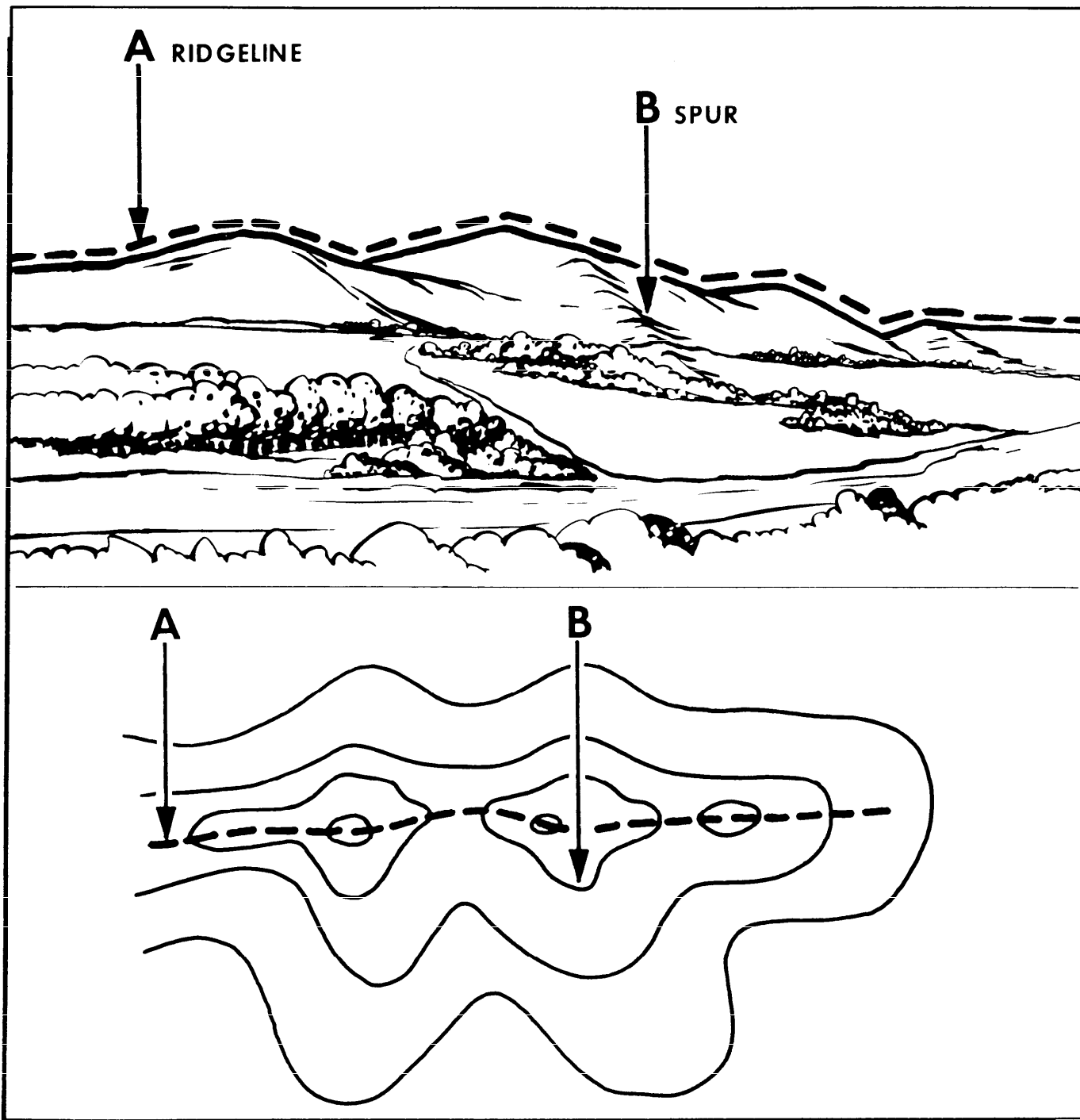

Figure 20-42. (a) Ridge Line (b) Finger Ridge.

fied in the marginal note to that measurement. Be sure the unit of measure is the same (figure 20-51).

20-10. Using a Map and Compass, and Expressing Direction:

a. To use a map, the map must correspond to the lay of the land, and the user must have a knowledge of direction and how the map relates to the cardinal directions. In essence, to use a map for land navigation, the

map must be “oriented” to the lay of the land. This is usually done with a compass. On most maps, either a declination diagram, compass rose, and lines of map magnetic variations are provided to inform the user of the difference between magnetic north and true north.

b. Directions are expressed in everyday life as right, left, straight ahead, etc.; but the question arises, “to the right of what?” Military personnel require a method of expressing direction which is accurate, adaptable for use

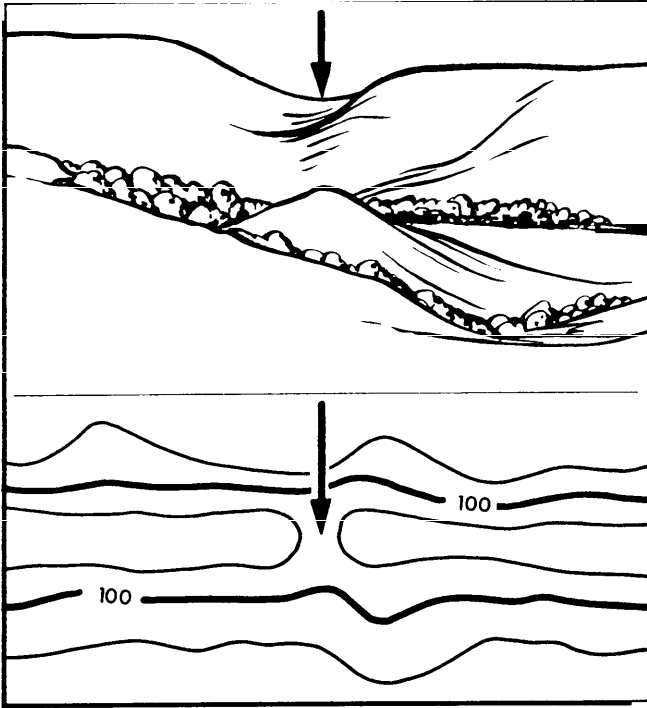

Figure 20-43. Saddle.

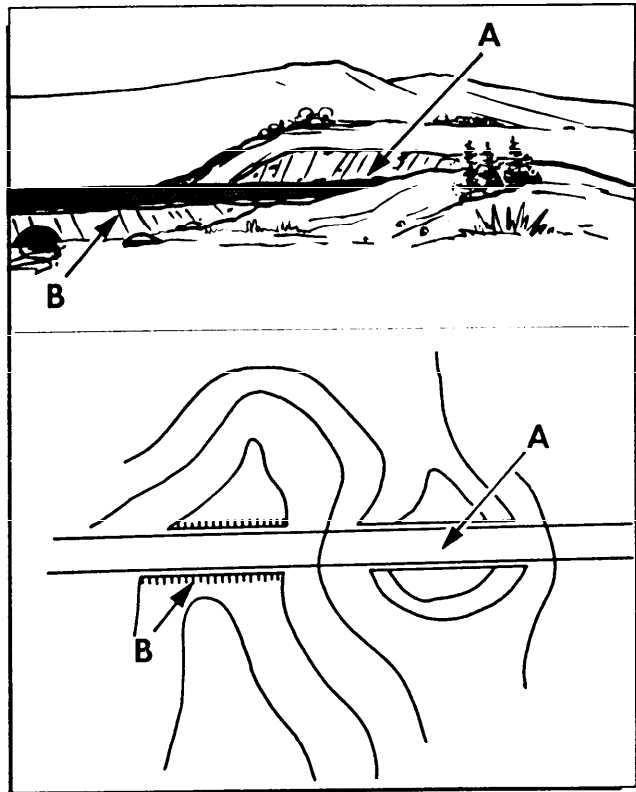

Figure 20-45. (A) Cut (B) Fill.

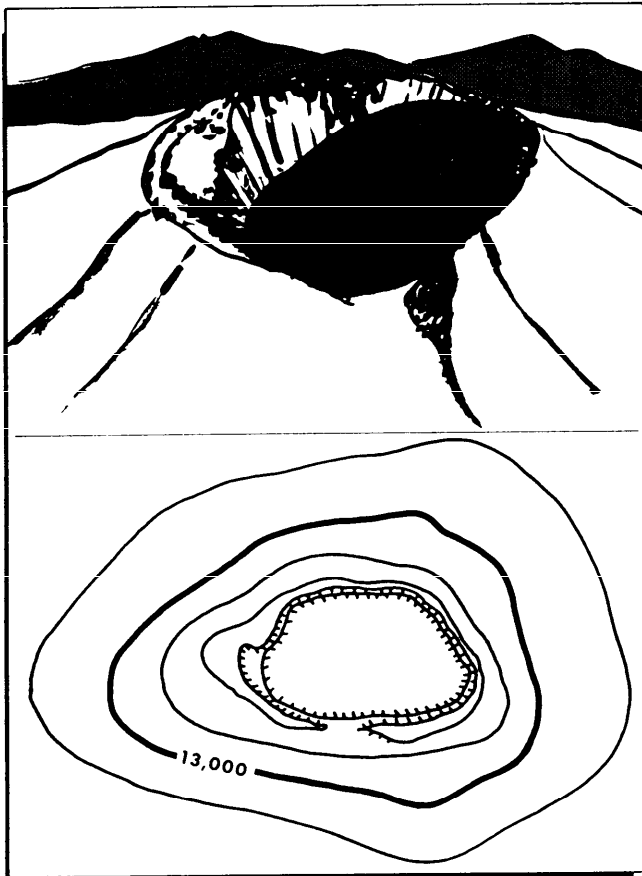

Figure 20-44. Depression.

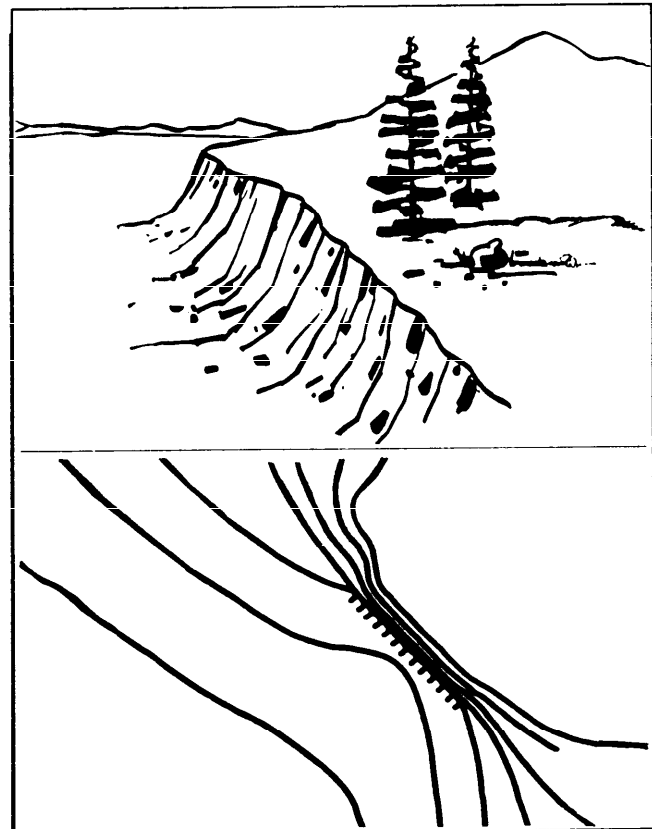

Figure 20-46. Cliff.

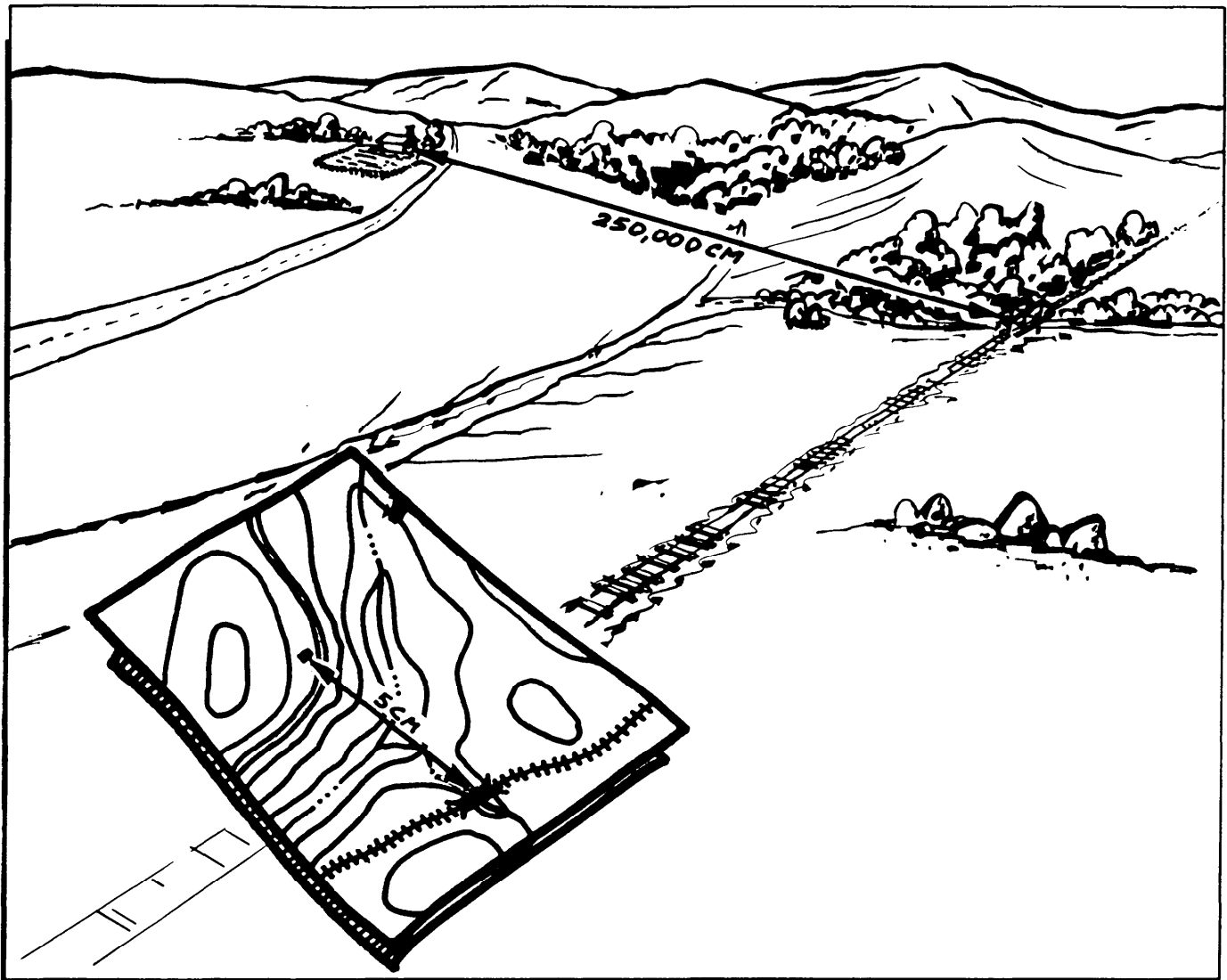

Figure 20-47. Ground Distance.

in any area of the world, and has a common unit of measure. Directions are expressed as units of angular measure. The most commonly used unit of angular measure is the degree with its subdivisions of minutes and seconds.

(1) Baselines. To measure anything, there must always be a starting point or zero measurement. To express a direction as a unit of angular measure, there must be a starting point or zero measurement and a point of reference. These two points designate the base or refer-

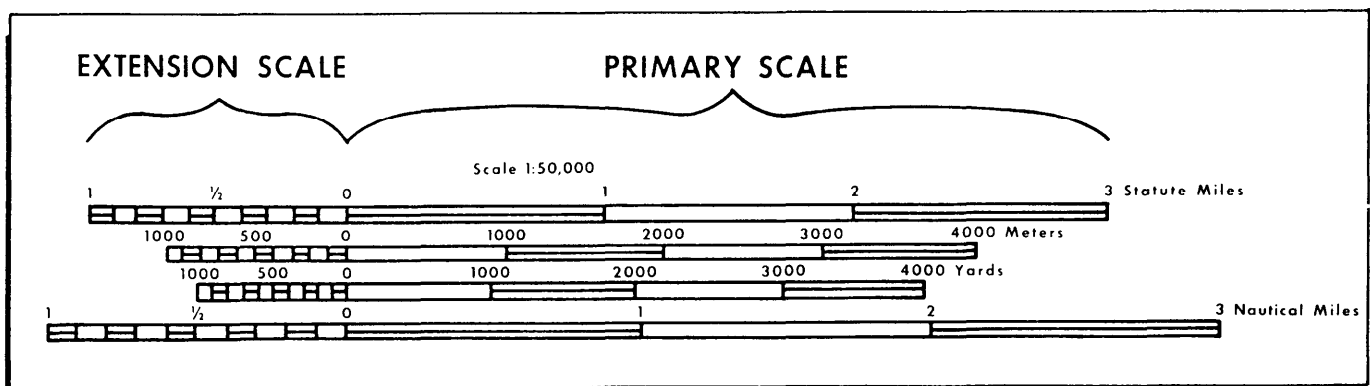

Figure 20-48. Graphic Bar Scale.

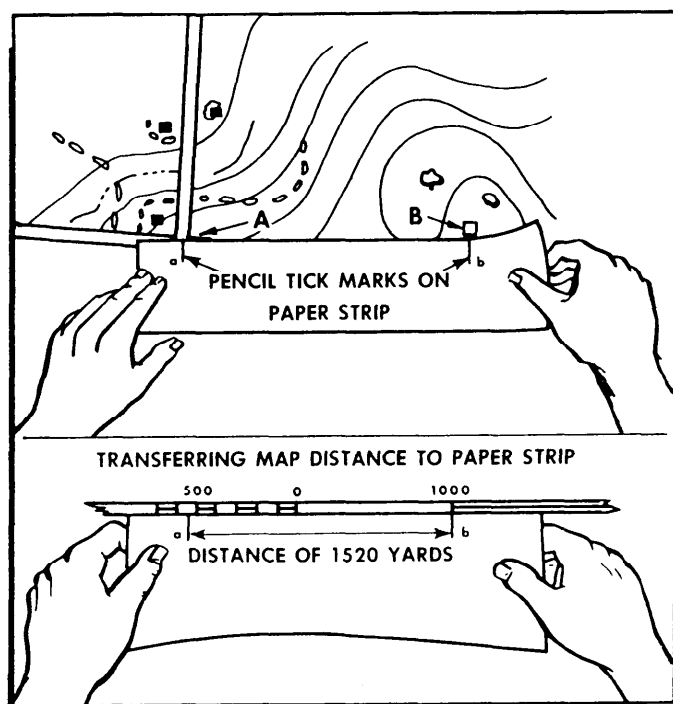

Figure 20-49. Measuring Straight Line Map Distances.

ence line. There are three baselines—true north, magnetic north, and grid north. Those most commonly used are magnetic and grid—the magnetic when working with a compass, and the grid when working with a military map.

(a) True north—a line from any position on the Earth's surface to the North Pole. All lines of longitude are true north lines. True north is usually symbolized by a star (figure 20-52).

(b) Magnetic north—the direction to the north magnetic pole, as indicated by the north-seeking needle of a magnetic instrument. Magnetic north is usually symbolized by a half arrowhead (figure 20-52).

(c) Grid north—the north established by the vertical grid lines on the map. Grid north may be symbolized by the letters GN or the letter Y.

(2) Azimuth and Back Azimuth:

(a) The most common method used by the military for expressing a direction is azimuths. An azimuth is defined as a horizontal angle, measured in a clockwise manner from a north baseline. When the azimuth between two points on a map is desired, the points are joined by a straight line and a protractor is used to measure the angle between north and the drawn line. This measured angle is the azimuth of the drawn line (figure 20-53). When using an azimuth, the point from which the azimuth originates is imagined to be the center of the azimuth circle (figure 20-54). Azimuths take their name from the baseline from which they are measured; true azimuths from true north, magnetic azimuths from magnetic north, and grid azimuths from

grid north (figure 20-52). Therefore, any given direction can be expressed in three different ways: a grid azimuth if measured on a military map, a magnetic azimuth if measured by a compass, or a true azimuth if measured from a meridian of longitude.

(b) A back azimuth is the reverse direction of an azimuth. It is comparable to doing an "about face." To obtain a back azimuth from an azimuth, add 180° if the azimuth is 180° or less, or subtract 180° if the azimuth is 180° or more (figure 20-55). The back azimuth of 180° may be stated as either 000° or 360° .

(3) Declination Diagram. A declination diagram is placed on most large-scale maps to enable the user to properly orient the map. The diagram shows the interrelationship of magnetic north, grid north, and true north (figure 20-56). On medium-scale maps, declination information is shown by a note in the map margin.

(a) Declination is the angular difference between true north and magnetic or grid north. There are two declinations, a magnetic declination (figure 20-57) and a grid declination.

(b) Grid-Magnetic (G-M) Angle is an arc indicated by a dashed line, which connects the grid north and the magnetic north prongs. The value of this arc (G-M ANGLE) states the size of the angle between grid north and magnetic north and the year it was prepared. This value is expressed to the nearest $\frac{1}{2}^\circ$, with mil equivalents shown to the nearest 10 mils.

(c) Grid Convergence is an arc, indicated by a dashed line, which connects the prongs for true north and grid north. The value of the angle for the center of the sheet is given to the nearest full minute with its equivalent to the nearest mil. These data are shown in the form of a grid convergence note.

(d) Conversion notes may also appear with the diagram explaining the use of the G-M angle. One note

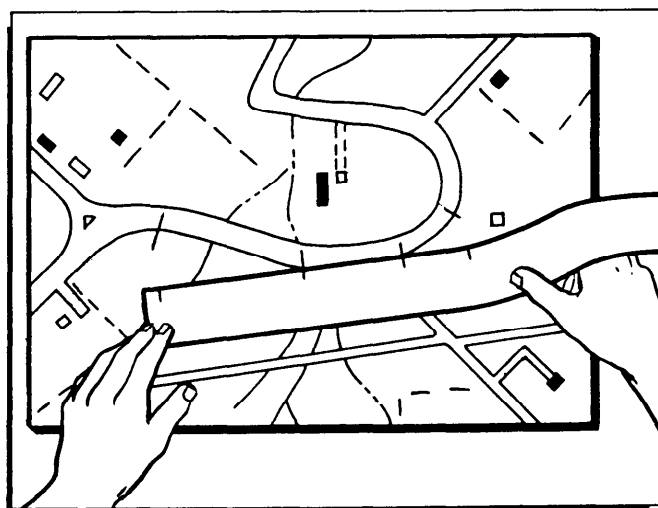

Figure 20-50. Measuring Curved Line Distances.

B-5. Conversion Factors							
One	Inches	Feet	Yards	Statute miles	Nautical miles	Millimeters	
Inch	1	0.0833	0.0277			25.40	
Foot	12	1	0.333			304.8	
Yard	36	3	1	0.00056		914.4	
Statute Mile	63,360	5,280	1,760	1	0.8684		
Nautical Mile	72,963	6,080	2,026	1.1516	1		
Millimeter	0.0394	0.0033	0.0011			1	
Centimeter	0.3937	0.0328	0.0109			10	
Decimeter	3.937	0.328	0.1093			100	
Meter	39.37	3.2808	1.0936	0.0006	0.0005	1,000	
Decameter	393.7	32.81	10.94	0.0062	0.0054	10,000	
Hectometer	3,937	328.1	109.4	0.0621	0.0539	100,000	
Kilometer	39,370	3,281	1,094	0.6214	0.5396	1,000,000	
Myriameter	393,700	32,808	10,936	6.2137	5.3959	10,000,000	

One	cm	dm	m	dkm	hm	km	mym
Inch	2.540	0.2540	0.0254	0.0025	0.0003		
Foot	30.48	3.048	0.3048	0.0305	0.0030	0.0003	
Yard	91.44	9.144	0.9144	0.0914	0.0091	0.0009	
Statute Mile	160,930	16,093	1,609	160.9	16.09	1.6093	0.1609
Nautical Mile	185,325	18,532	1,853	185.3	18.53	1.8532	0.1853
Millimeter	0.1	0.01	0.001	0.0001			
Centimeter	1	0.1	0.01	0.001	0.0001		
Decimeter	10	1	0.1	0.01	0.001	0.0001	
Meter	100	10	1	0.1	0.01	0.001	0.0001
Decameter	1,000	100	10	1	0.1	0.01	0.001
Hectometer	10,000	1,000	100	10	1	0.1	0.01
Kilometer	100,000	10,000	1,000	100	10	1	0.1
Myriameter	1,000,000	100,000	10,000	1,000	100	10	1

<p><i>Example I</i> Problem: Reduce 76 centimeters to (?) inches $76 \text{ cm} \times 0.3937 = 29 \text{ inches.}$ Answer: There are 29 inches in 76 centimeters.</p>	<p><i>Example II</i> Problem: How many feet are there in 2.74 meters? $\frac{2.74}{.3048} = 9 \text{ feet}$ Answer: There are approximately 9 feet in 2.74 meters.</p>
--	--

Figure 20-51. Conversion Factors.

provides instructions for converting magnetic azimuth to grid azimuth; the other note provides for converting grid azimuth to magnetic azimuth. The conversion (add or subtract) is governed by the direction of the magnetic north prong relative to the grid north prong.

(e) The grid north prong is aligned with the easting grid lines on the map, and on most maps is formed by an extension of an easting grid line into the margin.

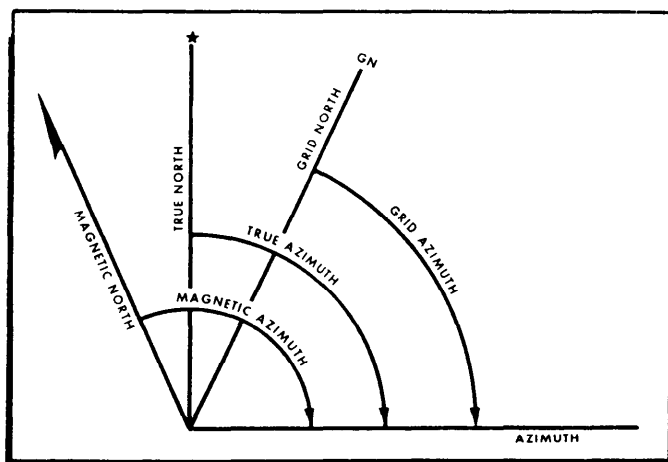

Figure 20-52. True, Grid and Magnetic Azimuths.

The angles between the prongs are seldom plotted exactly. The relative position of the directions is obtained from the diagram, but the numerical value should not be measured from it. For example, if the amount of declination from grid north to magnetic north is 1°, the arc shown in the diagram may be exaggerated if mea-

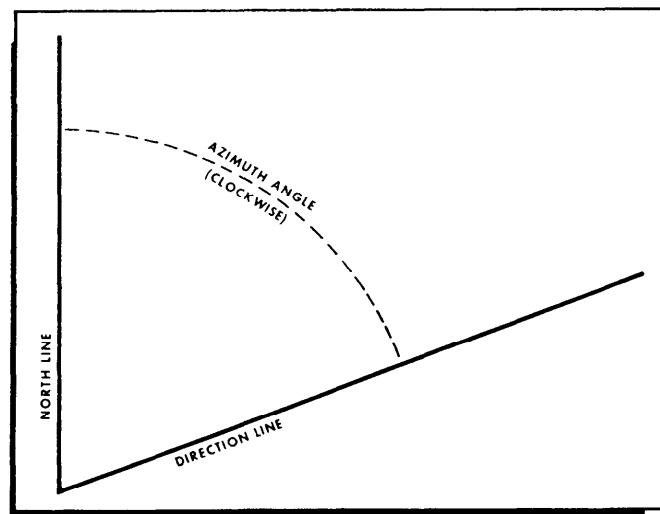

Figure 20-53. Azimuth Angle.

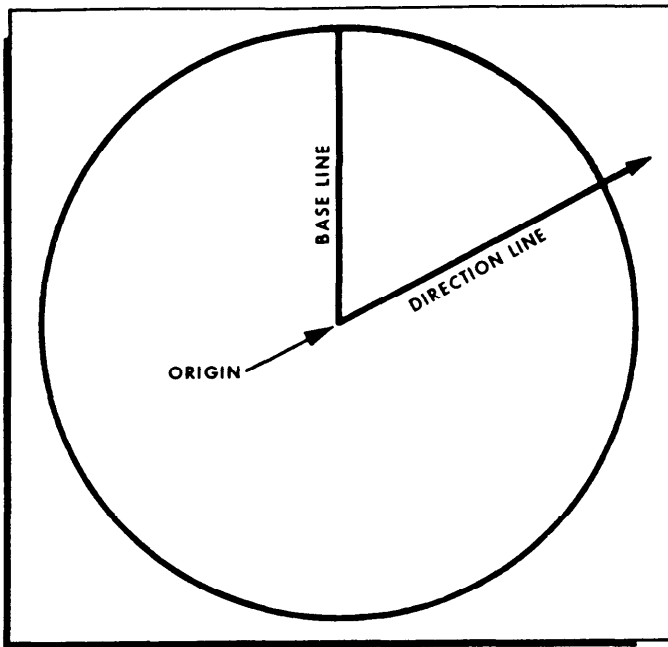

Figure 20-54. Origin of Azimuth Circle.

sured, having an actual value of 5° . The position of the three prongs in relation to each other varies according to the declination data for each map.

(f) Some older maps have a note under the declination diagram which gives the magnetic declination for a certain year and the amount of annual change. The annual change is so small when compared to the $\frac{1}{2}^\circ$ value of the G-M angle that it is no longer shown on standard large scale maps.

(4) Protractors. Protractors come in several forms—full circle, half circle, square, and rectangular (figure 20-58). All of them divide a circle into units of angular measure, and regardless of their shape, consist of a scale around the outer edge and an index mark. The index mark is the center of the protractor circle from which all the direction lines radiate.

(a) To determine the grid azimuth of a line from one point to another on the map from (A to B or C to D) (figure 20-59), draw a line connecting the two points.

-1. Place the index of the protractor at that point where the line crosses a vertical (north-south) grid line.

-2. Keeping the index at this point, align the 0° - 180° line of the protractor on the vertical grid line.

-3. Read the value of the angle from the scale; this is the grid azimuth to the point.

(b) To plot a direction line from a known point on a map (figure 20-60):

-1. Construct a north-south grid line through the known point:

-a. Generally, align the 0° - 180° line of the protractor in a north-south direction through the known point.

-b. Holding the 0° - 180° line of the protractor on the known point, slide the protractor in the north-south direction until the horizontal line of the protractor (connecting the protractor index and the 90° tick mark) is aligned on an east-west grid line.

-c. Then draw a line connecting 0° , the known point, and 180° .

-2. Holding the 0° - 180° line on the north-south line, slide the protractor index to the known point.

-3. Make a mark on the map at the required angle. (In an evasion situation, do not mark on the map.)

-4. Draw a line from the known point through the mark made on the map. This is the grid direction line.

(5) The Compass and Its Uses:

(a) The magnetic compass is the most commonly used and simplest instrument for measuring directions and angles in the field. The lensatic compass (figure 20-61) is the standard magnetic compass for military use today.

(b) The lensatic compass must always be held level and firm when sighting on an object and reading an azimuth (figure 20-62). There are several techniques for holding the compass and sighting. One way is to align the sighting slot with the hairline on the front sight

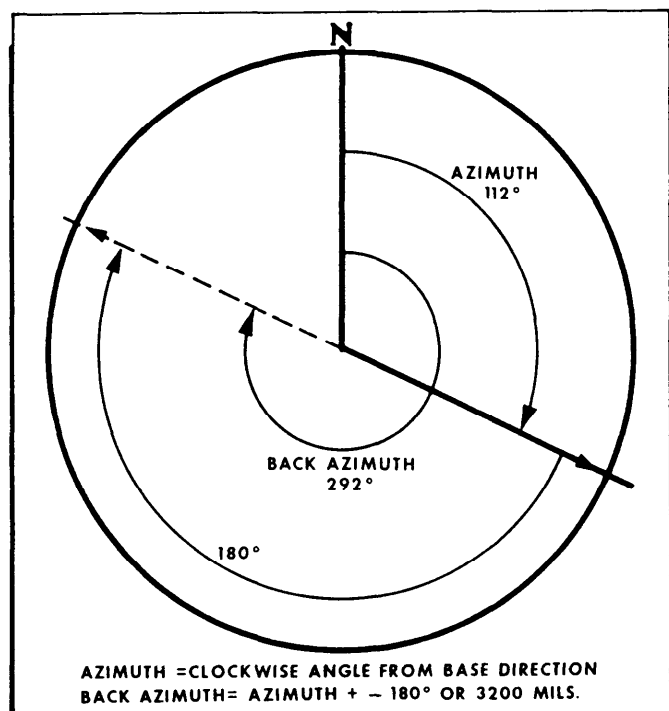

Figure 20-55. Azimuth and Back Azimuth.

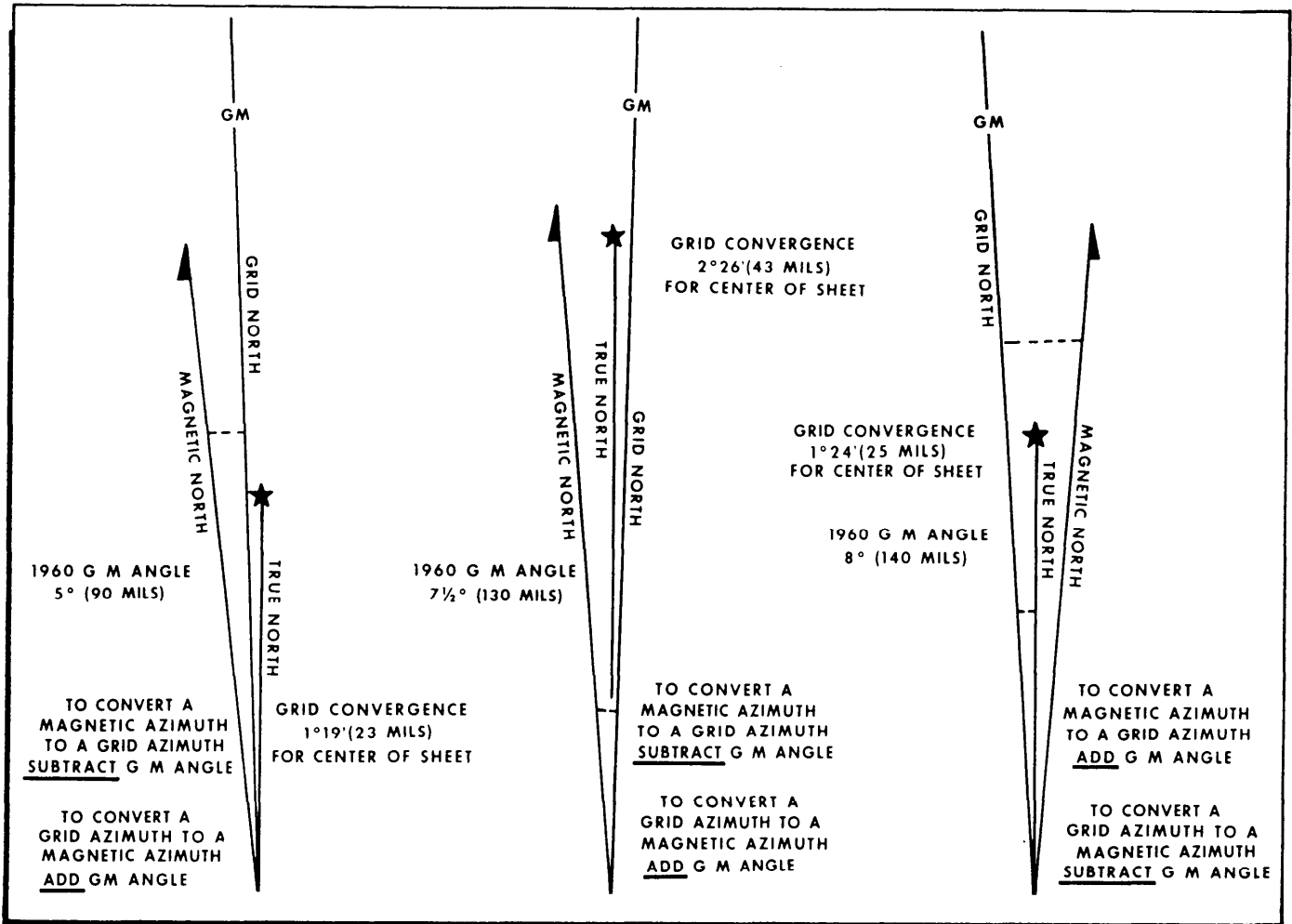

Figure 20-56. Declination Diagram (East and West).

in the cover and the target. The azimuth can then be read by glancing down at the dial through the lens. This technique provides a reading precise enough to use.

(6) Night Use of the Compass. For night use, special features of the compass include the luminous markings, the bezel ring, and two luminous sighting dots. Turning the bezel ring counterclockwise causes an increase in azimuth, while turning it clockwise causes a decrease. The bezel ring has a stop and spring which allows turns at 3° intervals per click and holds it at any desired position. One accepted method for determining compass directions at night is:

(a) Rotate the bezel ring until the luminous line is over the black index line.

(b) Hold the compass with one hand and rotate the bezel ring in a counterclockwise direction with the other hand to the number of clicks required. The number of clicks is determined by dividing the value of the required azimuth by 3. For example, for an azimuth of 51° , the bezel ring would be rotated 17 clicks counterclockwise (figure 20-63).

(c) Turn the compass until the north arrow is directly under the luminous line on the bezel.

(d) Hold the compass open and level in the palm of the left hand with the thumb along the side of the compass. In this manner, the compass can be held consistently in the same position. Position the compass approximately halfway between the chin and the belt, pointing to the direct front. (Practice in daylight will make a person proficient in pointing the compass the same way every time.) Looking directly down into the compass, turn the body until the north arrow is under the luminous line. Then proceed forward in the direction of the luminous sighting dots (figure 20-61). When the compass is to be used in darkness, an initial azimuth should be set while light is still available. With this initial azimuth as a base, any other azimuth which is a multiple of 3° can be established through use of the clicking feature of the bezel ring. The magnetic compass is a delicate instrument, especially the dial balance. The survivor should take care in its use. Compass readings should never be taken near visible masses of iron or electrical circuits.

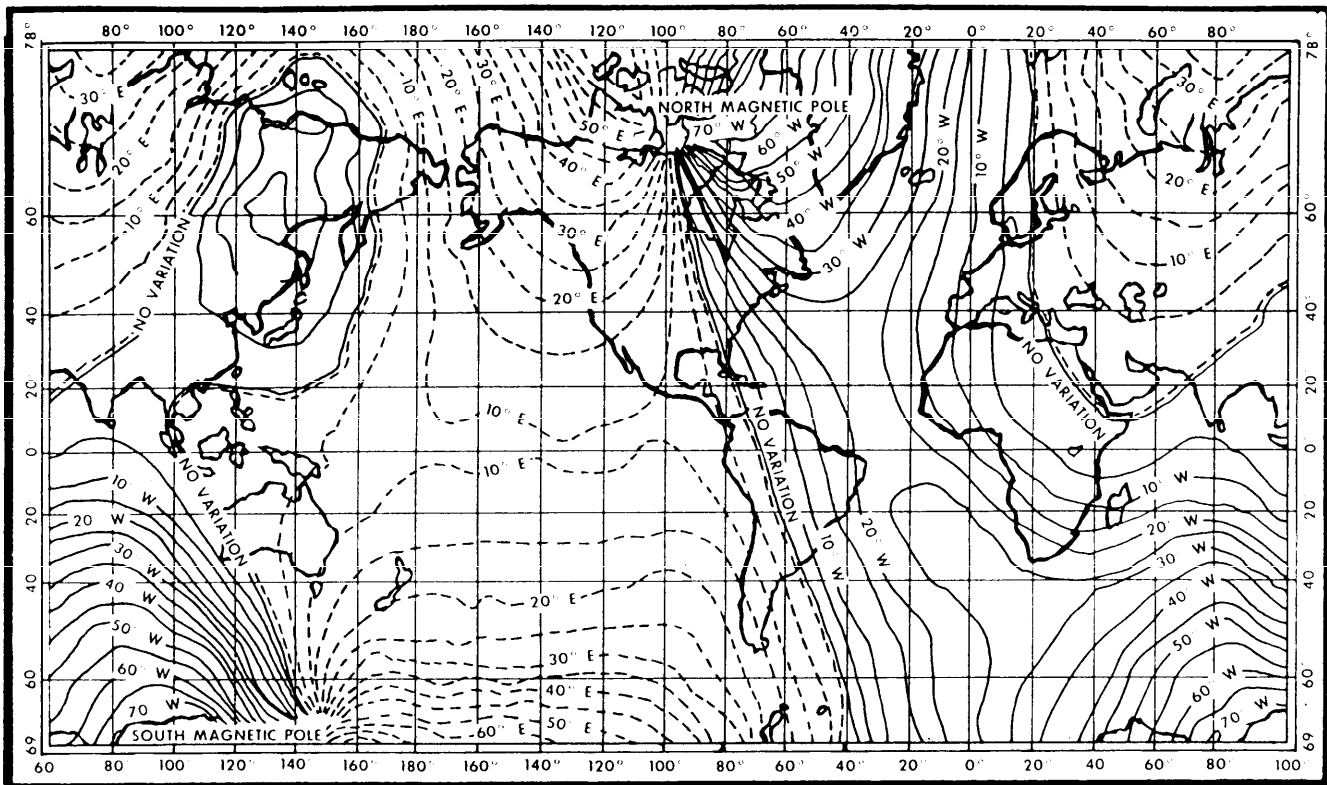

Figure 20-57. Lines of Magnetic Variation.

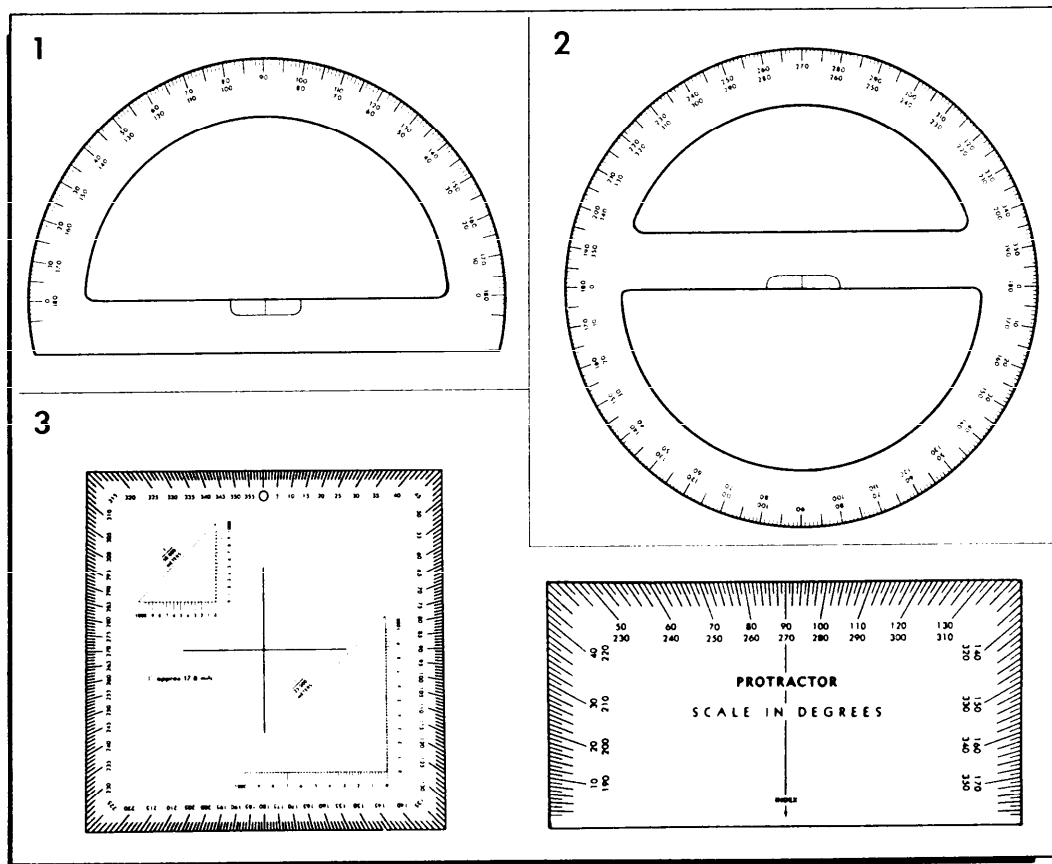

Figure 20-58. Types of Protractors.

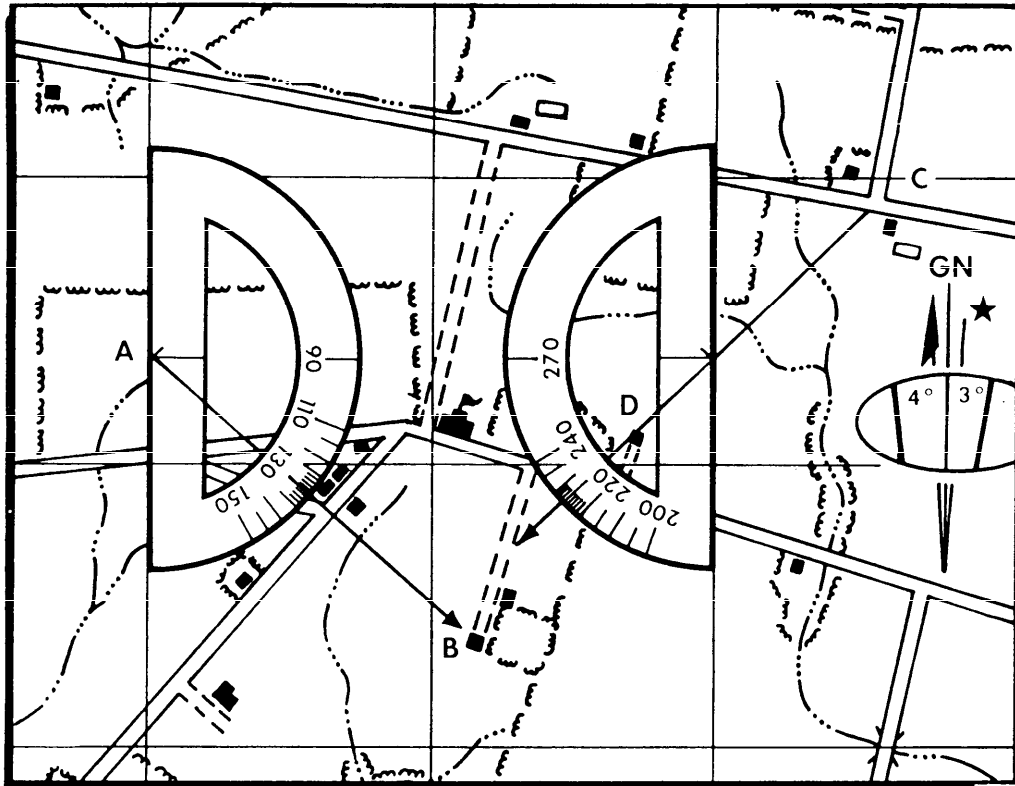

Figure 20-59. Measuring an Azimuth on a Map.

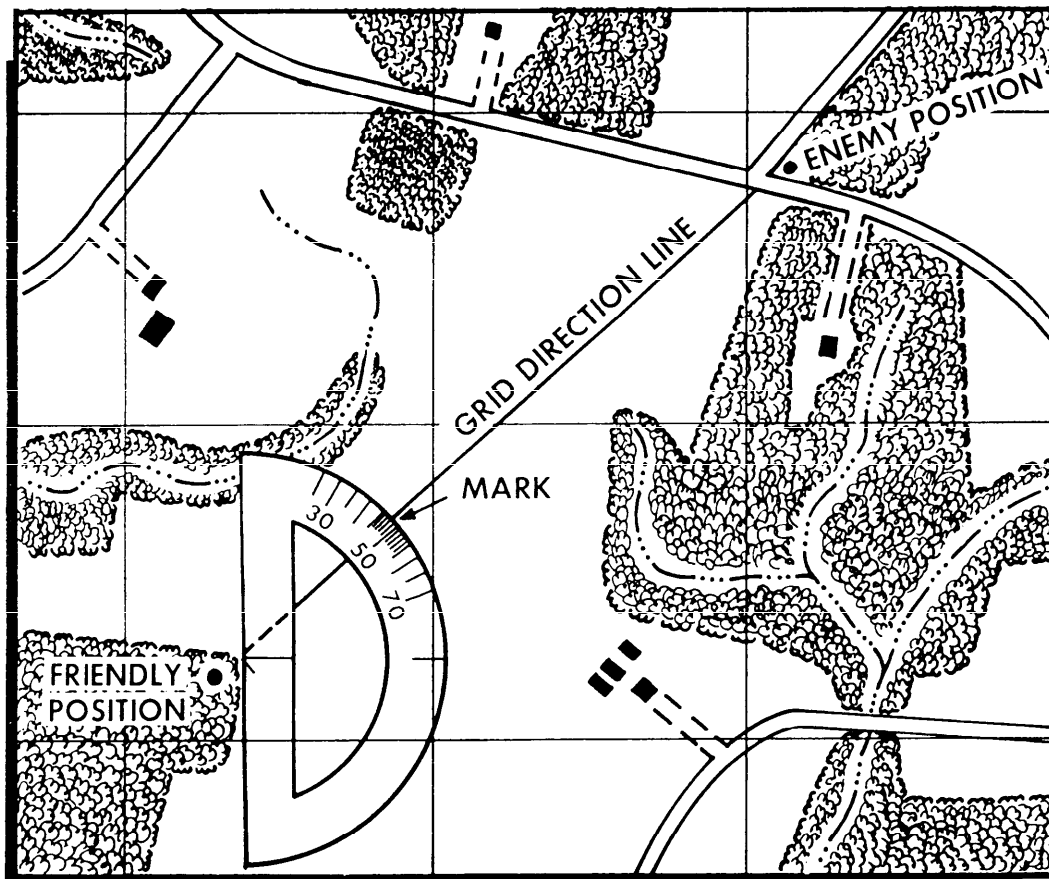

Figure 20-60. Plotting an Azimuth on a Map.

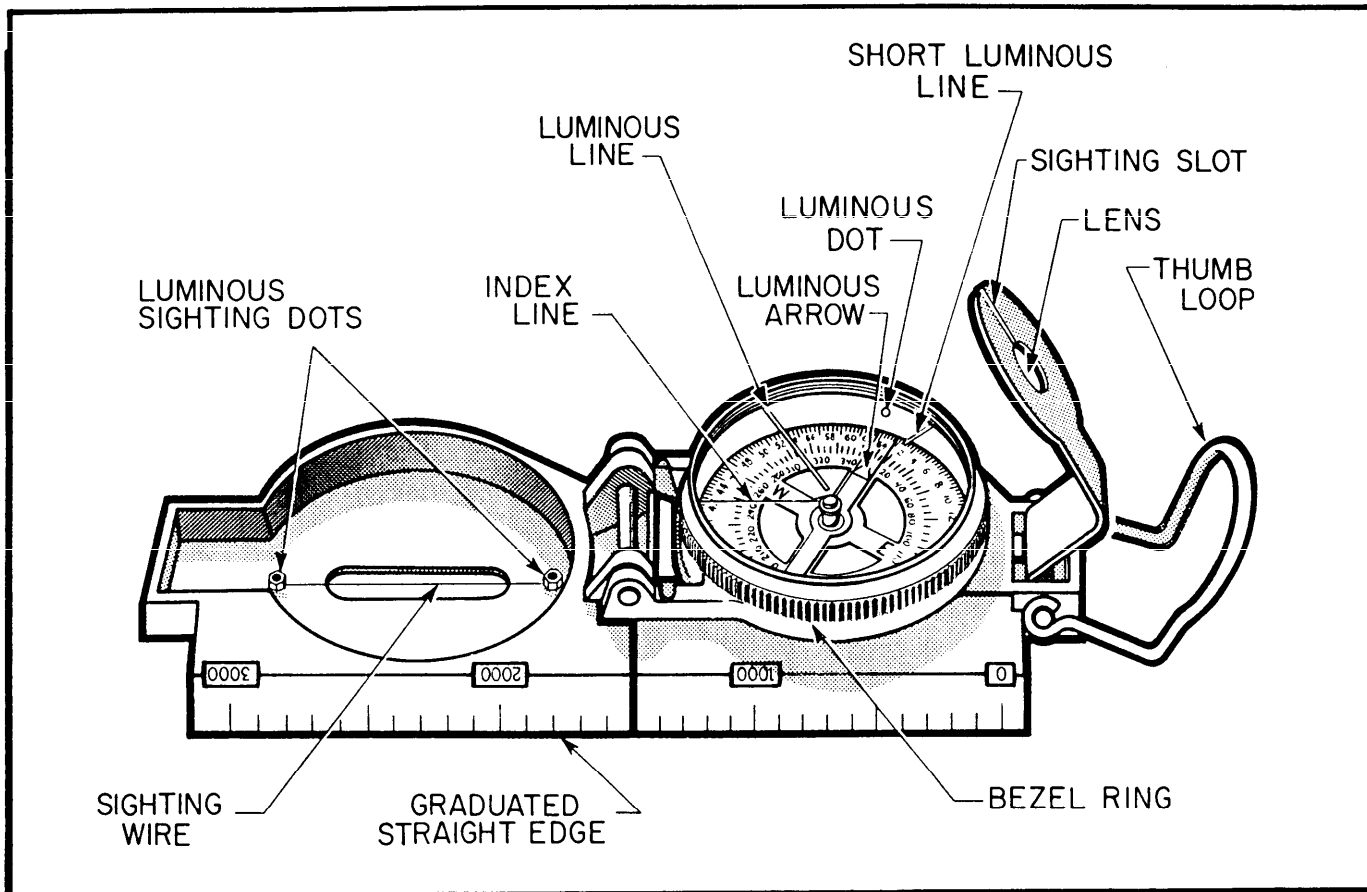

Figure 20-61. Lensatic Compass.



Figure 20-62. Holding the Compass.

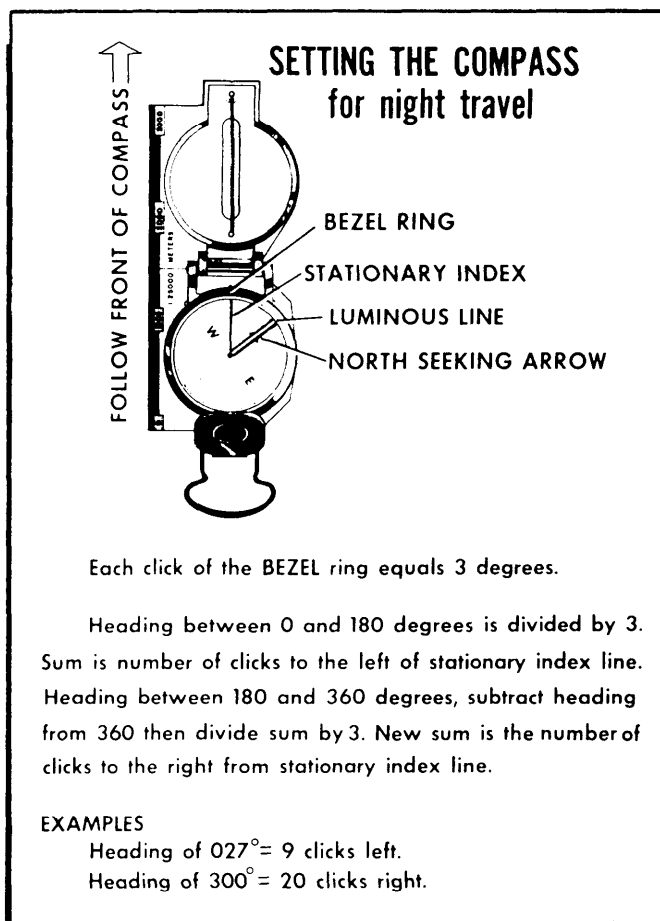

Figure 20-63. Night Travel.

(7) Map Orientation:

(a) A map is oriented when it is in a horizontal position with its north and south corresponding to north and south on the ground. The best way to orient a map is with a compass. (NOTE: Caution should be used to ensure nothing (metal, mine ore, etc.) in the area will alter the compass reading.)

(b) With the map in a horizontal position, the lensatic compass is placed parallel to a north-south grid line with the cover side of the compass pointing toward the top of the map. This will place the black index line on the dial of the compass parallel to grid north. Since the needle on the compass points to magnetic north, a declination diagram is (on the face of the compass) formed by the index line and the compass needle.

(c) Rotate the map and compass until the directions of the declination diagram formed by the black index line and compass needle match the directions shown on the declination diagram printed in the margin of the map. The map is then oriented (grid north).

(d) If the magnetic north arrow on the map is to the left of grid north, the compass reading will equal the G-M angle (given in the declination diagram). If the

magnetic north is to the right of grid north, the compass reading will equal 360° minus the G-M angle. In figure 20-64, the declination diagram illustrates a magnetic north to the right of grid north and the compass reading will be 360° minus $21\frac{1}{2}^\circ$ or $338\frac{1}{2}^\circ$.

(e) Remember to point the compass north arrow in the same direction as the magnetic north arrow, and the compass reading (equal to the G-M angle or the 360° minus G-M angle) will be quite apparent.

(f) In summary, if the variation is to the east of true north or the magnetic north arrow of the declination diagram is to the east (right) of the grid north line, subtract the degrees of variation from 360° . If it is to the left (west), add to 000° . East is least and west is best.

(g) If a grid line is not used, a true north-south line can be used. True north-south lines are longitudinal lines or lines formed by the vertical lines on a tick map (assuming the top of the map is north). The same procedure is used if magnetic variation is figured from true north—not grid north.

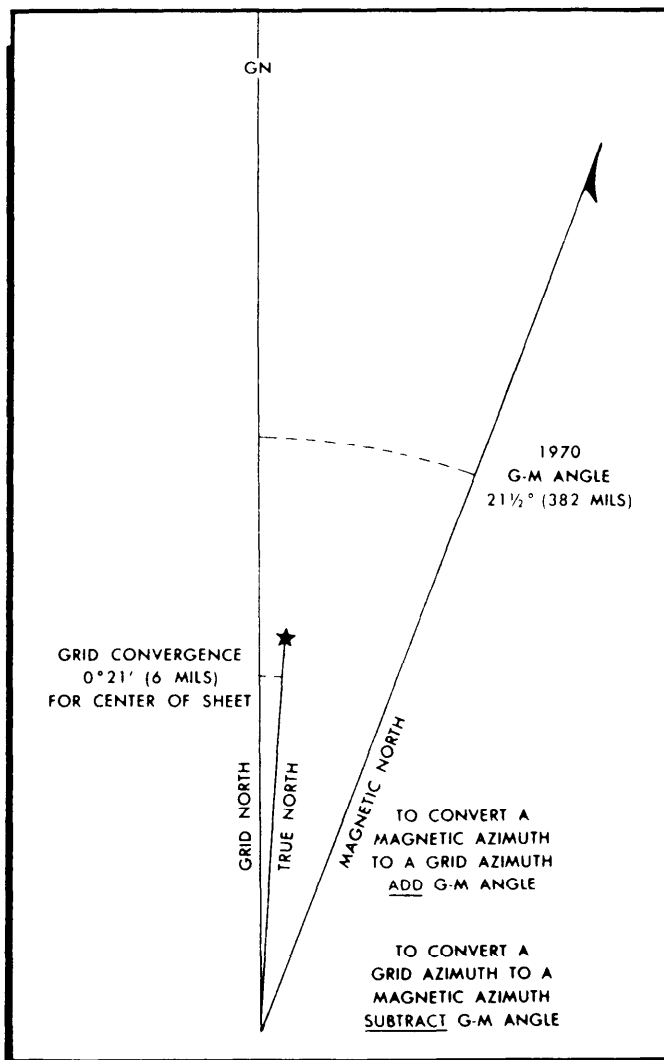

Figure 20-64. Declination Diagram.

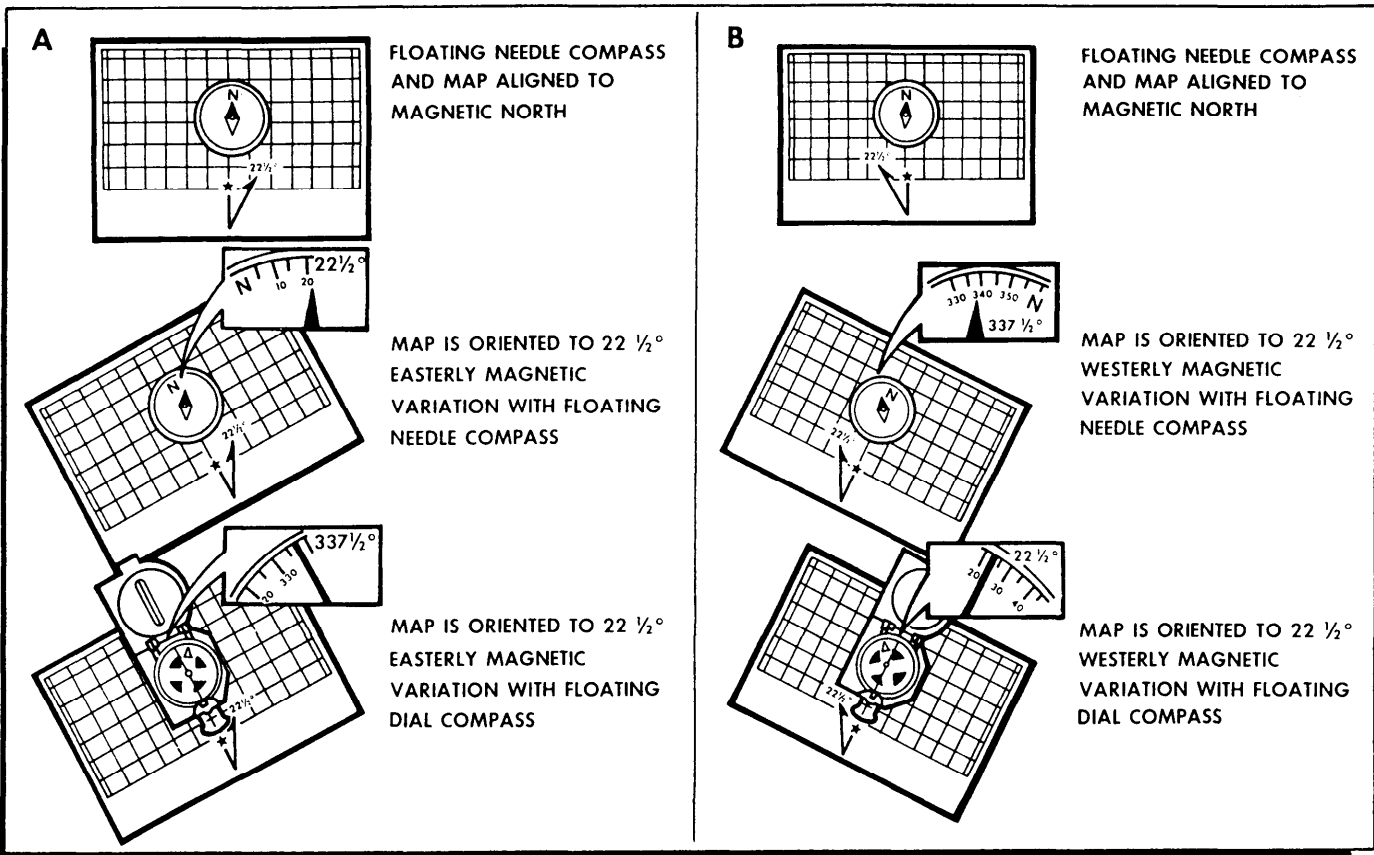

Figure 20-65. Floating Needle Compass.

(h) A floating needle compass (figures 20-65a and 20-65b) has a needle with a north direction marked on it. The degree and direction marks are stationary on the bottom inside of the compass. The button and wrist compasses may be floating dial or floating needle. To determine the heading, line up the north-seeking arrow over 360° by rotating the compass. Then read the desired heading. Orienting a map with a floating needle compass is similar to the method used with the floating dial. The only exception is with the adjustment for magnetic variation. If magnetic variation is to the east, turn the map and the compass to the left (the north axis of the compass should be aligned with the map north) so that the magnetic north-seeking arrow is pointing at the number of degrees on the compass which corresponds with the angle of declination.

(i) When a compass is not available, map orientation requires a careful examination of the map and the ground to find linear features common to both, such as roads, railroads, fence lines, power lines, etc. By aligning the feature on the map with the same feature on the ground (figure 20-66), the map is oriented. Orientation by this method must be checked to prevent the reversal of directions which may occur if only one linear feature is used. This reversal may be prevented by aligning two or more map features (terrain or manmade). If no sec-

ond linear feature is visible but the map user's position is known, a prominent object may be used. With the

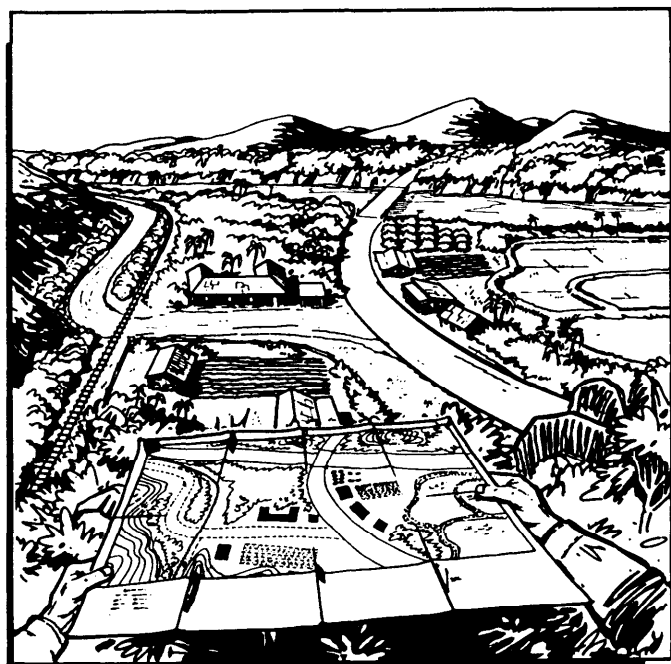

Figure 20-66. Map Orientation by Inspection.

prominent object and the user's position connected with a straight line on the map, the map is rotated until the line points toward the feature.

(j) If two prominent objects are visible and plotted on the map and the position is not known, move to one of the plotted and known positions, place the straightedge or protractor on the line between the plotted positions, turn the protractor and the map until the other plotted and visible point is seen along the edge. The map is then oriented.

(k) When a compass is not available and there are no recognizable prominent landforms or other features, a map may be oriented by any of the field expedient methods we will now discuss.

(8) Determining Cardinal Directions Using Field Expedients:

*(a) Shadow tip method of determining direction and time. This simple method of finding direction by the Sun consists of only three basic steps (figure 20-67).

-1. Step 1. Place a stick or branch into the ground at a fairly level spot where a distinct shadow will be cast. Mark the shadow tip with a stone, twig, or other means.

-2. Step 2. Wait until the shadow tip moves a few inches. If a 4-foot stick is being used, about 10 minutes should be sufficient. Mark the new position of the shadow tip in the same way as the first.

-3. Step 3. Draw a straight line through the two marks to obtain an approximate east-west line. If uncertain which direction is east and which is west, observe this simple rule: The Sun "rises in the east and sets in the west" (but rarely DUE east and DUE west). The shadow tip moves in just the opposite direction. Therefore, the first shadow-tip mark is always in the west direction, and the second mark in the east direction, anyplace on Earth.

(b) A line drawn at right angles to the east-west line at any point is the approximate north-south line, which will help orient a person to any desired direction of travel.

(c) Inclining the stick to obtain a more convenient shadow does not impair the accuracy of the shadow-tip method. Therefore, a traveler on sloping ground or in highly vegetated terrain need not waste valuable time looking for a large level area. A flat spot, the size of the hand, is all that is necessary for shadow-tip markings and the base of the stick can be either above, below, or to one side of it. Also, any stationary object (the end of a tree limb or the notch where branches are joined) serves just as well as an implanted stick because only

*From *Better Ways of Pathfinding*, by Robert S. Owendoff, 153 Cundry Drive, Falls Church VA 22046. 1964§ by Stackpole Company, Harrisburg PA. All rights reserved by copyright owner (author).

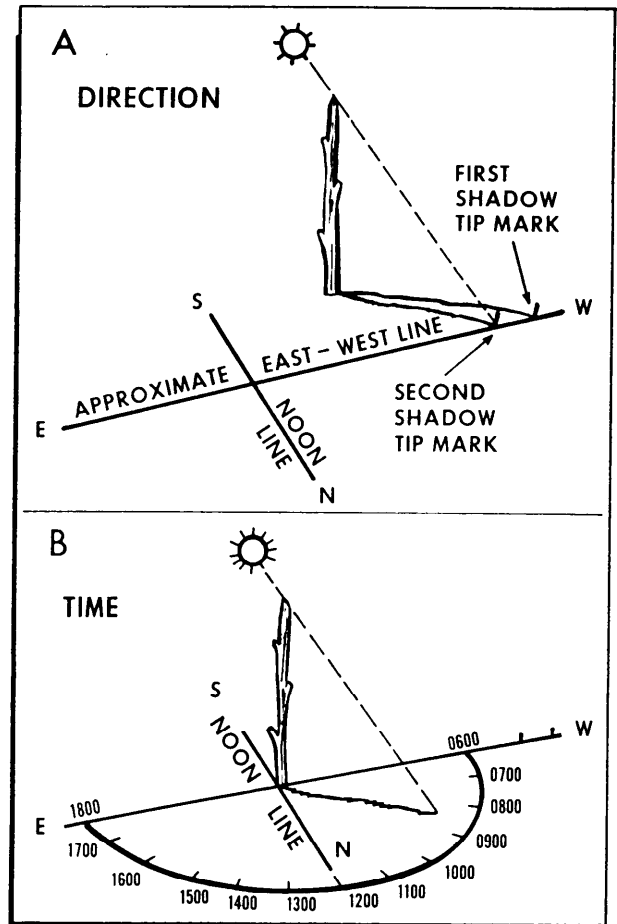

Figure 20-67. Determining Time and Direction by Shadow.

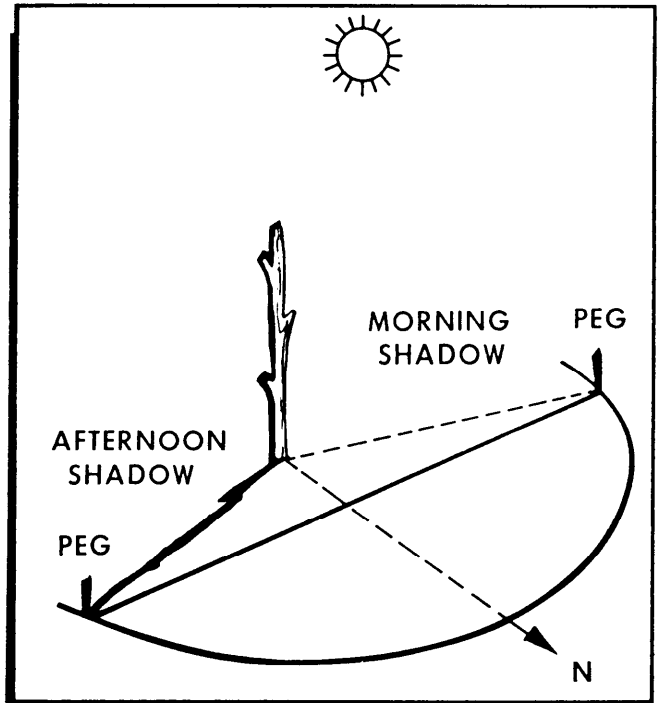
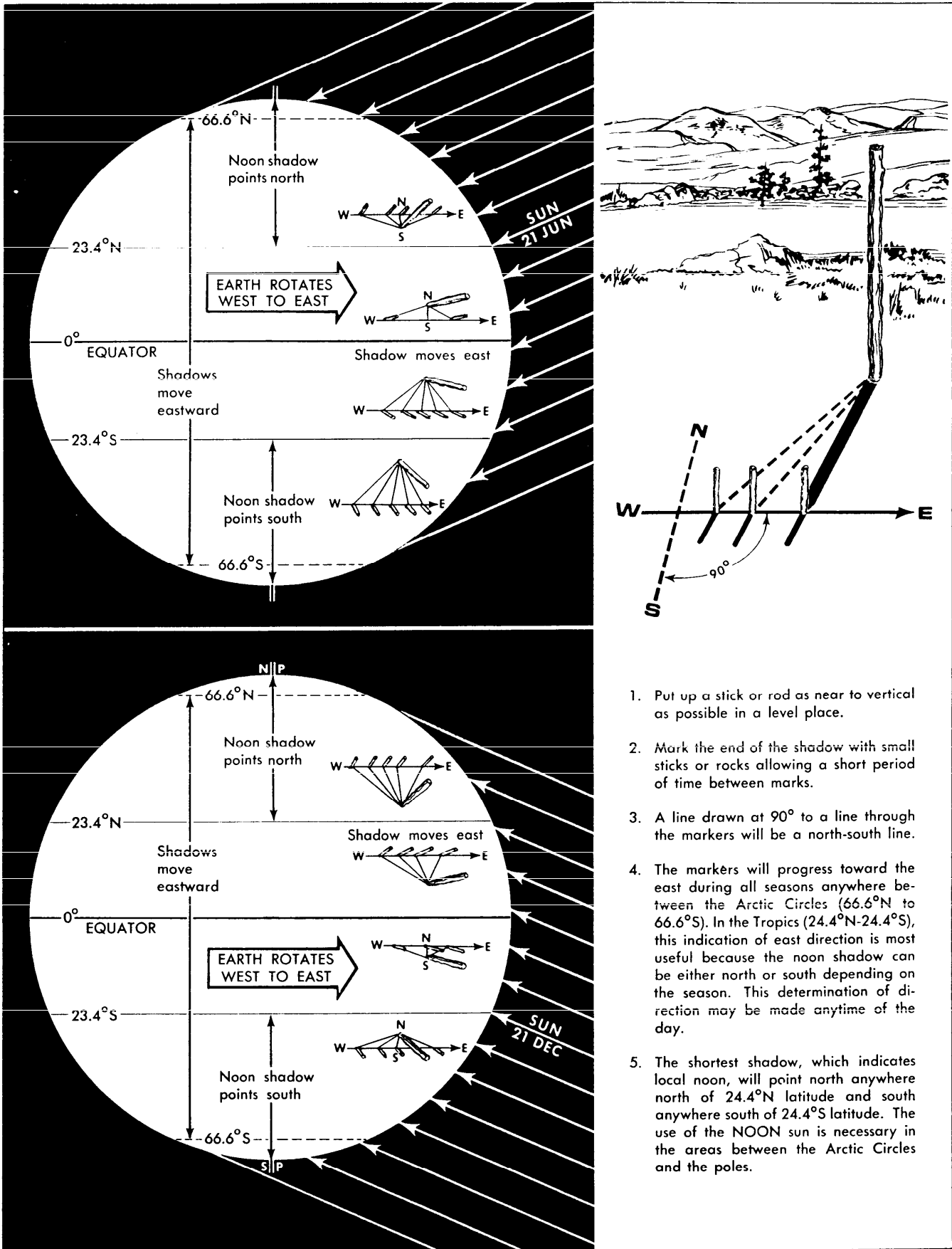

Figure 20-68. Equal Shadow Method of Determining Direction.



1. Put up a stick or rod as near to vertical as possible in a level place.
2. Mark the end of the shadow with small sticks or rocks allowing a short period of time between marks.
3. A line drawn at 90° to a line through the markers will be a north-south line.
4. The markers will progress toward the east during all seasons anywhere between the Arctic Circles (66.6°N to 66.6°S). In the Tropics (24.4°N-24.4°S), this indication of east direction is most useful because the noon shadow can be either north or south depending on the season. This determination of direction may be made anytime of the day.
5. The shortest shadow, which indicates local noon, will point north anywhere north of 24.4°N latitude and south anywhere south of 24.4°S latitude. The use of the NOON sun is necessary in the areas between the Arctic Circles and the poles.

Figure 20-69. Stick and Shadow Method of Determining Direction.

the shadow tip is marked.

(d) The shadow-tip method can also be used to find the approximate time of day (figure 20-67B).

-1. To find the time of day, move the stick to the intersection of the east-west line and the north-south line, and set it vertically in the ground. The west part of the east-west line indicates the time is 0600 and the east part is 1800, ANYWHERE on Earth, because the basic rule always applies.

-2. The north-south line now becomes the noon line. The shadow of the stick is an hour hand in the shadow clock and with it the time can be estimated using the noon line and 6 o'clock line as the guides. Depending on the location and the season, the shadow may move either clockwise or counterclockwise, but this does not alter the manner of reading the shadow clock.

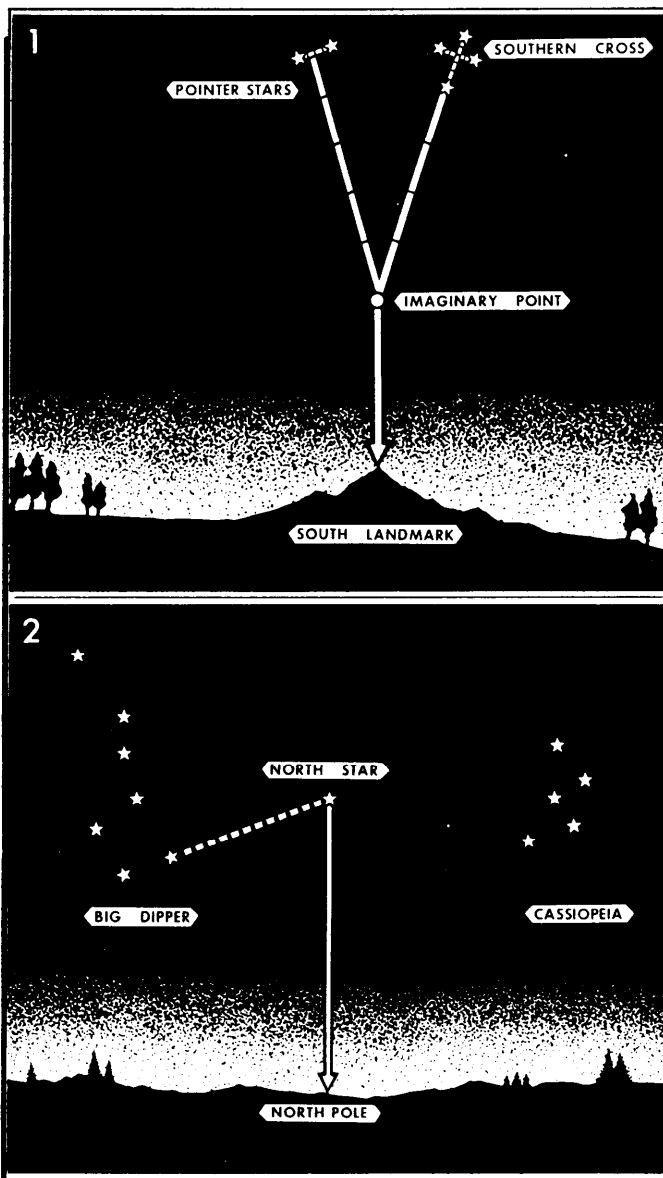

Figure 20-70. Determination of Direction by Using the Stars.

-3. The shadow clock is not a timepiece in the ordinary sense. It always reads 0600 at sunrise and 1800 at sunset. However, it does provide a satisfactory means of telling time in the absence of properly set watches. Being able to establish the time of day is important for such purposes as keeping a rendezvous, prearranged concerted action by separated persons or groups, and estimating the remaining duration of daylight. Shadow-clock time is closest to conventional clock time at mid-day, but the spacing of the other hours, compared to conventional time, varies somewhat with the locality and date.

(e) The shadow-tip system is ineffective for use beyond $66\frac{1}{2}^\circ$ latitude in either hemisphere due to the position of the Sun above the horizon. Whether the Sun is north or south of a survivor at mid-day depends on the latitude. North of 23.4°N , the Sun is always due south at local noon and the shadow points north. South of 23.4°S , the Sun is always due north at local noon and the shadow points south. In the tropics, the Sun can be either north or south at noon, depending on the date and location but the shadow progresses to the east regardless of the date.

(f) Equal-shadow method of determining direction (Figures 20-68 and 20-69). This variation of the shadow-tip method is more accurate and may be used at all latitudes less than 66° at all times of the year.

-1. Step 1. Place a stick or branch into the ground vertically at a level spot where a shadow at least 12 inches long will be cast. Mark the shadow tip with a stone, twig, or other means. This must be done 5 to 10 minutes before noon (when the Sun is at its highest point (zenith)).

-2. Step 2. Trace an arc using the shadow as the radius and the base of the stick as the center. A piece of string, shoelace, or a second stick may be used to do this.

-3. Step 3. As noon is approached, the shadow becomes shorter. After noon, the shadow lengthens until it crosses the arc. Mark the spot as soon as the shadow tip touches the arc a second time.

-4. Step 4. Draw a straight line through the two marks to obtain an east-west line.

(g) Although this is the most accurate version of the shadow-tip method, it must be performed around noon. It requires the observer to watch the shadow and complete step 3 at the exact time the shadow tip touches the arc.

(h) At night, the stars may be used to determine the north line in the northern hemisphere or the south line in the southern hemisphere. Figure 20-70 shows how this is done.

(i) A watch can be used to determine the approximate true north or south (figure 20-71). In the northern hemisphere, the hour hand is pointed toward the Sun. A south line can be found midway between the hour hand

and 1200 standard time. During daylight savings time, the north-south line is midway between the hour hand and 1300. If there is any doubt as to which end of the line is north, remember that the Sun is in the east before noon and in the west in the afternoon.

(j) The watch may also be used to determine direction in the Southern Hemisphere; however, the method is different. The 1200-hour dial is pointed toward the Sun, and halfway between 1200 and the hour hand will be a north line. During daylight savings time, the north line lies midway between the hour hand and 1300.

(k) The watch method can be in error, especially in the extreme latitudes, and may cause "circling." To avoid this, make a shadow clock and set the watch to the time indicated. After traveling for an hour, take another shadow-clock reading.

(9) Determining Specific Position. When using a map and compass, the map must be oriented using the method described earlier in this chapter. Next, locate two or three known positions on the ground and the map. Using the compass, shoot an azimuth to one of the known positions (figure 20-72). Once the azimuth is

determined, recheck the orientation of the map and plot the azimuth on the map. To plot the azimuth, place the front corner of the straightedge of the compass on the corresponding point on the map. Rotate the compass until the determined azimuth is directly beneath the stationary index line. Then draw a line along the straightedge of the compass and extend the line past the estimated position on the map. Repeat this procedure for the second point (figure 20-72). If only two azimuths are used, the technique is referred to as biangulation (figure 20-72). If a third azimuth is plotted to check the accuracy of the first two, the technique is called triangulation (figure 20-72). When using three lines, a triangle of error may be formed. If the triangle is large, the work should be checked. However, if a small triangle is formed, the user should evaluate the terrain to determine the actual position. One azimuth may be used with a linear land feature such as a river, road, railroad, etc., to determine specific position (figure 20-72).

(10) Determining Specific Location Without a Compass. A true north-south line determined by the stick and shadow, Sun and watch, or celestial constella-

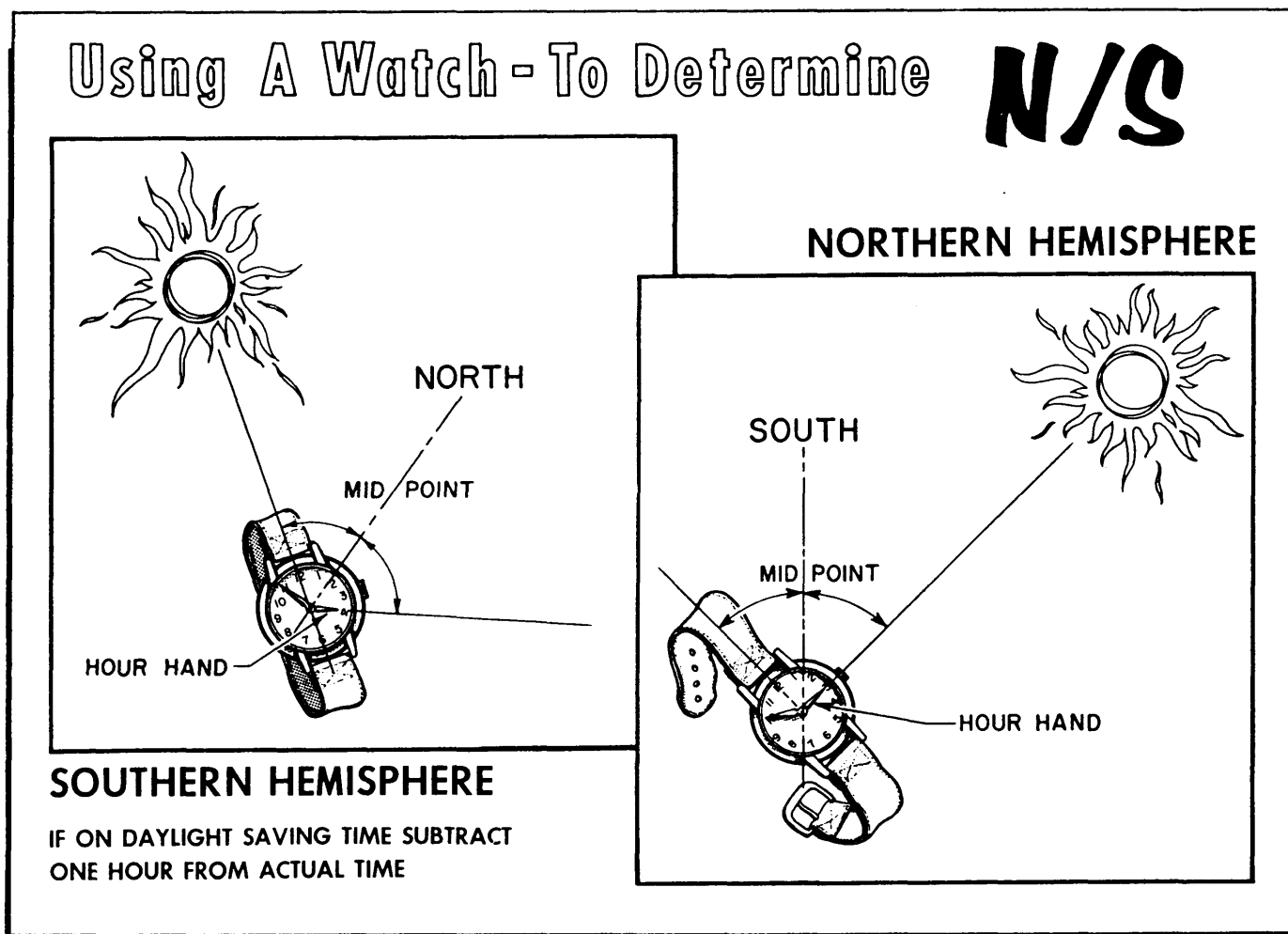

Figure 20-71. Directions Using a Watch.

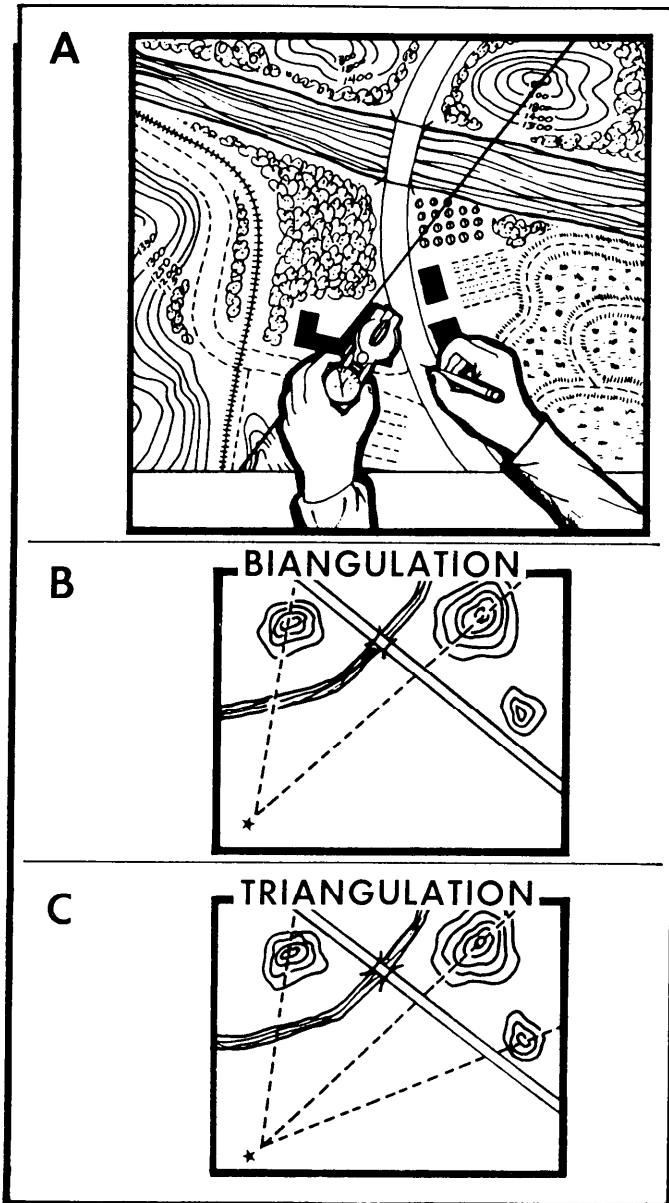

Figure 20-72. Azimuth, Biangulation, and Triangulation.

tion method may be used to orient the map without a compass. However, visible major land features can be used to orient the map to the lay of the land. Once the map is oriented, identify two or three landmarks and mark them on the map. Lay a straightedge on the map with the center of the straightedge at a known position as a pivot point and rotate the straightedge until the known position of the map is aligned with present position, and draw a line. Repeat this for the second and third position. Each time a line of position is plotted, the map must still be aligned with true north and south. If three lines of position are plotted and form a small triangle, use terrain evaluation to determine present position. If they form a large triangle, recheck calculations for errors.

(11) Dead Reckoning:

(a) Dead reckoning is the process of locating one's position by plotting the course and distance from the last known location. In areas where maps exist, even poor ones, travel is guided by them. It is a matter of knowing one's position at all times by associating the map features with the ground features. A great portion of the globe is unmapped or only small scale maps are available. The survivor may be required to travel in these areas without a usable map. Although these areas could be anywhere, they are more likely to be found in frozen wastelands and deserts.

(b) For many centuries, mariners used dead reckoning to navigate their ships when they were out of sight of land or during bad weather, and it is just as applicable to navigation on land. Movement on land must be carefully planned. In military movement, the starting location and destination are known, and if a map is available, they are carefully plotted along with any known intermediate features along the route. These intermediate features, if clearly recognizable on the ground, serve as checkpoints. If a map is not available, the plotting is done on a blank sheet of paper. A scale is selected so the entire route will fit on one sheet. A north direction is clearly established. The starting point and destination are then plotted in relationship to each other. If the terrain and enemy situations permit, the ideal course is a straight line from starting point to destination. This is seldom possible or practicable. The route of

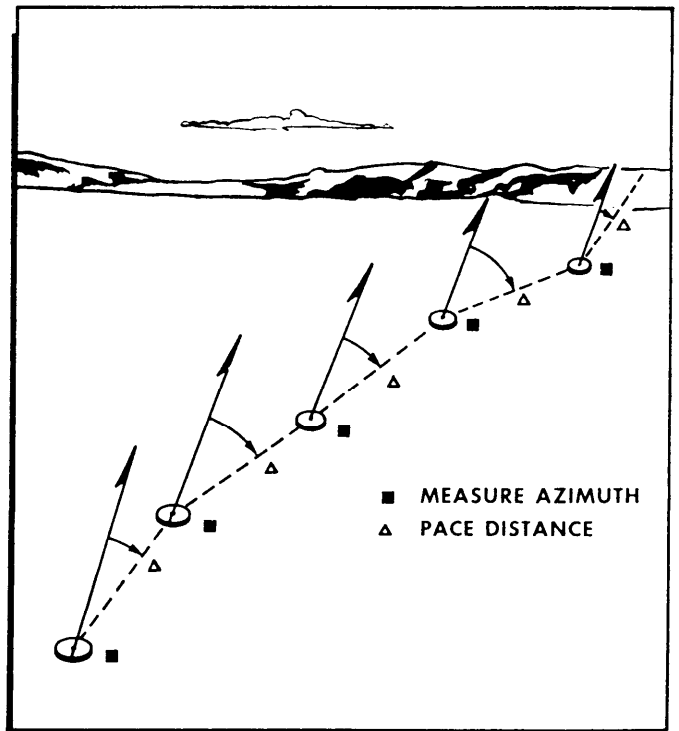

Figure 20-73. Compass Navigation on Foot.

1	2	3	4	5	6	7
ODOMETER READING AT START OF EACH COURSE	DISTANCE IN MILES	FORWARD AZIMUTH (MAGNETIC)	DECLINATION CORRECTION	DEVIATION CORRECTION	TRUE AZIMUTH	NOTES
A 4750						
	6	17°	13°	+3°	33°	
B 4756						
	9	358°	"	+2°	13°	
C 4765						
	8	341°	"	+1°	355°	
D 4773						
	1	314°	"	0°	327°	
E 4774						
	1.5	341°	"	+1°	355°	
F 4775						
	1.5	322°	"	0°	335°	
G 4777						
	1	312°	"	0°	325°	
H 4778						
	12	300°	12°	-1°	311°	
I 4790						
	6	341°	"	+1°	354°	
J 4796						
	6	302°	"	-1°	313°	
K 4802						
	20	319°	"	0°	331°	
4810						Wahoo River
						Crossing
4814						Cut 2 miles
L 4824			Base Camp (data)			

Figure 20-74. Sample Log.

travel usually consists of several courses, with an azimuth established at the starting point for the first course to be followed. Distance measurement begins with the departure and continues through the first course until a change in direction is made. A new azimuth is established for the second course and the distance is measured until a second change of direction is made, and so on. Records of all data are kept and all positions are plotted.

(c) A pace (for our purposes) is equal to the distance covered every time the same foot touches the ground (surveyor's paces). To measure distance, count the number of paces in a given course and convert to the map unit. Usually, paces are counted in hundreds, and hundreds can be kept track of in many ways: mak-

ing notes in a record book; counting individual fingers; placing small objects such as pebbles into an empty pocket; tying knots in a string; or using a mechanical hand counter. Distances measured this way are only approximate, but with practice can become very accurate. It is important that each person who uses dead reckoning navigation establish the length of an average pace. This is done by pacing a measured course many times and computing the mean (figure 20-73). In the field, an average pace must often be adjusted because of the following conditions:

- 1. Slopes. The pace lengthens on a downgrade and shortens on an upgrade.
- 2. Winds. A headwind shortens the pace while a tailwind increases it.

- 3. Surfaces. Sand, gravel, mud and similar surface materials tend to shorten the pace.
- 4. Elements. Snow, rain, or ice reduces the length of the pace.
- 5. Clothing. Excess weight of clothing shortens the pace while the type of shoes affects traction and therefore the pace length.

(d) A log (figure 20-74) should be used for navigation, by dead reckoning, to record all of the distances and azimuths while traveling. Often, relatively short stretches of travel cannot be traversed in a straight course because of some natural features such as a river, or a steep, rugged slope. This break in normal navigation is shown on the log to ensure proper plotting.

(e) The course of travel may be plotted directly on the face of the map or on a separate piece of paper at the same scale as the map. If the latter method is chosen, the complete plot can be transferred to the map sheet, if at least one point of the plot is also shown on the map. The actual plotting can be done by protractor and scale. The degree of accuracy obtained depends upon the quality of draftmanship, the environmental conditions, and the care taken in obtaining data while en

route. Figure 20-75 illustrates a paper plot of the data obtained for the log sample in figure 20-74. It should be noted that four of the courses from A to H are short and have been plotted as a single course, equal to the sum of the four distances and using a mean azimuth of the four. This is recommended because it saves time without a loss of accuracy. If possible, a plot should be tied into at least one known intermediate point along the route. This is done by directing the route to pass near or over a point. If the plotted position of the intermediate point differs from its known location, discard the previous plot and start a new plot from the true location. The previous plot may be inspected to see if there is a detectable constant error applicable to future plots; otherwise, it is of no further use.

(f) An offset is a planned magnetic deviation to the right or left of an azimuth to an objective. It is used when approaching a linear feature from the side, and a point along the linear feature (such as a road junction) is the objective. Because of errors in the compass, or in map reading, one may reach the linear feature and not know whether the objective lies to the right or left. A deliberate offset by a known number of degrees in a known direction compensates for possible errors and ensures that, upon reaching the linear feature, the user knows whether to go right or left to reach the objective.

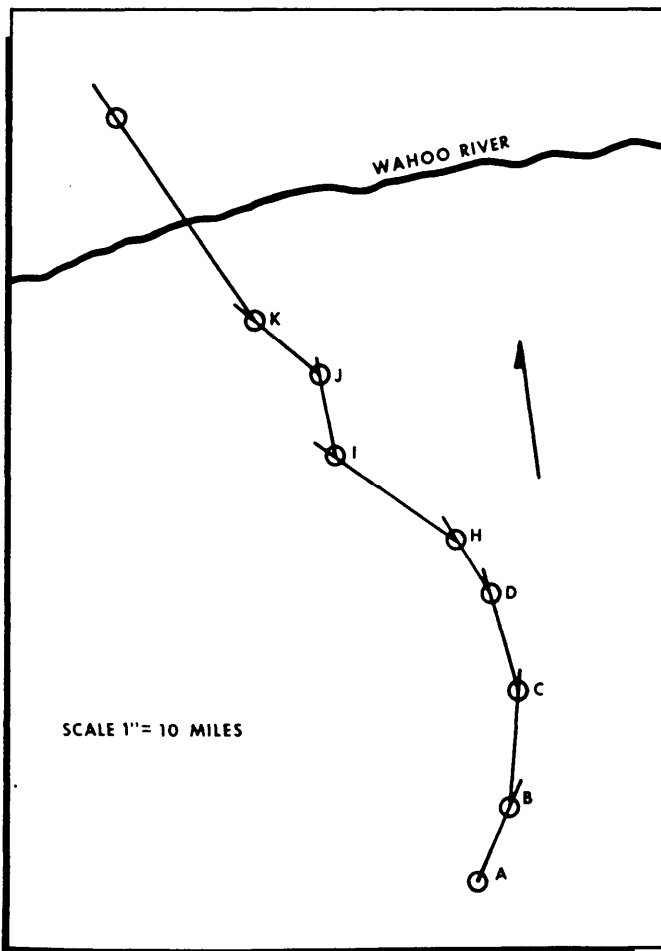

Figure 20-75. Separate Paper Plot.

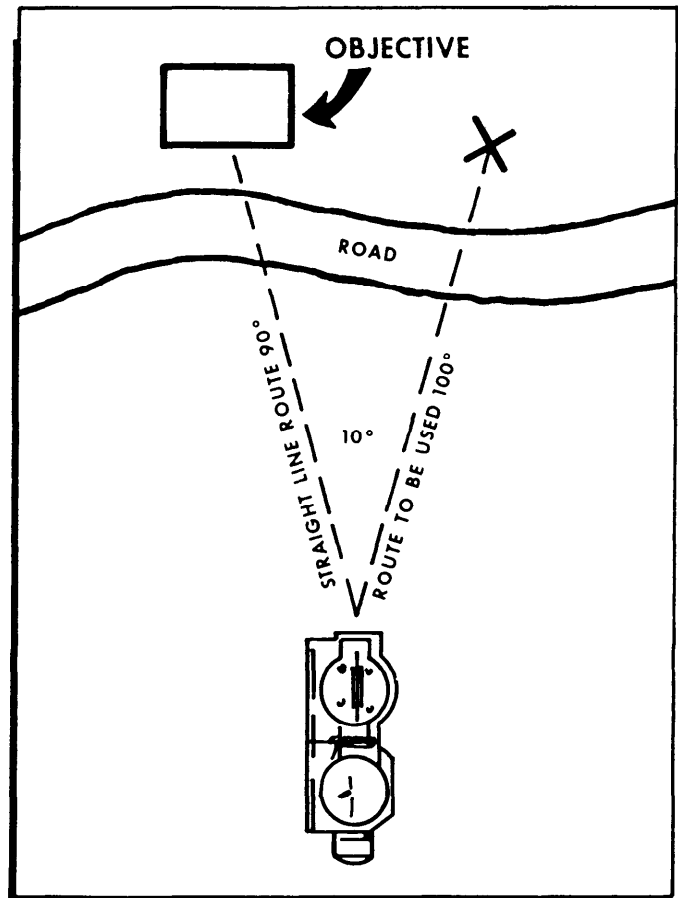
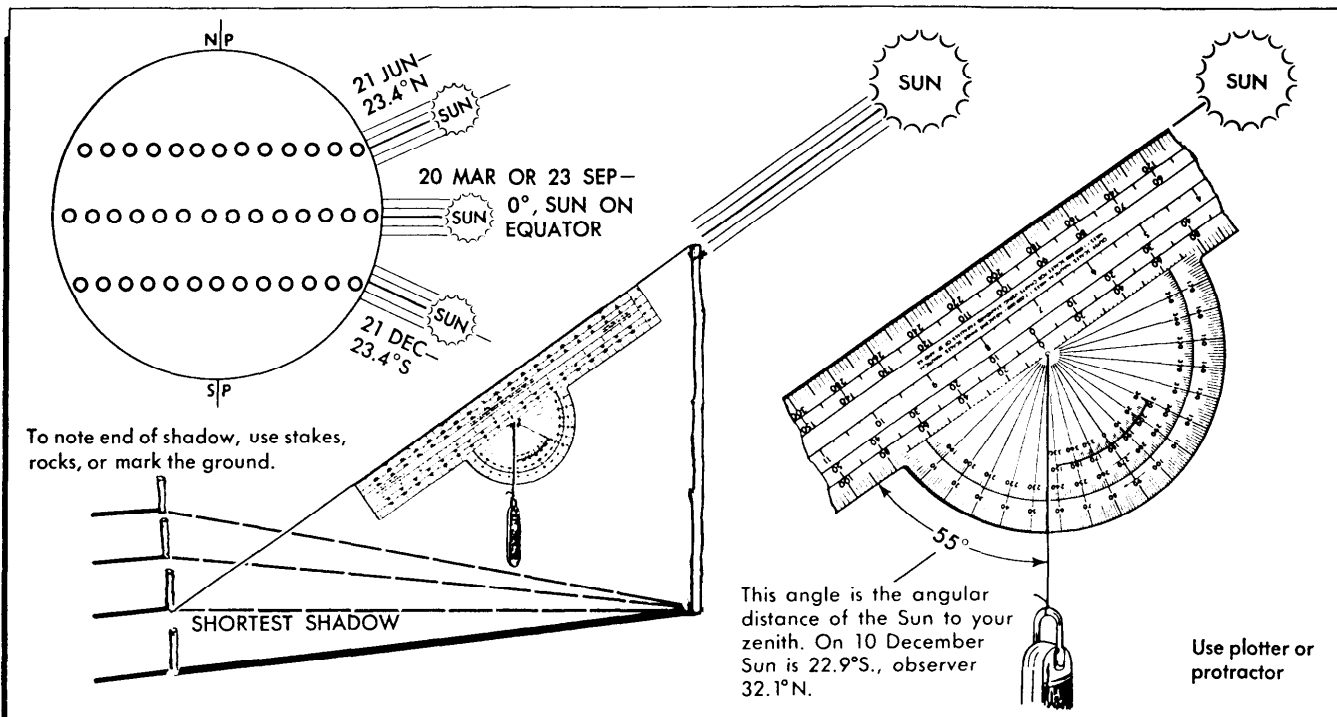

Figure 20-76. Deliberate Offset.

DATE		Angle to North from the rising or setting Sun (level terrain)												
		LATITUDE												
		0°	5°	10°	15°	20°	25°	30°	35°	40°	45°	50°	55°	60°
JANUARY	1	113	113	113	114	115	116	117	118	121	124	127	133	141
	6	112	113	113	113	114	115	116	118	120	123	127	132	140
	11	112	112	112	113	113	114	115	117	119	122	125	130	138
	16	111	111	111	112	112	113	114	116	118	120	124	129	136
FEBRUARY	1	110	110	110	111	111	112	113	115	117	119	122	127	133
	6	109	109	109	109	110	111	112	113	115	117	120	124	130
	11	107	107	108	108	108	109	110	111	113	115	117	121	126
	16	106	106	106	106	107	107	108	109	111	113	115	118	123
MARCH	1	104	104	105	105	105	106	107	108	109	110	112	116	120
	6	103	103	103	103	103	104	105	106	107	108	110	112	116
	11	101	101	101	101	101	102	102	103	104	105	107	109	112
	16	99	99	99	99	100	100	100	101	102	103	104	106	108
APRIL	1	98	98	98	98	99	99	99	100	100	101	102	104	106
	6	96	96	96	96	96	97	97	97	98	98	99	100	102
	11	94	94	94	94	94	94	95	95	95	96	96	97	98
	16	92	92	92	92	92	92	92	92	93	93	93	93	94
MAY	1	90	90	90	90	90	90	90	90	90	90	90	90	90
	6	88	88	88	88	88	88	88	88	87	87	87	87	86
	11	86	86	86	86	85	85	85	85	84	84	83	82	81
	16	84	84	84	83	83	83	83	82	82	81	80	79	77
JUNE	1	82	82	82	82	81	81	81	80	80	79	77	76	74
	6	80	80	80	80	79	79	78	78	77	76	74	72	70
	11	78	78	78	78	78	77	76	76	75	73	72	69	66
	16	77	77	76	76	76	75	75	74	72	71	69	66	63
JULY	1	75	75	75	74	74	73	73	72	70	69	66	63	59
	6	74	74	73	73	73	72	71	70	68	67	64	61	56
	11	72	72	72	72	71	70	69	68	67	65	62	58	52
	16	71	71	71	70	70	69	68	67	65	63	60	55	49
AUGUST	1	70	70	70	69	69	68	67	65	63	61	58	53	47
	6	69	69	69	68	68	67	66	64	62	60	56	51	44
	11	68	68	68	67	66	66	64	63	61	58	54	49	41
	16	67	67	67	66	65	64	63	62	59	56	53	47	39
SEPTEMBER	1	67	67	67	66	65	64	63	62	59	56	53	47	39
	6	67	67	67	66	66	65	64	62	60	57	53	48	40
	11	68	68	68	67	66	65	64	63	61	58	54	49	41
	16	69	68	68	68	67	66	65	64	62	59	55	50	43
OCTOBER	1	69	69	69	69	68	67	66	65	63	60	57	52	45
	6	70	70	70	70	69	68	67	66	64	62	59	54	48
	11	72	72	72	71	71	70	69	68	66	64	61	57	51
	16	73	73	73	73	72	71	71	69	68	66	63	60	55
NOVEMBER	1	75	75	74	74	74	73	72	71	70	68	66	63	58
	6	76	76	76	76	75	75	74	73	72	70	68	65	61
	11	78	78	77	77	77	76	76	75	74	72	71	68	65
	16	79	79	79	79	79	78	78	77	76	75	73	71	68
DECEMBER	1	82	82	82	81	81	81	80	80	79	78	77	75	73
	6	83	83	83	83	83	83	82	82	81	81	80	78	77
	11	85	85	85	85	85	85	85	84	84	83	83	82	81
	16	87	87	87	87	87	87	87	86	86	86	85	85	84
JANUARY	1	89	89	89	89	89	89	89	89	89	89	88	88	88
	6	91	91	91	91	91	91	91	91	91	91	92	92	92
	11	93	93	93	93	93	93	93	94	94	94	95	95	96
	16	95	95	95	95	95	95	96	96	97	97	98	99	100
FEBRUARY	1	97	97	97	97	97	98	98	99	99	100	101	102	104
	6	99	99	99	99	99	100	100	101	101	102	104	105	108
	11	101	101	101	101	101	102	102	103	104	105	107	109	112
	16	102	102	103	103	103	104	104	105	106	108	109	112	115
MARCH	1	104	104	105	105	105	106	107	108	109	110	113	116	120
	6	106	106	106	107	107	108	109	110	111	113	115	119	123
	11	107	107	108	108	108	109	110	111	113	115	117	121	126
	16	109	109	109	109	110	111	112	113	115	117	120	124	130
APRIL	1	110	110	110	111	111	112	113	114	116	118	119	122	133
	6	111	111	111	112	112	113	114	116	118	120	124	128	135
	11	112	112	112	113	113	114	115	117	119	122	126	130	138
	16	113	113	113	114	115	116	117	118	121	124	127	133	141
MAY	1	113	113	113	114	115	116	117	118	121	124	127	133	141
	6	112	112	112	113	113	114	115	116	118	120	123	126	140
	11	112	112	112	113	113	114	115	116	118	120	123	126	140
	16	113	113	113	114	115	116	117	118	121	124	127	133	141
JUNE	1	113	113	113	114	115	116	117	118	121	124	127	133	141
	6	113	113	113	114	115	116	117	118	121	124	127	133	141
	11	113	113	113	114	115	116	117	118	121	124	127	133	141
	16	113	113	113	114	115	116	117	118	121	124	127	133	141

NOTE: When the Sun is rising, the angle is reckoned from East to North.
When the Sun is setting, the angle is reckoned from West to North.

Figure 20-79. Finding Direction from the Rising or Setting Sun.



DECLINATION OF SUN

(IN DEGREES AND TENTHS OF A DEGREE)

Declination is tabulated to the nearest tenth of a degree rather than to the nearest minute of arc. To convert 1/10° (0.1°) to minutes, multiply by 6. (ie. 27.9° = 27° 54')

DAY	JAN	FEB	MAR	APR	MAY	JUN	JUL	AUG	SEP	OCT	NOV	DEC
1	S 23.1	S 17.5	S 7.7	N 4.4	N 15.0	N 22.0	N 23.1	N 18.1	N 8.4	S 3.1	S 14.3	S 21.8
2	23.0	17.2	7.3	4.8	15.3	22.1	23.1	17.9	8.1	3.4	14.6	21.9
3	22.9	16.9	6.9	5.2	15.6	22.3	23.0	17.6	7.7	3.8	15.0	22.1
4	22.9	16.6	6.6	5.6	15.9	22.4	22.9	17.3	7.3	4.2	15.3	22.2
5	22.8	16.3	6.2	5.9	16.2	22.5	22.8	17.1	7.0	4.6	15.6	22.3
6	S 22.7	S 16.0	S 5.8	N 6.3	N 16.4	N 22.6	N 22.7	N 16.8	N 6.6	S 5.0	S 15.9	S 22.5
7	22.5	15.7	5.4	6.7	16.7	22.7	22.6	16.5	6.2	5.4	16.2	22.6
8	22.4	15.4	5.0	7.1	17.0	22.8	22.5	16.3	5.8	5.7	16.5	22.7
9	22.3	15.1	4.6	7.4	17.3	22.9	22.4	16.0	5.5	6.1	16.8	22.8
10	22.2	14.8	4.2	7.8	17.5	23.0	22.3	15.7	5.1	6.5	17.1	22.9
11	S 22.0	S 14.5	S 3.8	N 8.2	N 17.8	N 23.1	N 22.2	N 15.4	N 4.7	S 6.9	S 17.3	S 23.0
12	21.9	14.1	3.5	8.6	18.0	23.1	22.0	15.1	4.3	7.3	17.6	23.1
13	21.7	13.8	3.1	8.9	18.3	23.2	21.9	14.8	3.9	7.6	17.9	23.1
14	21.5	13.5	2.7	9.3	18.5	23.2	21.7	14.5	3.6	8.0	18.1	23.2
15	21.4	13.1	2.3	9.6	18.8	23.3	21.6	14.2	3.2	8.4	18.4	23.3
16	S 21.2	S 12.8	S 1.9	N 10.0	N 19.0	N 23.3	N 21.4	N 13.9	N 2.8	S 8.8	S 18.7	S 23.3
17	21.0	12.4	1.5	10.4	19.2	23.4	21.3	13.5	2.4	9.1	18.9	23.3
18	20.8	12.1	1.1	10.7	19.5	23.4	21.1	13.2	2.0	9.5	19.1	23.4
19	20.6	11.7	0.7	11.1	19.7	23.4	20.9	12.9	1.6	9.9	19.4	23.4
20	20.4	11.4	0.3	11.4	19.9	23.4	20.7	12.6	1.2	10.2	19.6	23.4
21	S 20.2	S 11.0	N 0.1	N 11.7	N 20.1	N 23.4	N 20.5	N 12.2	N 0.8	S 10.6	S 19.8	S 23.4
22	20.0	10.7	0.5	12.1	20.3	23.4	20.4	11.9	0.5	10.9	20.1	23.4
23	19.8	10.3	0.9	12.4	20.5	23.4	20.2	11.6	N 0.1	11.3	20.3	23.4
24	19.5	9.9	1.3	12.7	20.7	23.4	20.0	11.2	S 0.3	11.6	20.5	23.4
25	19.3	9.6	1.7	13.1	20.9	23.4	19.7	10.9	0.7	12.0	20.7	23.4
26	S 19.0	S 9.2	N 2.1	N 13.4	N 21.1	N 23.4	N 19.5	N 10.5	S 1.1	S 12.3	S 20.9	S 23.4
27	18.8	8.8	2.5	13.7	21.2	23.3	19.3	10.2	1.5	12.7	21.1	23.3
28	18.5	8.5	2.9	14.0	21.4	23.3	19.1	9.8	1.9	13.0	21.3	23.3
29	18.3	8.1	3.2	14.4	21.6	23.3	18.8	9.5	2.3	13.3	21.4	23.3
30	18.0	...	3.6	14.7	21.7	23.2	18.6	9.1	2.7	13.7	21.6	23.2
31	S 17.7	...	N 4.0	...	N 21.9	...	N 18.4	N 8.8	...	S 14.0	...	S 23.1

EXAMPLE: On 10 December the declination of the Sun is 22.9°S., so observers who measure the zenith distance as 0° would know that they are at latitude 22.9°S. If they measure a zenith distance

of 5° with the Sun south of this zenith, they are 5° north of 22.9°S, or at a latitude 17.9°S; and if the Sun is north, they are 5° south of 22.9°S, or latitude 27.9°S.

Figure 20-80. Determining Latitude by Noon Sun.

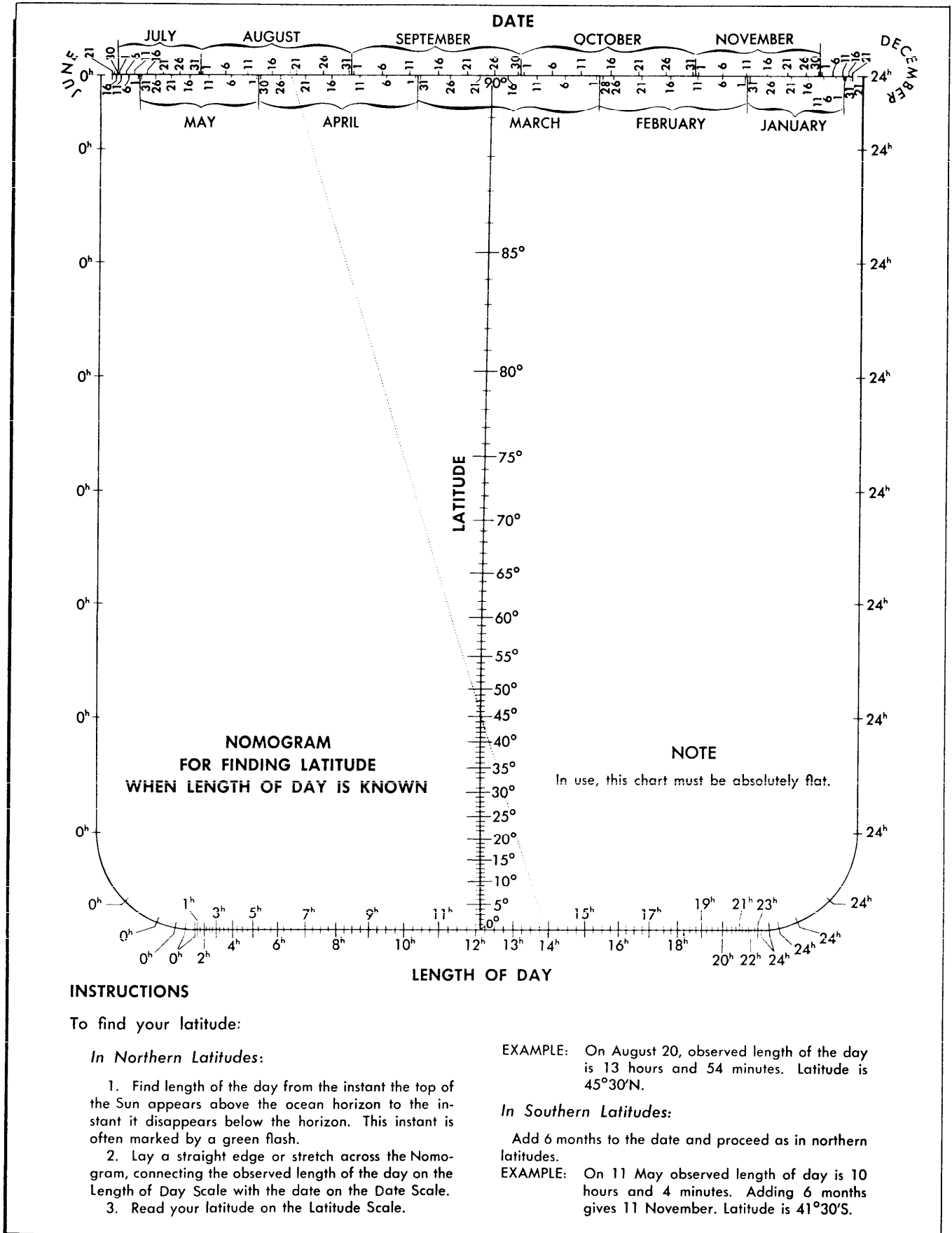

Figure 20-81. Nomogram.

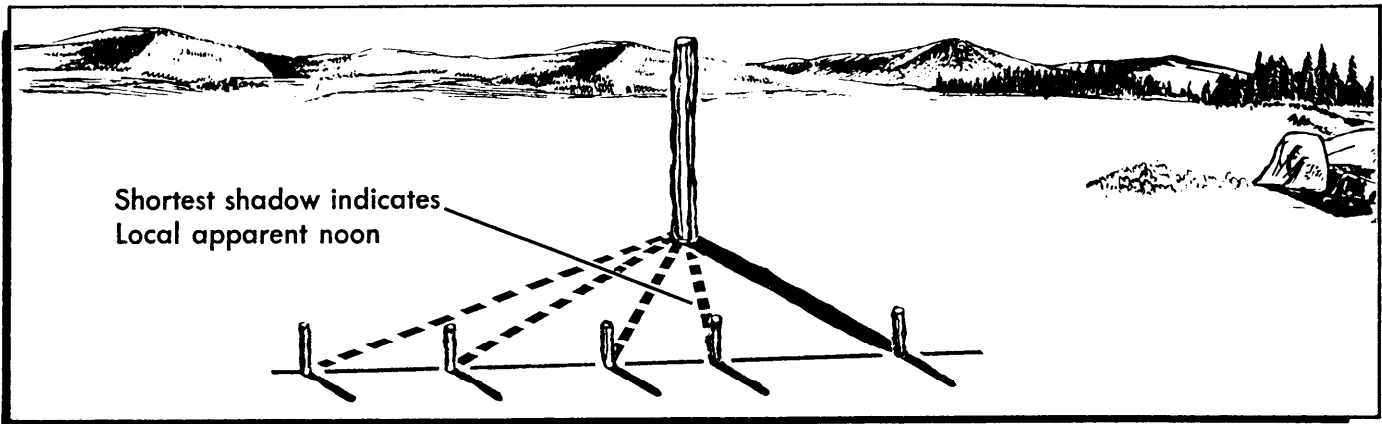

Figure 20-82. Stick and Shadow.

essary (split the difference) between the values given in the table. For example, between 45° latitude and 50° latitude is 5°. The difference in latitudes (5°) and the difference in azimuths (3°) split (1/3) is 1°2/3 (1°40'), so the more accurate degree of latitude would be 46°40' latitude.

(b) Latitude by Noon Altitude of the Sun. On any given day, there is only one latitude on Earth where the Sun passes directly overhead or through the zenith at noon. In all latitudes north of this, the Sun passes to the south of the zenith; and in those south of it, the Sun passes to the north. For each 1° change of latitude, the zenith distance also changes by 1 degree. Figure 20-80 gives the latitude for each day of the year where the Sun is in the zenith at noon. If a Weems plotter or other protractor is available, maximum altitude of the Sun should be used to find latitude by measuring the angular distance of the Sun from the zenith at noon. Local noon can be found using the methods described earlier. Stretch a string from the top of a stick to the point

where the end of the noon shadow rested, place the plotter along the string and drop a plumb line from the center of the plotter. The intersection of the plumb line with the outer scale of the plotter shows the angular distance of the Sun from the zenith.

(c) Latitudes by Length of Day. This method is used most effectively while on open seas. When in any latitude between 60°N and 60°S, the exact latitude within 30 nautical miles (1/2°) can be determined if the length of the day within 1 minute is known. This is true throughout the year except for about 10 days before and 10 after the equinoxes—approximately 11-31 March and 12 September-2 October. During these two periods, the day is about the same length at all latitudes. A level horizon is required to time sunrise and sunset accurately. Find the length of day from the instant the top of the Sun first appears above the ocean horizon to the instant it disappears below the horizon. This instant is often marked by a green flash. Write down the times of sunrise and sunset. Don't count on remembering them.

Date	Eq. of Time*	Date	Eq. of Time*	Date	Eq. of Time*	Date	Eq. of Time*	Date	Eq. of Time*	Date	Eq. of Time*
Jan. 1	-3.5 min.	Mar. 4	-12.0	May 2	+3.0 min.	Aug. 4	-6.0	Oct. 1	+10.0 min.	Dec. 1	+11.0
2	-4.0	8	-11.0	14	+3.8	12	-5.0	4	+11.0	4	+10.0
4	-5.0	12	-10.0	May 28	+3.0	17	-4.0	7	+12.0	6	+9.0
7	-6.0	16	-9.0	June 4	+2.0	22	-3.0	11	+13.0	9	+8.0
9	-7.0	19	-8.0	9	+1.0	26	-2.0	15	+14.0	11	+7.0
12	-8.0	22	-7.0	14	0.0	Aug. 29	-1.0	20	+15.0	13	+6.0
14	-9.0	26	-6.0	19	-1.0	Sept. 1	0.0	27	+16.0	15	+5.0
17	-10.0	Mar. 29	-5.0	23	-2.0	5	+1.0	Oct. 27	+16.0	17	+4.0
20	-11.0	Apr. 1	-4.0	June 28	-3.0	8	+2.0	Nov. 4	+16.4	19	+3.0
24	-12.0	5	-3.0	July 3	-4.0	10	+3.0	11	+16.0	21	+2.0
Jan. 28	-13.0	8	-2.0	9	-5.0	13	+4.0	17	+15.0	23	+1.0
Feb. 4	-14.0	12	-1.0	18	-6.0	16	+5.0	22	+14.0	25	0.0
13	-14.3	16	0.0	July 27	-6.6	19	+6.0	25	+13.0	27	-1.0
19	-14.0	20	+1.0	Aug. 28	+9.0	22	+7.0	25	+13.0	29	-2.0
Feb. 28	-13.0	Apr. 25	+2.0	Sept. 28	+9.0	25	+8.0	Nov. 28	+12.0	Dec. 31	-3.0

* Add plus values to mean time and subtract minus values from mean time to get apparent time.

Figure 20-83. Equation of Time.

Note that only the length of day counts in the determination of latitude: a watch may have an unknown error and yet serve to determine this factor. If only one water horizon is available, as on a seacoast, find local noon by the stick and shadow method. The length of day is twice the interval from sunrise to noon or from noon to sunset. Knowing the length of day, latitude can be found by using the nomogram shown in figure 20-81.

(d) Longitude from Local Apparent Noon. To find longitude, a survivor must know the correct time and the rate at which a watch gains or loses time. If this rate and the time the watch was last set is known, the correct time can be computed by adding or subtracting the gain or loss. Correct the zone time on the watch to Greenwich time; for example, if the watch is on eastern standard time, add 5 hours to get Greenwich time. Longitude can be determined by timing the moment a celestial body passes the meridian. The easiest body to use is the Sun. Use one of the following methods:

-1. Stick and Shadow. Put up a stick or rod (figure 20-82) as nearly vertical as possible in a level place. Check the alignment of the stick by sighting along the line of a makeshift plumb bob. (To make a plumb bob, tie any heavy object to a string and let it hang free. The line of the string indicates the vertical.) Sometime before midday, begin marking the position of the end of the stick's shadow. Note the time for each mark. Continue marking until the shadow definitely lengthens. The time of the shortest shadow is the time when the Sun passed the local meridian or local apparent noon. A survivor will probably have to estimate the position of

the shortest shadow by finding a line midway between two shadows of equal length, one before noon and one after. If the times of sunrise and sunset are accurately determined on a water horizon, local noon will be midway between these times.

-2. Double Plumb Bob. Erect two plumb bobs about 1 foot apart so that both strings line up on Polaris, much the same as a gun sight. Plumb bobs should be set up when Polaris is on the meridian and has no east-west correction. The next day, when the shadows of the two plumb bobs coincide, they will indicate local apparent noon.

-3. Mark Down the Greenwich Time of Local Apparent Noon. The next step is to correct this observed time of meridian passage for the equation of time; that is, the number of minutes the real Sun is ahead of or behind the mean Sun. (The mean Sun was invented by astronomers to simplify the problems of measuring time. Mean Sun rolls along the Equator at a constant rate of 15° per hour. The real Sun is not so considerate; it changes its angular rate of travel around the Earth with the seasons.) Figure 20-83 gives the value in minutes of time to be added to or subtracted from mean (watch) time to get apparent (Sun) time.

-4. After computing the Greenwich time of local noon, the difference of longitude between the survivor's position and Greenwich can be found by converting the interval between 1200 Greenwich and the local noon from time to arc. Remember that 1 hour equals 15° of longitude, 4 minutes equal 1° of longitude, and 4 seconds equal 1' of longitude. Example: The

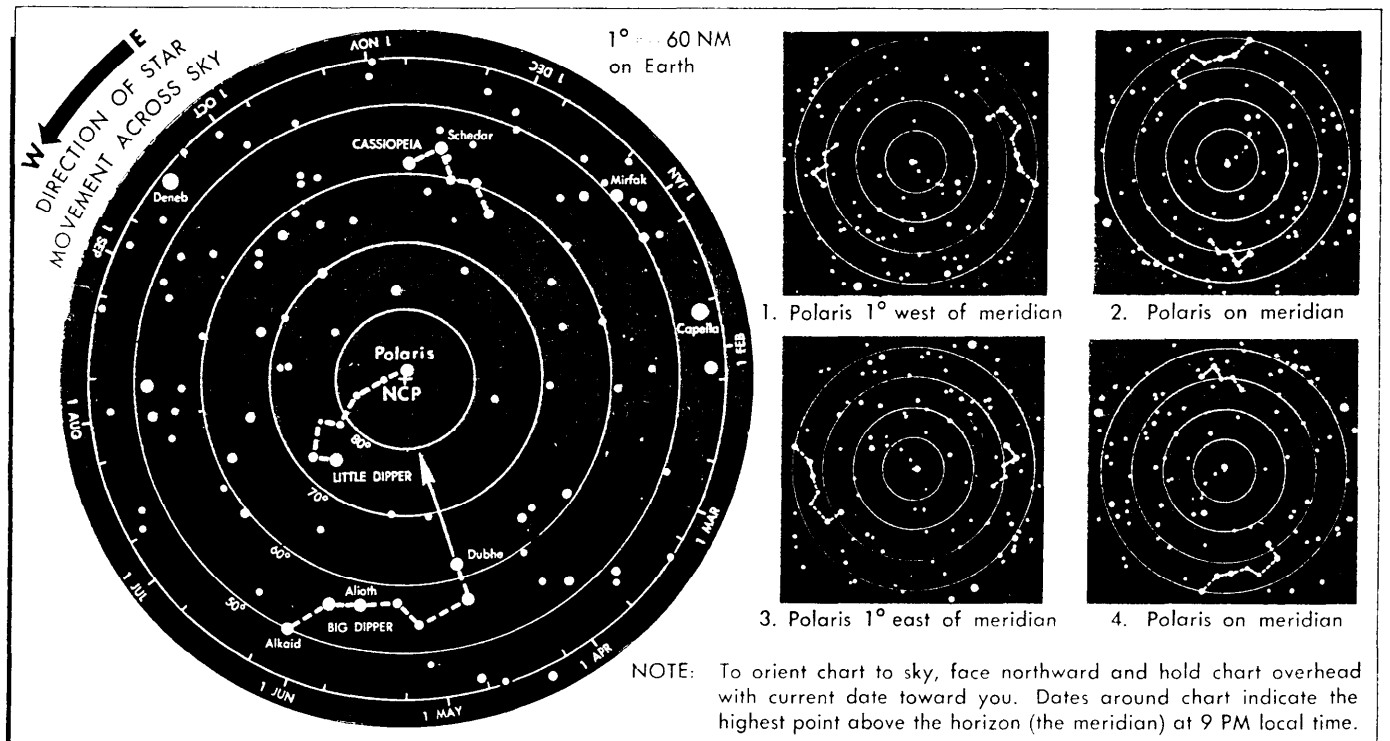

Figure 20-84. Finding Direction from Polaris.

survivor's watch is on eastern standard time, and it normally loses 30 seconds a day. It hasn't been set for 4 days. The local noon is timed at 15:08 on the watch on 4 February. Watch correction is 4 X 30 seconds, or plus 2 minutes. Zone time correction is plus 5 hours. Greenwich time is 15:08 plus 2 minutes plus 5 hours or 20:10. The equation of time for 4 February is minus 14 minutes. Local noon is 20:10 minus 14 minutes or 19:56 Greenwich. The difference in time between Greenwich and present position is 19:56 minus 12:00 or 7:56. A time of 7:56 equals 119° of longitude. Since local noon is later than Greenwich noon, the survivor is west of Greenwich, longitude is 119°W.

(e) Direction and Position Finding at Night:

-1. Direction from Polaris. In the Northern Hemisphere, one star, Polaris (the Pole Star), is never more than approximately 1° from the North Celestial Pole. In other words, the line from any observer in the Northern Hemisphere to the Pole Star is never more than 1° away from true north. Find the Pole Star by locating the Big Dipper or Cassiopeia, two groups of stars which are very close to the North Celestial Pole. The two stars on the outer edge of the Big Dipper are called pointers because they point almost directly to Polaris. If the pointers are obscured by clouds, Polaris can be identified by its relationship to the constellation Cassiopeia. Figure 20-84 indicates the relation between the Big Dipper, Polaris, and Cassiopeia.

-2. Direction from the Southern Cross. In the Southern Hemisphere, Polaris is not visible. There the Southern Cross is the most distinctive constellation.

When flying south, the Southern Cross appears shortly before Polaris drops from sight astern. An imaginary line through the long axis of the Southern Cross, or True Cross, points toward the South Pole. The True Cross should not be confused with a larger cross nearby known as the False Cross, which is less bright and more widely spaced. Two of the four stars in the True Cross are among the brightest stars in the heavens; they are the stars on the southern and eastern arms. Those of the northern and western arms are not as conspicuous but are bright.

-3. There is no conspicuous star above the South Pole to correspond to Polaris above the North Pole. In fact, the point where such a star would be, if one existed, lies in a region devoid of stars. This point is so dark in comparison with the rest of the sky that it is known as the Coalsack. Figure 20-85 shows the True Cross and—to the west of it—the False Cross.

(f) Finding Due East and West by Equatorial Stars. Due to the altitude of Polaris above the horizon, it may sometimes be difficult to use as a bearing. To use a point directly on the horizon may be more convenient.

-1. The celestial equator, which is a projection of the Earth's equator onto the imaginary celestial sphere, always intersects the horizon line at the due east and west points of the compass. Therefore, any star on the celestial equator rises due east and sets due west (disallowing a small error because of atmospheric refraction). This holds true for all latitudes except those of the North and South Poles, where the celestial equator

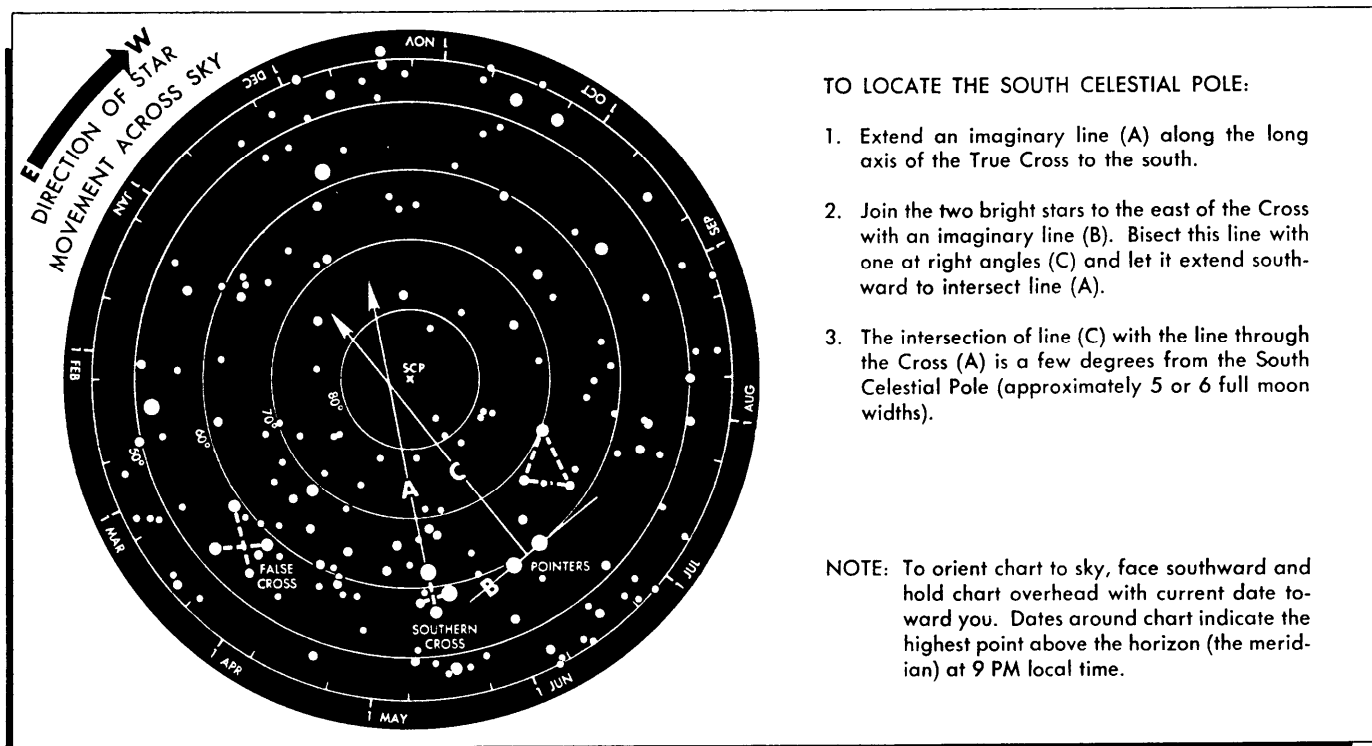

Figure 20-85. Finding Direction from Southern Cross.

and the horizon have a common plane. However, if a survivor is at the North or South Pole, it will probably be known, so this technique can be assumed to be of universal use.

-2. Certain difficulties arise in the practical use of this technique. Unless a survivor is quite familiar with the constellations, it may be difficult to spot a specific rising star as it first appears above the eastern horizon. It will probably be simpler to depend upon the identification of an equatorial star before it sets in the west.

-3. Another problem is caused by atmospheric extinction. As stars near the horizon, they grow fainter in brightness because the line of sight between the observer's eyes and the star passes through a constantly thickening atmosphere. Therefore, faint stars disappear from view before they actually set. However, a fairly accurate estimate of the setting point of a star can be made some time before it actually sets. The atmospheric conditions of the area have a great effect on obstructing a star's light as it sets. Atmospheric haze, for example, is much less a problem on deserts than along temperate zone coastal strips.

-4. Figure 20-86 shows the brighter stars and some prominent star groups which lie along the celestial equator. There are few bright stars actually on the celestial equator. However, there are a number of stars which lie quite near it, so an approximation within a degree or so can be made. Also, a rough knowledge of the more conspicuous equatorial constellations will give the survivor a continuing checkpoint for maintaining orientation.

(g) Finding Latitude from Polaris. A survivor can find the latitude in the Northern Hemisphere north of 10°N by measuring the angular altitude of Polaris above the horizon, as shown in figure 20-87.

(h) Finding Direction (North) from Overhead Stars that are not in the General Location of the Celestial Poles:

-1. At times, survivors may not be able to locate Polaris (the North Star) due to partial cloud cover, or its position below the observer's horizon. In this situation, it would seem that survivors would be unable to locate direction. Fortunately, survivors who wish to initially find direction or who wish to check a course of

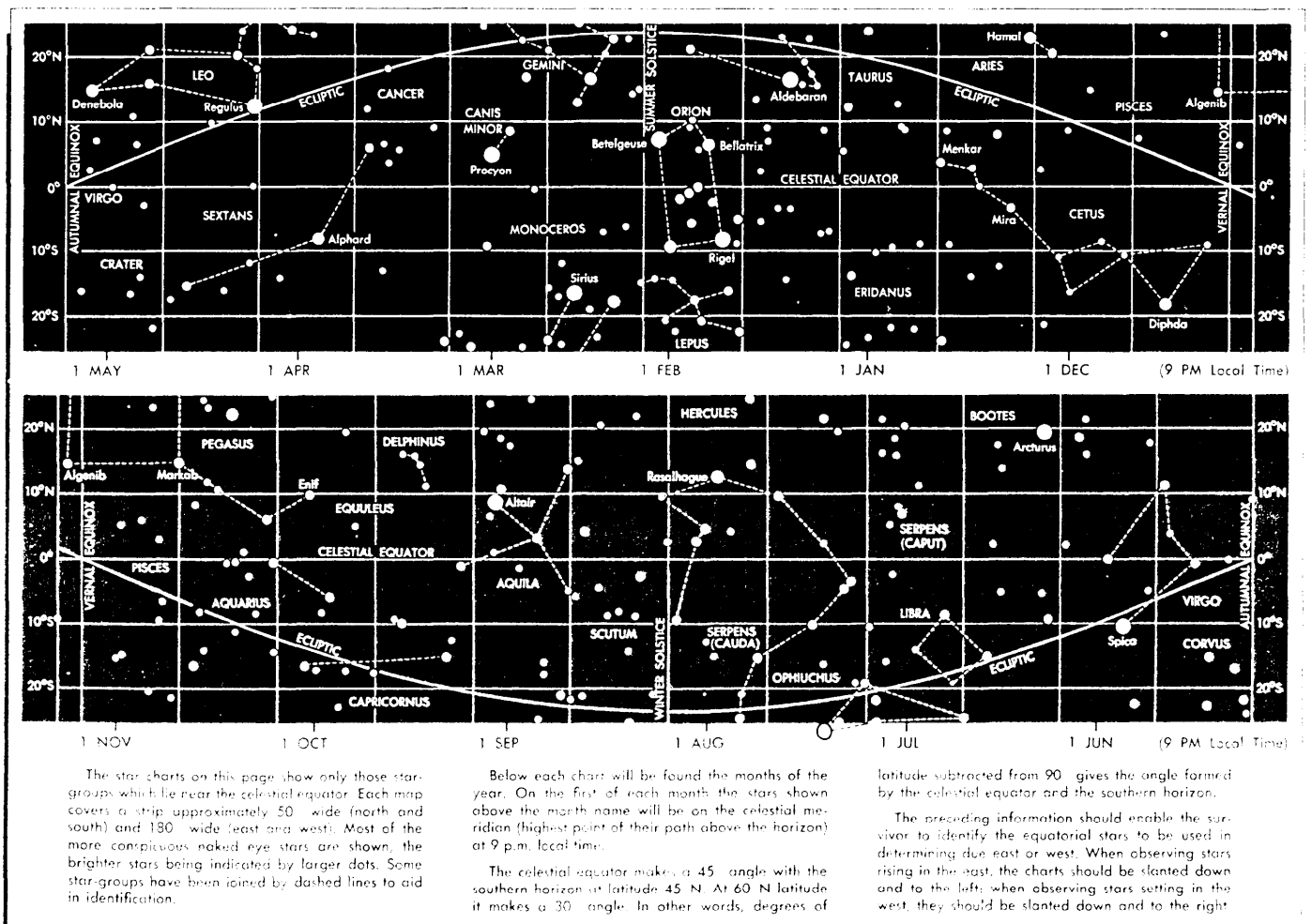
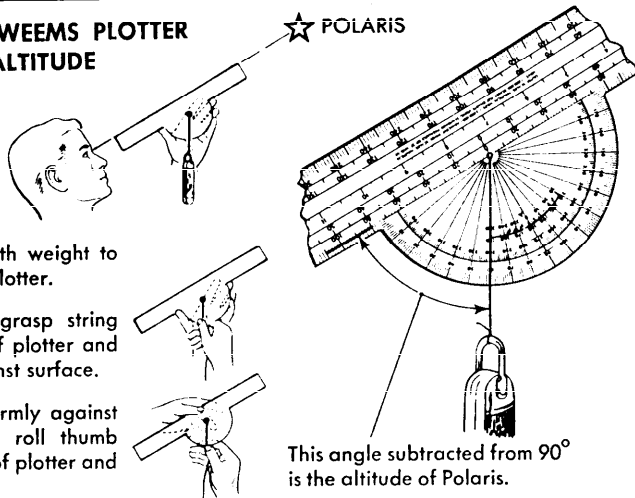

Figure 20-86. Charts of Equatorial Stars.

HOW TO USE WEEMS PLOTTER TO MEASURE ALTITUDE OF POLARIS

1. Attach string with weight to center hole of plotter.
2. After sighting, grasp string at outer edge of plotter and hold firmly against surface.
3. Holding string firmly against face of plotter, roll thumb under the edge of plotter and take reading.



HOW TO USE ANY PROTRACTOR TO MEASURE ALTITUDE OF POLARIS

- Any protractor (such as the one printed in AFM 64-5) can be used to find latitude.
1. Attach string with weight to Point "P".
 2. After sighting, grasp string at edge of protractor.
 3. Hold string in this position and take reading. This gives the altitude of Polaris.

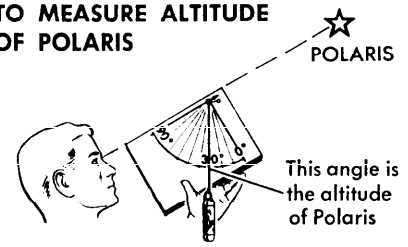

CORRECTION FOR OBSERVED ALTITUDE OF POLARIS

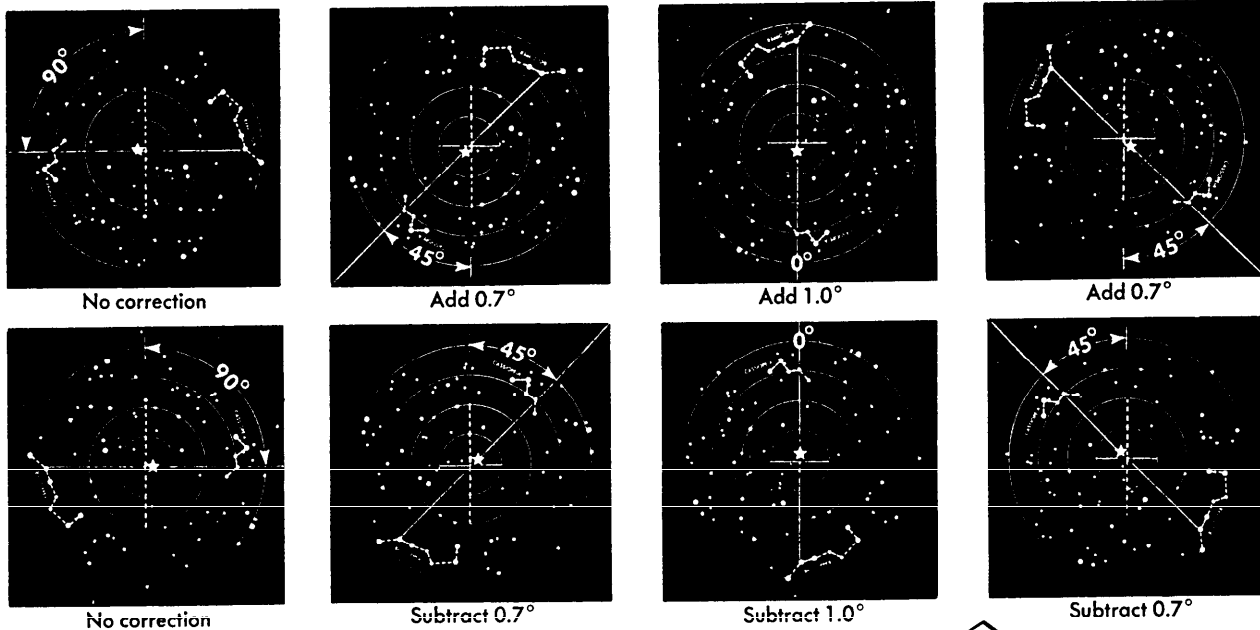

The star diagrams above are drawn for angles of 0°, 45°, and 90° between the vertical dotted line thru the pole and the line thru Cassiopeia and the Big Dipper (Ursa Major). For intermediate positions the angle may be estimated and the correction taken from the Correction Table. Subtract corrections given in the table when Polaris is above the horizontal line thru the pole and add corrections when Polaris is below this line.

Note that the correction changes very slowly near the time when the correction is greatest and hence an error in estimation of the position has little effect at this time.

CORRECTION TABLE			
ANGLE	CORRECTION	ANGLE	CORRECTION
0°	1.0°	50°	0.6°
10°	1.0°	60°	0.5°
20°	0.9°	70°	0.3°
30°	0.9°	80°	0.2°
40°	0.8°	90°	No correction

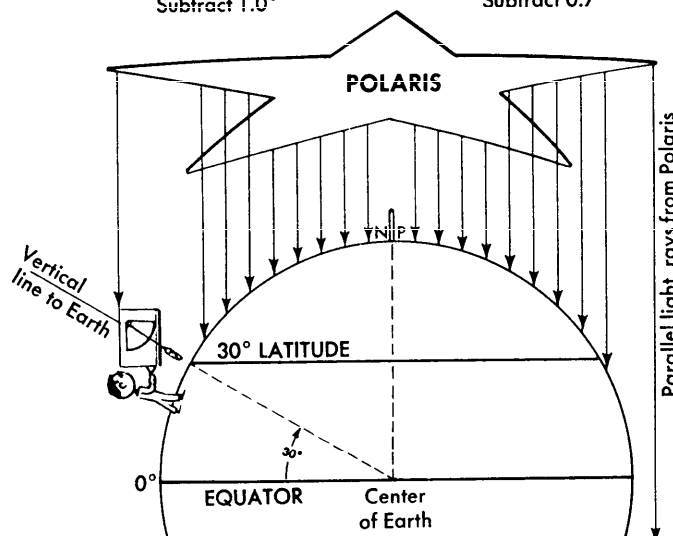

Figure 20-87. Finding Latitude by Polaris.

travel during the night need not worry about being lost or unable to travel if Polaris cannot be identified.

-2. The following is an adaptation of the stick and shadow method of direction finding. This method is based on the principles that all the heavenly bodies (Sun, Moon, planets, and stars) rise (generally) in the east and set (generally) in the west. This technique can be used anywhere on Earth with any stars except those which are circumpolar. Circumpolar stars are those which appear to travel around Polaris instead of apparently "moving" from east to west.

-3. To use this technique, survivors should keep in mind that they may use *any star other than a circumpolar one*.

-4. Survivors who wish to know general direction must prepare a device to aid them. This can be done by placing a stick (about 5 feet in length) at a slight angle in the ground in an open area (figure 20-88). Thin material (suspension line, string, vine, braided cloth, etc.) is then attached to the tip of the stick. This material should be longer than what is required to reach the ground (figure 20-88).

-5. The survivor should lie on the back with the head next to this hanging line and pull the cord up to the temple area and hold it tautly.

-6. Next, the survivor moves around on the ground until the taut line is pointing directly at the selected, bright, noncircumpolar star (or planet).

-7. The taut line is now in position to simulate the star's (or planet's) shadow. Survivors should remember that this method of finding direction is an adaptation of the Sun, stick, and shadow approach. Here the more distant stars and (or) planets take the place of our Sun. Since these objects are too distant from the Earth to create shadow, the string represents the shadow.

-8. With the taut line simulating the star's shadow, survivors should mark the point on the ground where the line touches with a stick, stone, etc. The survivor should repeat this sighting on the same star (or planet) after about 15 to 20 minutes (marking the spot at which the line "shadow" touches the ground). A line scribed on the ground which connects these two points will run west-east (as the stars and planets move from east to west, the "shadow" will move in the opposite direction). The first mark will be in the west. Drawing a line perpendicular to the west-east line, a survivor will have a north-south line and be able to travel.

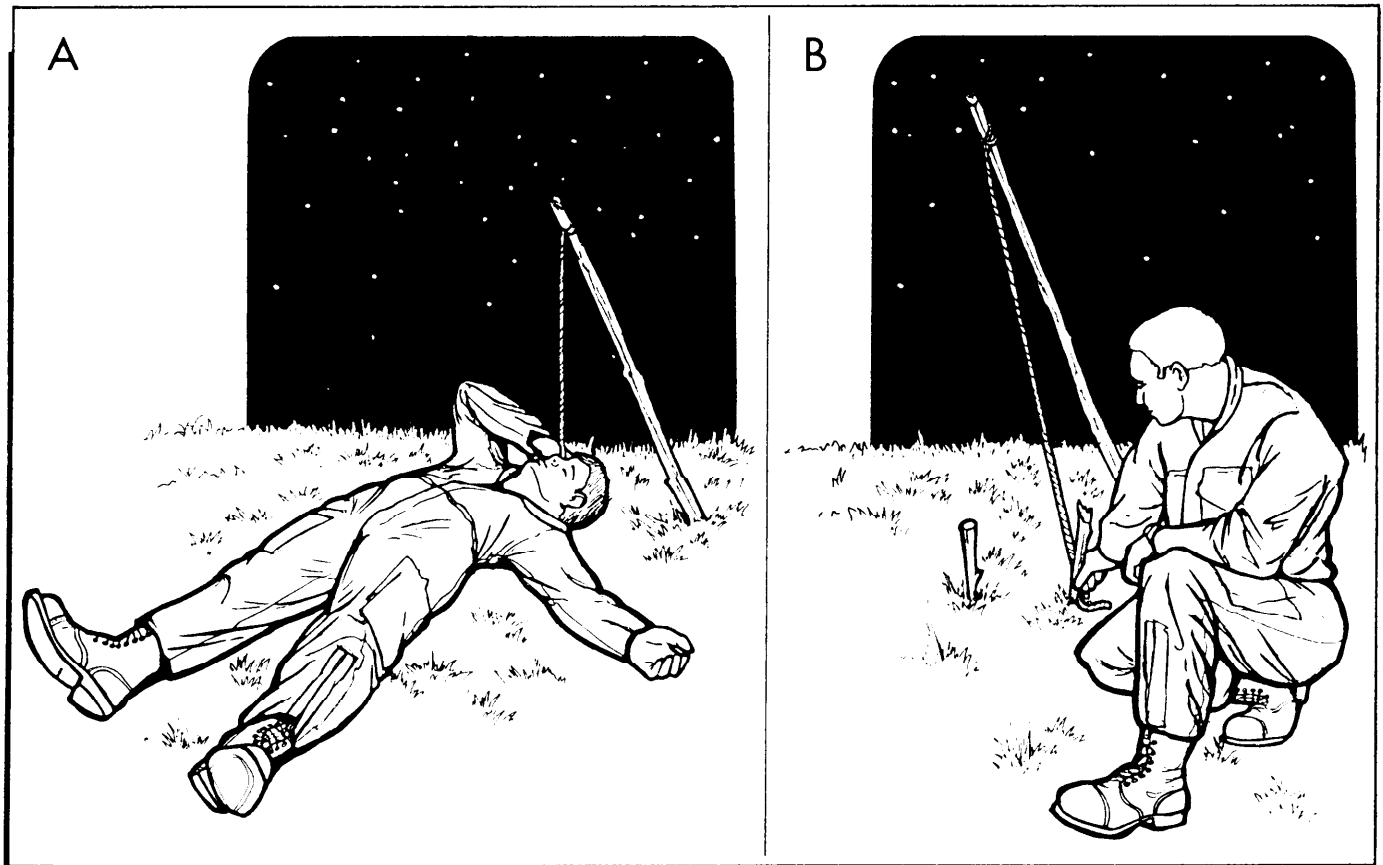

Figure 20-88. Stick and String Direction Finding.